

VEO



FERMAX

KIT VIDEO DUOX PLUS CITYLINE VEO WIFI
DUOX PLUS CITYLINE WIFI VEO VIDEO KIT
KIT VIDÉO DUOX PLUS CITYLINE VEO WIFI
DUOX PLUS CITYLINE WIFI VEO VIDEO-SET
KIT VÍDEO z PLUS CITYLINE VEO WIFI

GUÍA INICIO RÁPIDA
QUICK START GUIDE
GUIDE DE MISE EN MARCHE RAPIDE
SCHNELLSTARTANLEITUNG
GUIA DE INICIAÇÃO RAPIDA



INSTALACIÓN

INSTALACIÓN DE LA PLACA EN LA CALLE Y DEL MONITOR

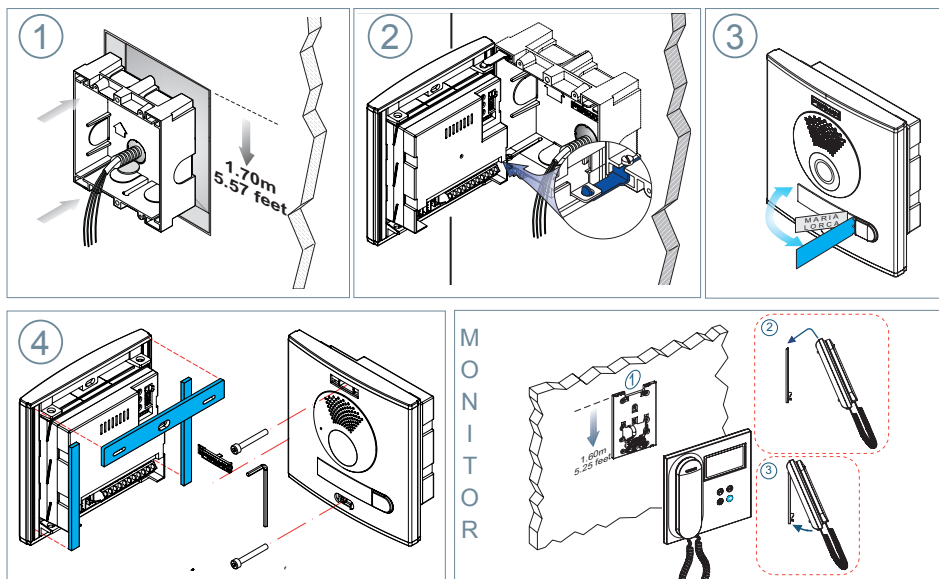

CONFIGURACIÓN



MONITOR VEO WIFI DUOX PLUS

El monitor suministrado en el kit YA SALE PROGRAMADO de fábrica.

En el caso del kit de 2 líneas ambos monitores SALEN PROGRAMADOS.

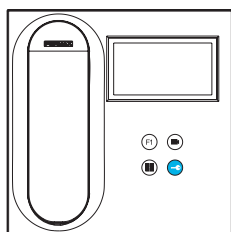
BOTONES CONTROL



-  Menú digital para ajustes y configuración de parámetros internos. (Si el monitor está programado).
-  En conversación, pulsar para abrir la puerta.
En reposo, llamada al conserje (si existe conserjería).
-  Función auxiliar (consulte con su instalador).
En reposo, pulsar y se visualiza en pantalla la posibilidad de realizar autoencendido con diferentes placas. Pulsando secuencialmente Placa 0, Placa 1, Placa General, (según disponibilidad de placas).

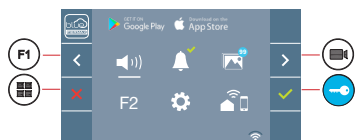

El monitor VEO WIFI incorpora un menú OSD que se gestiona a través de los pulsadores del monitor. Los iconos visualizados en pantalla se manejan con los pulsadores correspondientes ubicados en el monitor.



La línea blanca abajo del icono indica en la función en la que nos encontramos.

Seleccionar con  /  el icono deseado y confirmar con .

AJUSTES

1. AJUSTES DE MONITOR

AJUSTES VIDEO

Teniendo imagen en el monitor al pulsar el botón , (o al recibir una llamada sin descolgar), pulsar la tecla  para mostrar los **ajustes de video**.

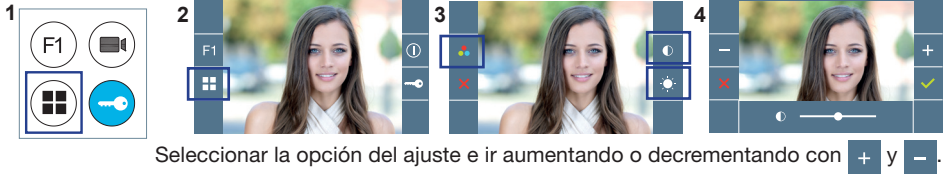

AJUSTES AUDIO

Durante el tiempo que está abierto el canal de audio pulsar el botón  y aparecerá en pantalla el menú para dicho ajuste.

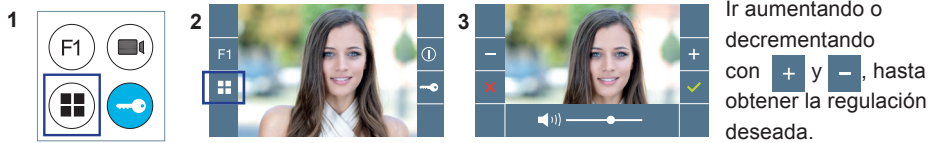

Nota: Tiempo de conversación máximo: 90 segundos.

2. AJUSTES PLACAS

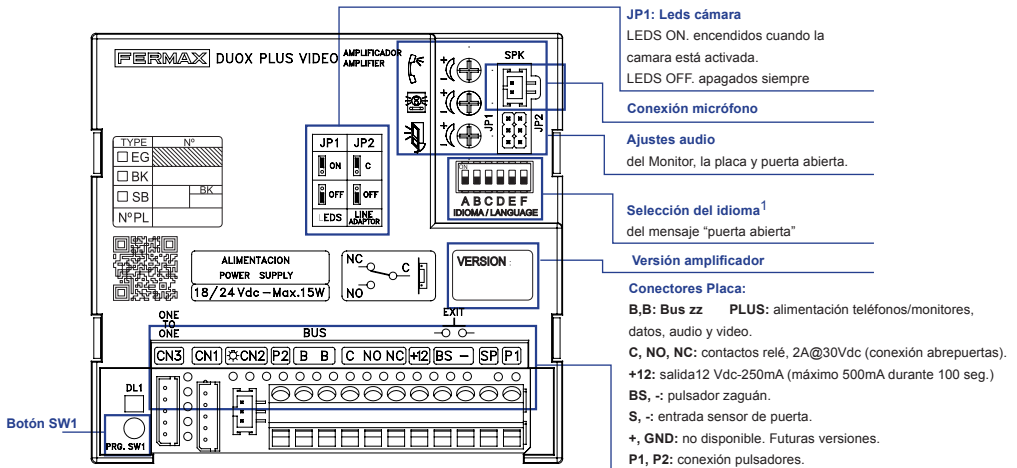

¹ Selección del idioma del mensaje "puerta abierta"

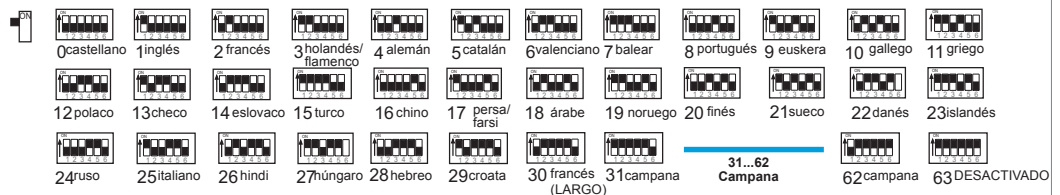

3. CODIFICAR PLACAS*

Siempre que exista más de una placa, será necesario programar el número de placas.

4. ENFOQUE DE LA CÁMARA / TIEMPO ACTIVACIÓN DEL ABREPUERTAS*

Para ajustar la imagen de la cámara o ajustar el tiempo de activación del abrepuertas.

* Ver Configuración asistida por voz en placas de pulsadores cod. 970048. Instrucción incluida en este equipo.



CARACTERÍSTICAS TÉCNICAS

CARACTERÍSTICAS TÉCNICAS PLACA

Alimentación	18-24 Vdc
Consumo en reposo	2,86 W
Consumo audio activo	6,30 (max) W
Potencia audio sentido vivienda-calle	1 W
Potencia audio sentido calle-vivienda	0,15 W
Temperatura de funcionamiento	[-25° , +70°C] / [-13° , 158°F]
Volumen regulable en ambos sentidos	

VALORES PLACA

Tiempo activación abrepuertas	01...99 seg. (por defecto: 03)
Tiempo activación botón salida	00...99 seg. (por defecto: 06) / (desactivado: 00)
Tipo de placa	sub-bloque/bloque/entrada general. (por defecto: bloque)
Número de placa	0...9 (por defecto: 00)
Placa MÁSTER	

CARACTERÍSTICAS TÉCNICAS MONITOR (Pantalla OSD TFT 4,3")

Alimentación	18-24 Vdc
Consumo en reposo	1,3 W
Consumo máximo	5,6 W
Temperatura de funcionamiento	[-5° , +40°C] / [23° , 104°F]



ESQUEMAS

TABLA SECCIONES - DISTANCIAS

Tablas secciones distancias - INSTALACIÓN DE KITS de VIDEO

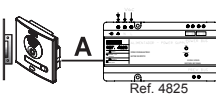
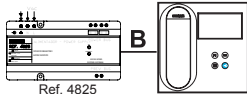
SECCIÓN CABLE			
	TERMINALES por vivienda sin fuentes adicionales	Distancia máxima (A) Fuente/Filtro hasta Placa (Placa-Abrepuertas) (i)	Distancia máxima (B) Fuente/Filtro hasta el Terminal más alejado
2 x 1 mm ²	1	250	250
	2		200
	3		150
2 x 0,5 mm ²	1	200	200
	2		120
	3		70
2 x 0,2 mm ²	1	80	100
	2		50
	3		30

- (i) Para abrepuertas de 12Vdc y consumo máx. 250mA, alimentador desde el amplificador.

Nota: Para un funcionamiento óptimo, se recomienda utilizar el mismo tipo de cable para toda la instalación. No duplicar hilos.

ESQUEMA CABLEADO KIT 1 LÍNEA

Ejemplo: Conexión de abrepuertas de corriente continua.

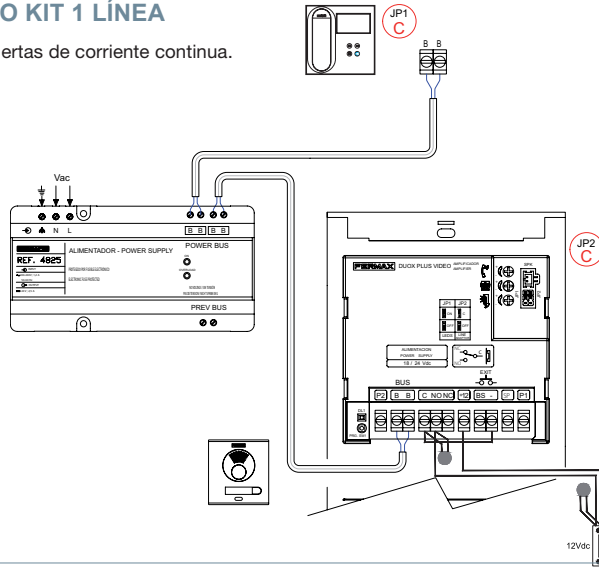

ESQUEMA CABLEADO KIT 2 LÍNEAS

Ejemplo: Conexión abrepuertas de corriente alterna.

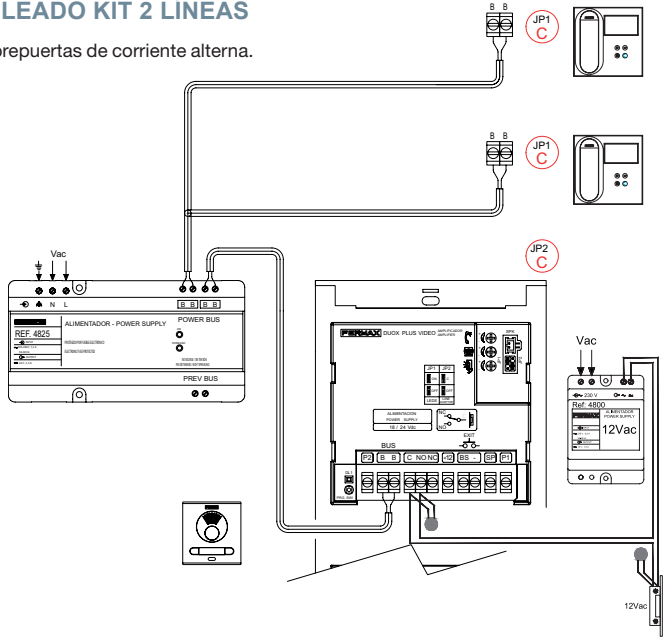

Nota: Este documento muestra los conceptos más básicos para la rápida puesta en marcha, para más información descargar los manuales en www.fermax.com

- Placas Cityline Video Duox Plus cod. 970050.
- Monitor Duox Plus Veo WIFI cod. 970166.
- Libro Técnico Duox Plus cod. 970122.



AJUSTES DE USUARIO

1. EMPAREJAMIENTO. Desvío de llamada.

El monitor VEO WIFI DUOX PLUS permite acceder a nuevos servicios ofrecidos por Fermax a través de su propia nube como el de desvío de llamada. Para poder disfrutar de dicho servicio el primer paso es conectar el monitor a Internet mediante el proceso llamado de emparejamiento.

Para ello es preciso usar la app Blue que está disponible en Google Play o Apple Store.

Ajustes del monitor. Proceso de emparejamiento.

Con ayuda de la app Blue y una vez registrado el usuario y logueado podemos empezar el proceso de emparejamiento del monitor.

El monitor DUOX PLUS sólo es compatible con WIFI 2,4GHz.

Pasos para conectar el monitor a internet.



Android

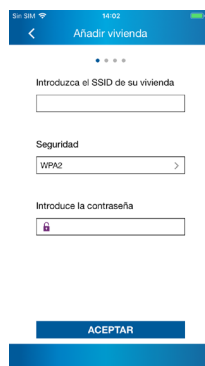
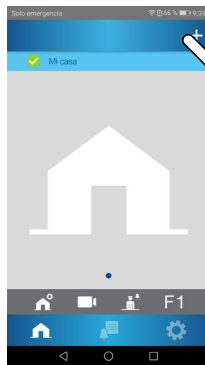

iOS

- 1 Abra la aplicación e inicie sesión.
- 2 Haga clic en el botón **+** en el centro de la pantalla por defecto o en la parte superior derecha si ya había algunas viviendas disponibles.

- 3 La aplicación requerirá que el usuario seleccione la red WIFI deseada para conectar el monitor.

Seleccione (en caso de Android) o introduzca (en caso de iOS) el SSID (nombre de la red) deseada, escriba la contraseña correcta para conectarse y haga clic en SIGUIENTE/ ACEPTAR.

- 4 La aplicación requerirá que el usuario abra el menú de conectividad en el monitor:



- 4a Pulsar el botón **MENÚ** , se accede a la pantalla del Menú de Usuario.

4b Correspondencia entre pulsadores y menú de navegación. La línea blanca abajo del icono indica en la función en la que nos encontramos.

4c Seleccionar el menú de conectividad en el monitor.

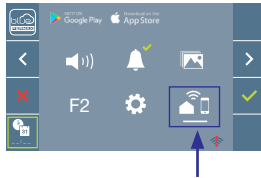
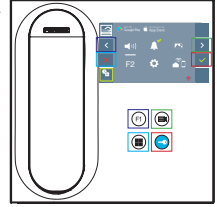

5 Una vez seleccionado el menú de conectividad, confirme con para entrar en él.

Haga clic en SIGUIENTE, una vez listo.



6 El monitor mostrará un código QR en la pantalla.

Se proporciona la MAC en pantalla por si el router wifi tiene filtro de MAC.



7 La aplicación estará lista para escanear dicho código. Apunte al QR en la pantalla del monitor con el móvil alineando con el cuadrado verde en la pantalla del móvil.

8 La aplicación y el monitor comenzarán a sincronizarse entre sí. El led blanco WIFI del monitor comenzará a parpadear.

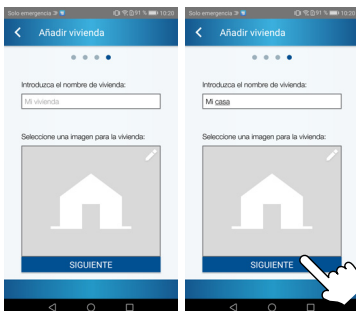
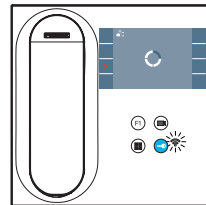
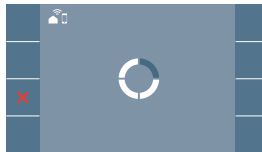

9 Se visualiza la pantalla para añadir la vivienda:

- Nombre
- Imagen (opcional)

Introducir datos y pulsar SIGUIENTE.



- 11 Si la red WIFI y las credenciales proporcionadas son correctas, el monitor se conectará a Internet y el proceso se completará con éxito.



- 12 La aplicación mostrará la nueva vivienda vinculada como disponible y conectada (tick verde ✓) y el monitor mostrará el resultado de la conexión como exitoso. El led blanco WIFI permanecerá encendido ahora.



Mensaje de **confirmación** en el proceso de emparejamiento del monitor.

Si no se realiza correctamente, mensaje de **error** en el proceso de emparejamiento del monitor.

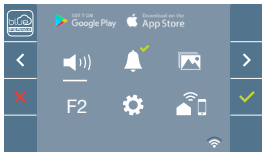

- 13 Una vez conectado, si se abre nuevamente el menú de usuario en el monitor, mostrará la intensidad de la señal WIFI en la parte inferior derecha.

Niveles de intensidad del icono de señal wifi mostrado en el menú:



Entre 0% y 20% o monitor no emparejado.



Entre 20% y 40%



Entre 40% y 60%



Entre 60% y 80%



Entre 80% y 100%

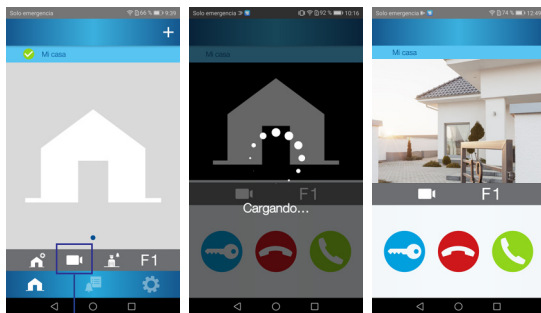



Autoencendido

- 14 Para probar el desvío de llamadas, el usuario puede realizar un autoencendido y ver que se conecta con la placa de calle, (siempre y cuando no esté en uso).

Ajustes parámetros de usuario:
 RESET DE USUARIO:
 Un reset de usuario devuelve el estado del monitor a no emparejado (desconectado de Internet).

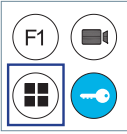

Nota: Este capítulo presenta los conceptos más básicos para la rápida puesta en marcha, para más información descargar el manual **Aplicación DUOX PLUS Blue para móvil cod. 970156** en www.fermax.com.

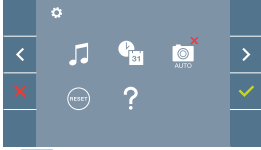
2. PARÁMETROS DE USUARIO: Acceder a la pantalla Parámetros de usuario.

1  2  3 



2.1 Ajustes Fecha y Hora



2.2 Captura Imágenes

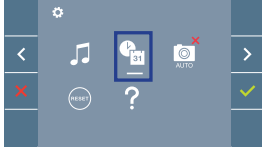
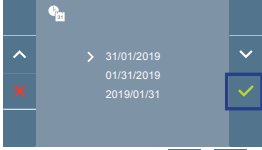

Seleccionar con  el icono  y confirmar con .





2.1 AJUSTES DE FECHA Y HORA

El monitor WIFI sincroniza la hora automáticamente con la zona horaria donde se encuentre instalado siempre que esté emparejado y conectado a Internet. En ese caso no se permite modificar la fecha ni la hora.

1  2  3 

Seleccionar con  el icono  y confirmar con .

Seleccionar con   el formato de fecha. Una vez seleccionada confirmar con .

Seleccionar la fecha y la hora con   y confirmar . Para navegar por los ajustes .

Fecha sin programar: 01/01/2019 (por defecto). El icono  aparecerá indicando que la fecha no es correcta (fecha por defecto). Al perder la alimentación vuelve a la fecha por defecto.

Nota: Si se captura una imagen con la fecha sin programar mostrará el icono .

Iconos de notificación de fecha sin programar:

Pantalla Menú de usuario

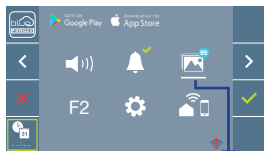

Visualización de imágenes

Pantalla Comunicación



Pantalla Visualización de imágenes

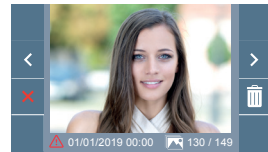



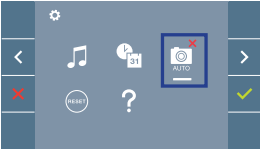
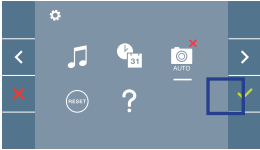
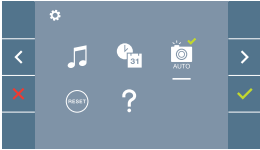

2.2 ACTIVACIÓN / DESACTIVACIÓN CAPTURA DE IMÁGENES

El monitor puede realizar una foto automática a los 3 segundos de recibir una llamada de una placa de calle. Por la legislación de protección de datos ((EU) 2016/679) de la Unión Europea puede restringirse la captura de imágenes. Por defecto está desactivada, se puede activar desde el monitor bajo su responsabilidad.

Así mismo podría obligar a colocar junto a la placa de calle un cartel indicando que el monitor puede capturar imágenes. Puede descargarlo en <https://www.fermax.com/spain/fermax/corporate/utilidades.html>.

1  2  3 

Seleccionar con  el icono  y confirmar con .

Pulsar  para activar/desactivar la función.

✂ INSTALLATION

INSTALLATION OF OUTDOOR PANEL AND MONITOR

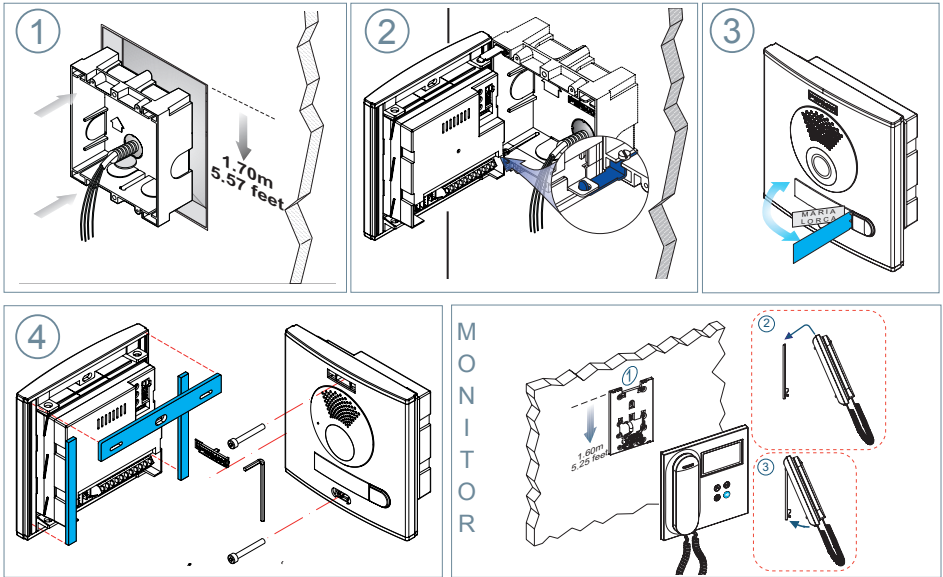





🏠 CONFIGURATION

DUOX PLUS WIFI VEO MONITOR

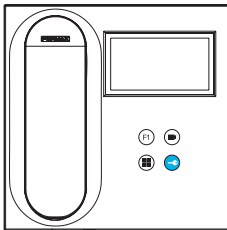
The monitor supplied in the kit comes **PRE-PROGRAMMED** from the factory.
If the kit has 2 lines, both monitors, they are **PRE-PROGRAMMED**.

CONTROL BUTTONS



-  Digital menu for internal parameter settings and configuration. (When the monitor has already been programmed)
-  In conversation, press to open the door.
In standby, call to guard unit (if applicable).
- F1** Auxiliary function, (contact your installer).
In standby, press and it displays the option of auto-on with different panels. By sequentially pressing Panel 0, Panel 1, General Panel, (depending on the available panels).
- 

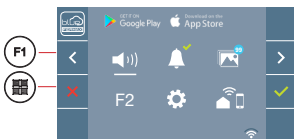

WIFI VEO monitor incorporates an OSD menu that is managed via the monitor's push buttons. The icons displayed are managed with the corresponding buttons located on the monitor.



The white line at the bottom of the icon indicates the function that is currently in effect.

Select with  /  the desired icon and confirm with .

SETTINGS

1. MONITOR SETTINGS

VIDEO SETTINGS

With an image on the monitor, by pressing the button , (or upon receiving a call without establish communication), press the  key to show the video settings.

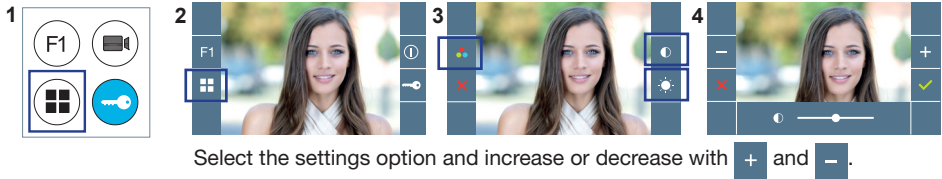

AUDIO SETTINGS

While the audio channel is open, press the  button and a menu screen appears for this setting.

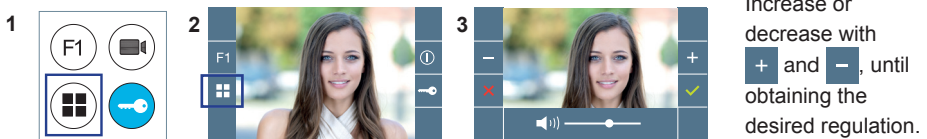

Notice: Maximum conversation time: 90 seconds.

2. PANEL SETTINGS

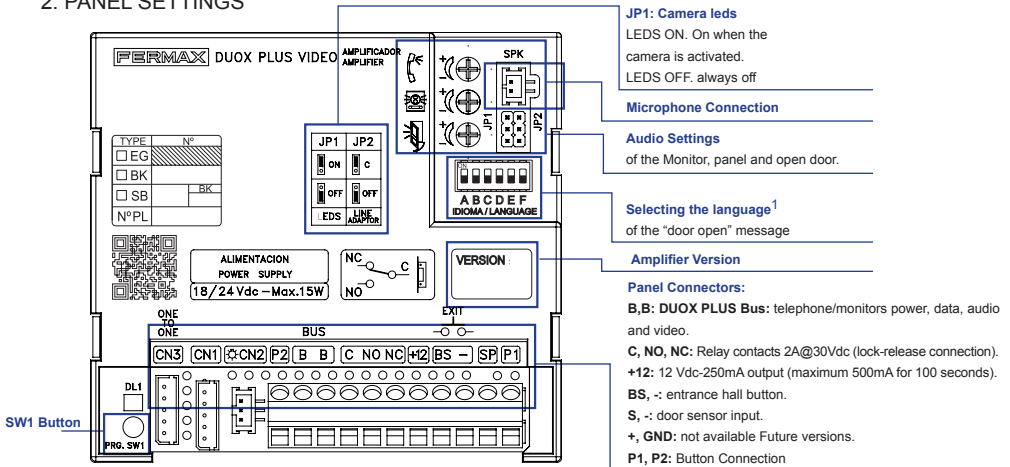

¹Door open¹ warning language selection

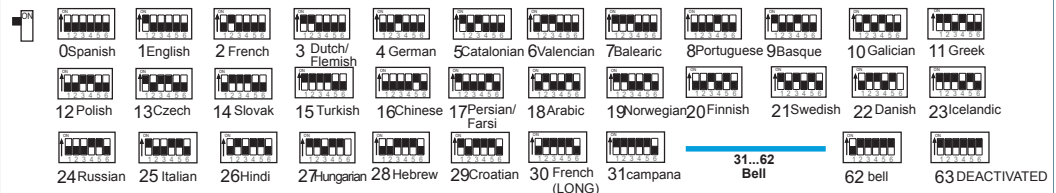

3. ENCODING PANELS*

Whenever there is more than one panel, you must program the number of panels.

4. CAMERA FOCUS / LOCK RELEASE ACTIVATION TIME*

To adjust the camera image or adjust the lock-release activation time.

* See Voice assisted configuration in button panels cod. 970048. Instructions included with this equipment.

TECHNICAL FEATURES

PANEL TECHNICAL CHARACTERISTICS

Power Supply	18-24 Vdc
Standby Consumption	2,86 W
Audio active consumption	6,30 (max) W
Audio Power in Residence - Entry Panel Direction	1 W
Audio Power in Entry Panel - Residence Direction	0.15 W
Operating temperature	[-25° , +70°C] / [-13° , 158°F]
Volume can be Regulated in Both Directions.	

PANEL VALUES

Lock-release activation time	01...99 sec. (Default: 03)
Exit button activation time	00...99 sec. (Default: 06) / (deactivated: 00)
Panel type	sub-block/block/general entrance. (Default: block)
Panel number	0..9 (by default: 00)
MASTER panel	

MONITOR TECHNICAL CHARACTERISTICS(OSD TFT 4,3" Screen)

Power supply	18-24 Vdc
Standby consumption	1,3 W
Maximum consumption	5,6 W
Operating temperature	[-5° , +40°C] / [23° , 104°F]

WIRING DIAGRAMS

SECTIONS-DISTANCES TABLE

Distance section table - VIDEO KIT INSTALLATION			
SECTION CABLE	TERMINALS per home without additional power source	Maximum distance (A) Source / Filter up to Panel (Panel-Lock release) (i)	Maximum distance (B) Source/Filter up to Panel Furthest terminal
2 x 1 mm ²	1	250	250
	2		200
	3		150
2 x 0,5 mm ²	1	200	200
	2		120
	3		70
2 x 0,2 mm ²	1	80	100
	2		50
	3		30

- (i) For the 12Vdc lock-release and max. consumption 250mA, powered by the amplifier.

Notice: For optimal performance, we recommend using the same type of cable throughout the installation. Do not double wires.

1 LINE WIRING DIAGRAM KIT

Example: Direct current lock release connection.

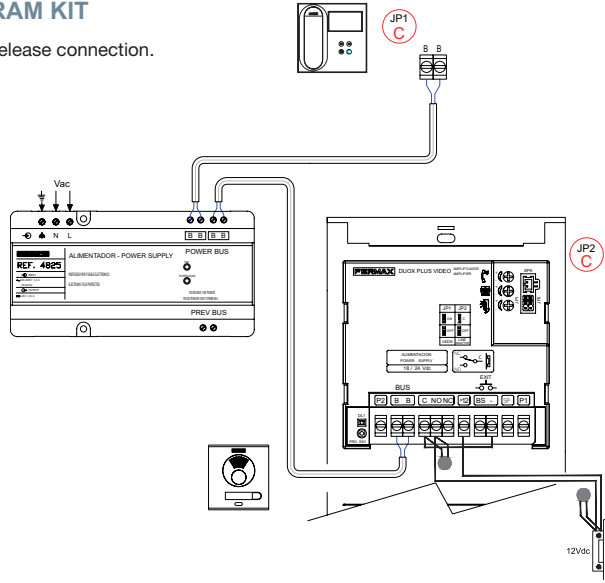

2 LINES WIRING DIAGRAM KIT

Example: Alternative current lock release connection.

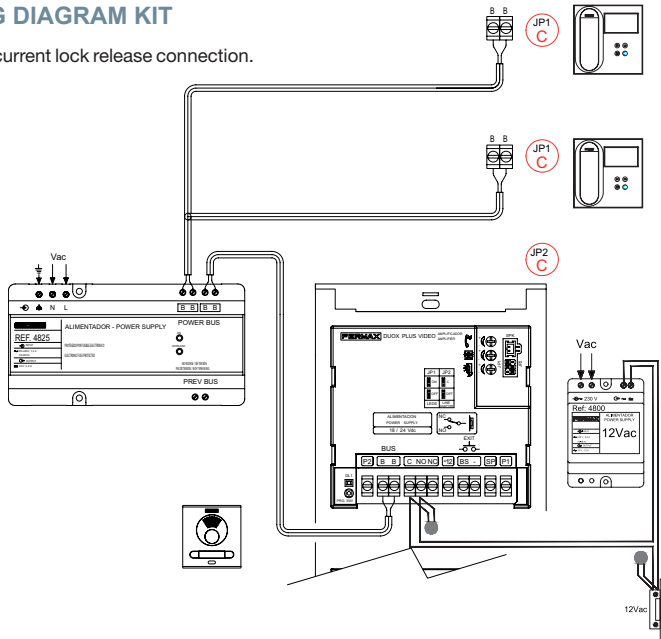

Notice: This document shows the basic concepts for a quick start-up. For more information download the manuals at www.fermax.com

- Cityline Video Duox Plus Panels cod. 970050.
- Duox Plus WIFI VEO Monitor cod. 970166.
- Duox Plus Technical Book cod. 970122.



USER SETTINGS

1. PAIRING. Call divert.

The VEO WIFI DUOX PLUS monitor allows access to new services offered by Fermax using its own cloud such as call forwarding. In order to enjoy this service the first step is to connect the monitor to the Internet via a process called pairing.

To do this you need to use the Blue app that is available on Google Play or Apple Store.

Monitor settings. Pairing process.

Once the Blue app is downloaded and the user has registered and logged in, we can start the process of pairing the monitor.

The DUOX PLUS monitor only supports 2.4GHz WIFI.

Steps to connect the monitor to the internet.



- 1 Open the application and log in.

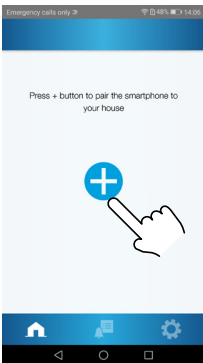

- 2 Click on the button **+** in the centre of the default screen or on the top right if there are already some homes available.



- 3 The application will require the user to select the desired WIFI network to connect the monitor.



Android



iOS

Select (in case of Android) or enter (in case of iOS) the desired SSID (network name), enter the correct password to connect and click NEXT/ ACCEPT.

- 4 The application will require the user to open the connectivity menu on the monitor



- 4a Press the  MENU button to access the User Menu.

4b Correspondence between push buttons and navigation menu. - The white line at the bottom of the icon indicates that the function is currently in effect.

4c Select the connectivity menu on the monitor.

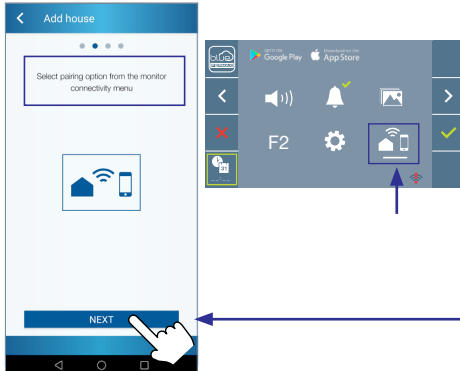
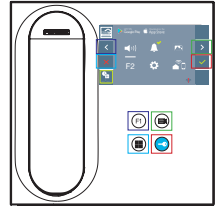

5 Once the connectivity menu is selected, confirm with to enter it.

Click NEXT, once ready.



6 The monitor will display a QR code on the screen. MAC is provided on screen in case the wifi router has a MAC filter.



7 The application will be ready to scan that code. Aim at the QR code on the monitor screen with the mobile aligning with the green square on the mobile screen.

8 The application and monitor will begin to synchronise with each other. The white WIFI LED on the monitor will start flashing.

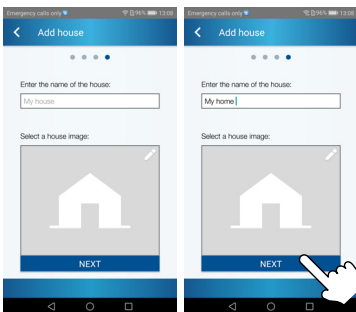
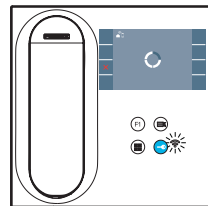
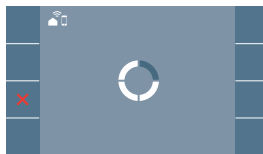

9 The screen for adding the home is displayed:
 - Name
 - Image (optional)
 Enter data and press NEXT.



- 11 If the WIFI network and the credentials provided are correct, the monitor will connect to the Internet and the process will be completed successfully.



- 12 The application will show the newly linked home as available and connected (green ✓ tick) and the monitor will show the result of the connection as successful. The white WIFI led will now stay on 

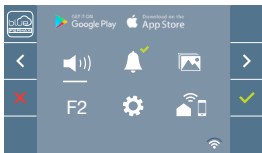
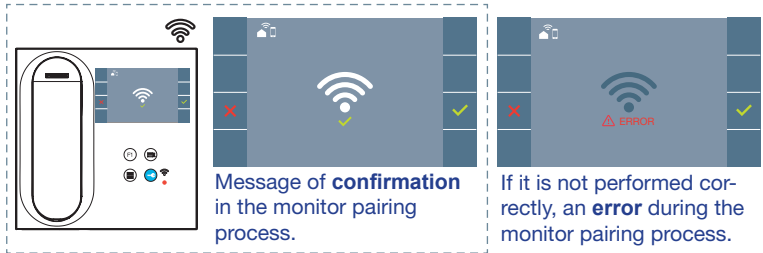

- 13 Once connected, if the user menu is opened again on the monitor, it will show the intensity of the WIFI signal on the bottom right.

Wifi signal strength icon displayed in the menu:



Between 0% and 20% or unpaired monitor.



Between 20% and 40%



Between 40% and 60%



Between 60% and 80%



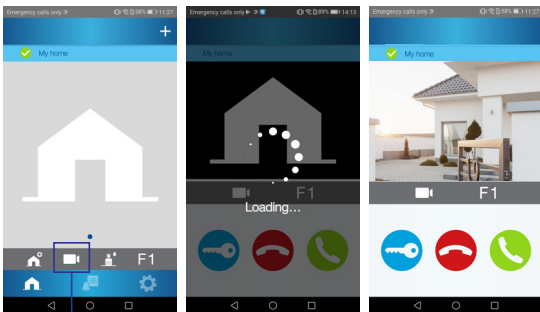

Between 80% and 100%



Auto-on

- 14 To test call forwarding, the user can perform an auto-on and ensure that it connects to the outdoor panel, (as long as it is not in use).

 User parameter settings:

 **USER RESET :**

A user reset returns the status of the monitor to unpaired (disconnected from the Internet).

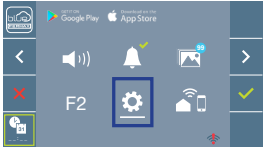
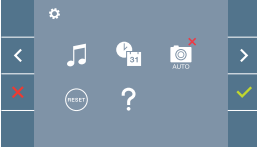

Note: This section goes through the most basic steps in quick commissioning. For more information, please download the **DUOX PLUS Blue mobile application manual**, code: **970156** at www.fermax.com.

2. USER PARAMETERS: Access User Parameters.

1  2  3 



2.1 Date and Time



2.2 Capture images

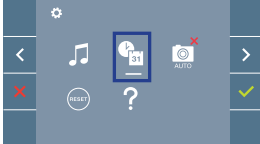
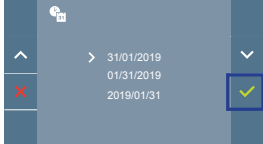

With  select the icon  and confirm with .





2.1 DATE AND TIME SETTINGS

The WIFI monitor automatically synchronizes the time with the time zone where it is installed whenever it is paired and connected to the Internet. In this case the date and time cannot be changed.

1  2  3 

With  select the icon  and confirm with .



With   select the date format. Once selected confirm with .

Select the date and hour with   and confirm . To browse the settings .

Date not set: 01/01/2019 (default). The icon  appears indicating that the date is not correct (default date). Upon losing power, it returns to the default date.

Note: If an image is captured with the date not yet set, the following icon appears .

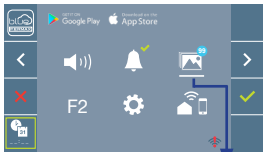
Notification icons for a date not set:

<p>User Menu Screen</p> 	<p>Communication screen</p> 	<p>Image viewer screen</p> 
---	---	---



 Image Viewer

2.2 ACTIVATION / DEACTIVATION OF VIDEO CAPTURE

The monitor can take an automatic picture within 3 seconds of receiving a call from an outdoor panel. According to the European Union legislation about data protection ((EU) 2016/679), the capture of images may be restricted. This feature is deactivated by default in all monitors, although can be activated at your own responsibility.

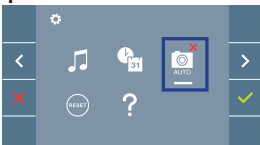
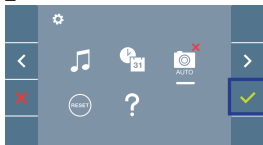
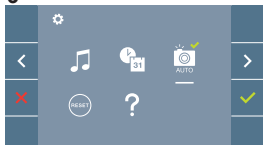
Furthermore, the legislation may force to place a sign next to door stations, indicating that monitors can capture images. You can download it at <https://www.fermax.com/intl/en/corporate/utilities.html>.

1  2  3 

With  select the icon  and confirm with .

Press  to activate/deactivate the function.

INSTALLATION

INSTALLATION DE LA PLATINE CÔTÉ RUE ET DU MONITEUR

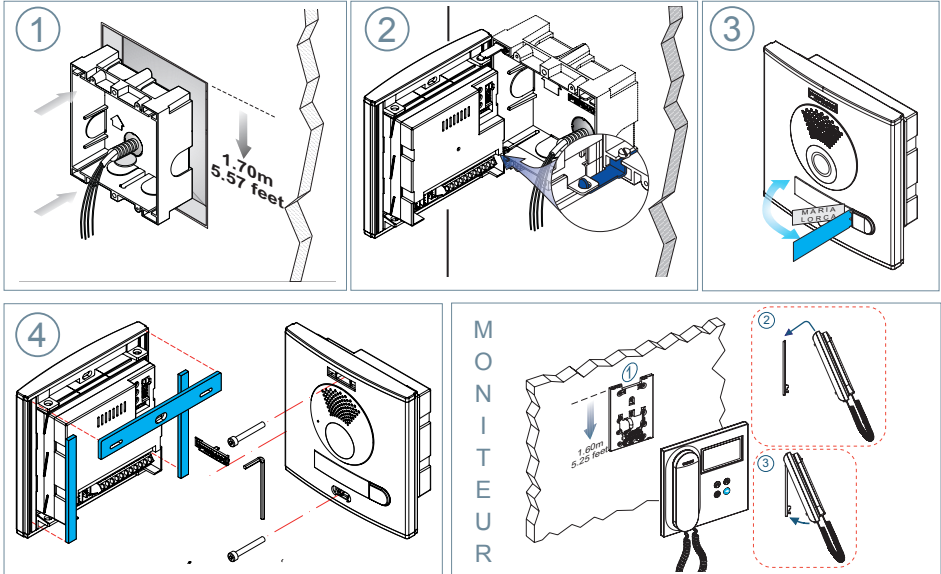



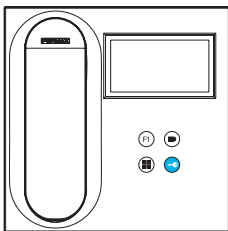

CONFIGURATION

MONITEUR VEO WIFI DUOX PLUS



Le moniteur fourni dans le kit EST DÉJÀ PROGRAMMÉ par défaut.
 Dans le cas des kits à 2 lignes, les deux moniteurs SONT PROGRAMMÉS.
BOUTONS DE COMMANDE

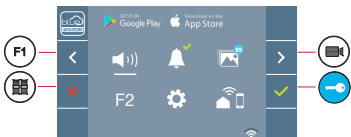

-  Menu numérique pour les réglages et configuration des paramètres internes (si le moniteur est programmé).
-  Lors d'une communication, appuyez dessus pour ouvrir la porte.
En veille, appel au concierge (s'il y a une conciergerie).
- F1**  Fonction auxiliaire (contactez votre installateur).
En veille, appuyez dessus. On a, à l'écran, la possibilité d'effectuer
-  l'auto-insertion avec différentes platines. En appuyant de manière séquentielle sur la platine 0, platine 1, platine générale (selon la disponibilité des platines).





Le moniteur VEO WIFI intègre un menu OSD qui est géré à l'aide des boutons-poussoirs du moniteur. Les icônes qui apparaissent à l'écran se manipulent à l'aide des boutons-poussoirs correspondants du moniteur.

La ligne blanche sous l'icône indique la fonction dans laquelle nous nous trouvons.
 Sélectionnez avec  /  l'icône désiré et validez à l'aide de .

RÉGLAGES

1. RÉGLAGES DU MONITEUR

RÉGLAGES VIDÉO

Si on a de l'image sur le moniteur en appuyant sur le bouton  (ou lors de la réception d'un appel sans ouvrir la communication), appuyez sur la touche  pour afficher les réglages vidéo.

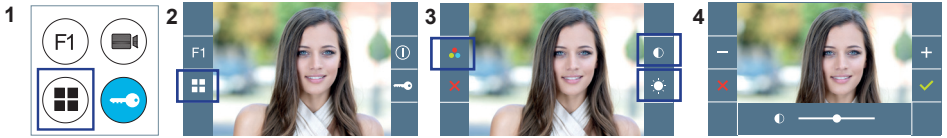

Sélectionnez l'option de réglage et augmentez ou diminuez à l'aide de **+** et **-**.

RÉGLAGES AUDIO

Pendant que le canal audio est ouvert, appuyez sur le bouton  et le menu pour ce réglage apparaîtra à l'écran.

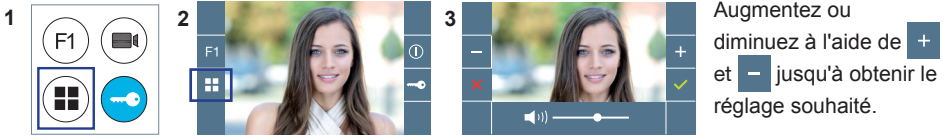

Augmentez ou diminuez à l'aide de **+** et **-** jusqu'à obtenir le réglage souhaité.

Remarque : temps maximal de communication : 90 secondes.

2. RÉGLAGES PLATINES

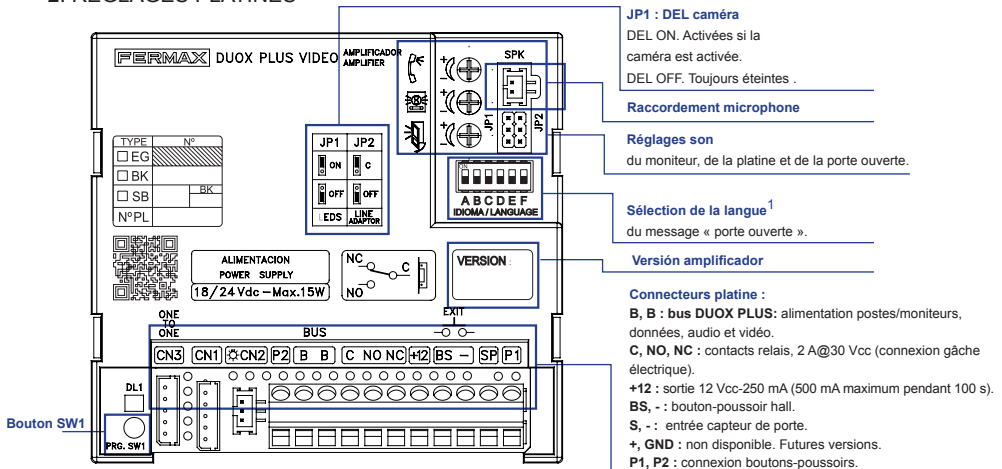

¹ Sélection de la langue du message vocal émis pour « porte ouverte ».

								31...62 Cloche			

3. CODIFICATION DES PLATINES*

Il faut, dès qu'il y a plus d'une platine, programmer le numéro des platines.

4. FOCALISATION DE LA CAMÉRA / TEMPS D'ACTIVATION DE LA GÂCHE ÉLECTRIQUE*

Afin de régler l'image de la caméra ou régler le temps d'activation de la gâche électrique.

* Voir Configuration avec assistance vocale sur les platines à boutons-poussoirs code 970048. Instructions fournies avec ce matériel.



CARACTÉRISTIQUES TECHNIQUES

CARACTÉRISTIQUES TECHNIQUES PLATINE

Alimentation	18-24 Vdc
Consommation en veille	2,86 W
Consommation avec son	6,30 (max) W
Puissance du son sens logement-rue	1 W
Puissance du son sens rue-logement	0,15 W
Température de service	[-25, +70 °C] / [-13, 158 °F]
Volume réglable dans les deux sens	

VALEURS PLATINE

Durée activation de la gâche	01...99 s. (par défaut : 03)
Durée activation bouton de sortie	00...99 s. (par défaut : 06) / (désactivé : 00)
Type de platine	sous-bâtiment/bâtiment/entrée générale. (par défaut : bâtiment)
Numéro de platine	0...9 (par défaut : 00)
Platine MASTER	

CARACTÉRISTIQUES TECHNIQUES MONITEUR (écran OSD TFT 4,3")

Alimentation	18-24 Vcc
Consommation en veille	1,3 W
Maximum Consommation	5,6 W
Température de service	[-5, +40 °C] / [23, 104 °F]



SCHÉMAS

TABLEAU SECTIONS - DISTANCES

Tableaux sections distances - INSTALLATION DE KITS VIDÉO

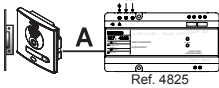
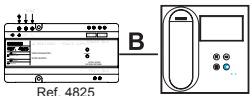
SECTION CÂBLE	 TERMINAUX pour logement sans alimentations supplémentaires	 Distance maximale (A) Alimentation / filtre jusqu'à la platine (platine-gâche électrique) (1)	 Distance maximale (B) Alimentation/filtre jusqu'au terminal le plus éloigné
2 x 1 mm ²	1	250	250
	2		200
	3		150
2 x 0,5 mm ²	1	200	200
	2		120
	3		70
2 x 0,2 mm ²	1	80	100
	2		50
	3		30

- (1) Pour une gâche de 12 Vcc avec une consommation max. de 250 mA, alimentation depuis l'amplificateur.

Remarque : pour un fonctionnement optimal, il est recommandé d'utiliser le même type de câble pour toute l'installation. Ne pas doubler les fils.

SCHEMA DE CÂBLAGE KIT 1 LIGNE

Exemple: Connexion gâche à courant continu.

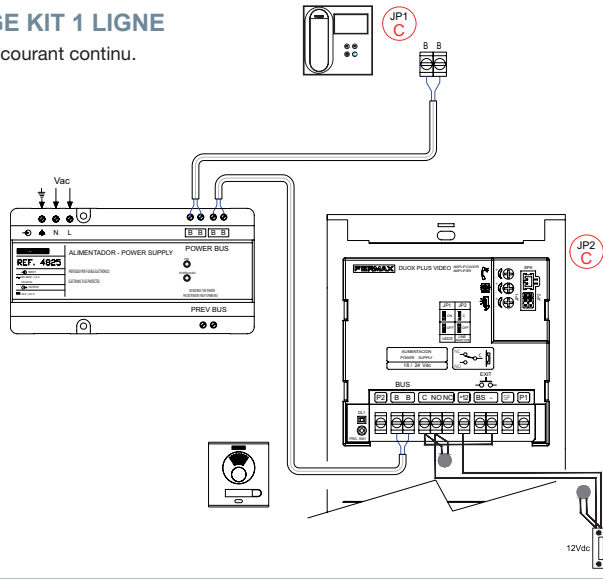

SCHEMA DE CÂBLAGE KIT 2 LIGNES

Exemple: Connexion gâche à courant alternatif.

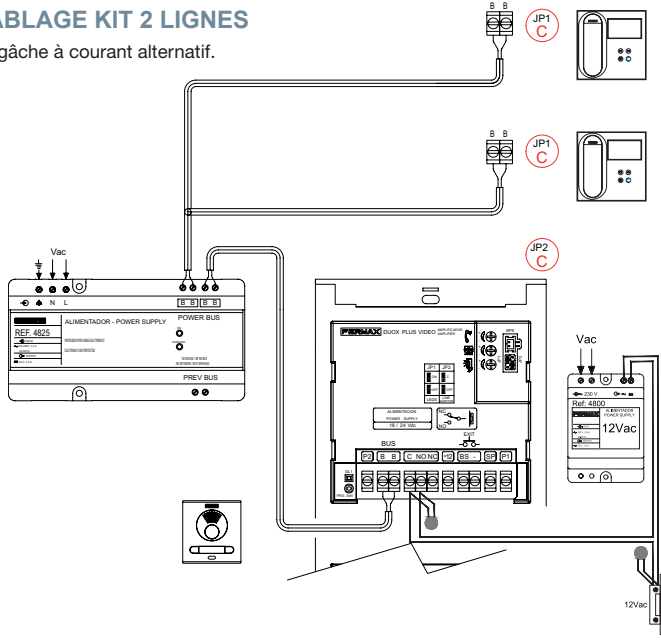

Remarque : ce document présente les concepts les plus basiques, qui permettent une mise en marche rapide. Pour plus de renseignements, téléchargez les manuels sur www.fermax.com

- Platines vidéo Cityline Duox Plus code 970050.
- Moniteur Duox Plus Veo WIFI code 970166.
- Manuel Technique Duox Plus 970122.

RÉGLAGES D'UTILISATEUR

1. APPAIRAGE. Transfert d'appel.

Le moniteur VEO WIFI DUOX PLUS permet d'accéder aux nouveaux services proposés par Fermax via son propre cloud, comme le transfert d'appel. Pour profiter de ce service, la première étape consiste à connecter le moniteur à Internet via le processus d'appairage.

Pour ce faire, vous devez utiliser l'application Blue disponible sur Google Play ou sur l'Apple Store.

RÉGLAGES DU MONITEUR. Processus d'appairage.

Une fois l'utilisateur enregistré et connecté, le processus d'appairage du moniteur grâce l'application Blue peut commencer.

Le moniteur DUOX PLUS ne prend en charge que le WIFI 2,4 GHz.

Étapes à suivre pour connecter le moniteur à Internet.



Android



iOS

1 Ouvrir l'application et se connecter.

2 Cliquer sur le bouton  au centre de l'écran (par défaut) ou en haut à droite s'il y a déjà des appartements disponibles.

3 L'application demandera à l'utilisateur de sélectionner le réseau WIFI souhaité pour connecter le moniteur.

Sélectionner (pour Android) ou entrer (pour iOS) le SSID (nom du réseau) souhaité, introduire correctement le mot de passe pour se connecter et cliquer sur SUIVANT/ACCEPTER.



4 L'application demandera à l'utilisateur d'ouvrir le menu de connectivité sur le moniteur



4a Appuyer sur le bouton MENU  pour accéder à l'écran Menu utilisateur.

4b Correspondance entre les boutons poussoirs et le menu de navigation.
La ligne blanche sous l'icône indique la fonction sélectionnée.

4c Sélectionner le menu de connectivité sur le moniteur.

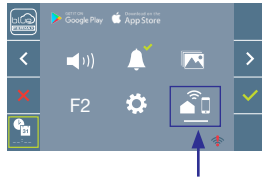
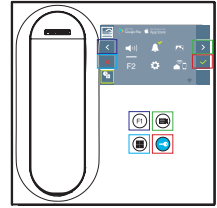

5 Une fois le menu de connectivité sélectionné, confirmer avec  pour y accéder.

Une fois prêt, cliquer sur SUIVANT.



6 Le moniteur affichera un code QR à l'écran.

Au cas où le routeur wifi a un filtre MAC, l'adresse MAC s'affiche à l'écran.



7 L'application sera prête à scanner ce code. Visez le code QR sur l'écran du moniteur avec le portable et alignez-le sur le carré vert de l'écran du téléphone.

8 L'application et le moniteur commencent à se synchroniser. La led blanche WIFI du moniteur commence à clignoter.

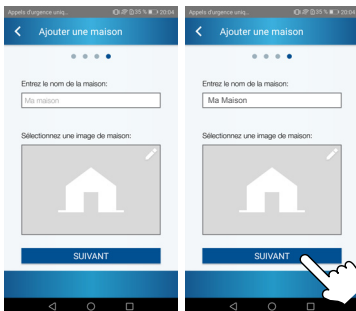
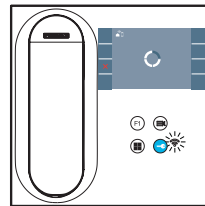
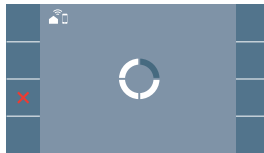

9 L'écran d'ajout d'appartement s'affiche :

- Nom
- Image (facultatif)

Entrer les données et appuyez sur SUIVANT.



- 11 Si le réseau WIFI et les identifiants fournis sont corrects, le moniteur se connectera à Internet et le processus sera terminé avec succès.



- 12 L'application affichera le nouvel appartement associé comme disponible et connecté (coche verte ✓) et le moniteur affichera le résultat de la connexion comme réussi. La led blanche WIFI blanc reste allumée. 📶

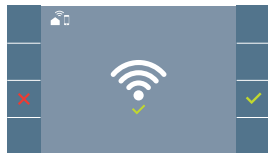
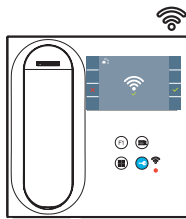

Message de **confirmation** dans le processus d'appariement des moniteurs.

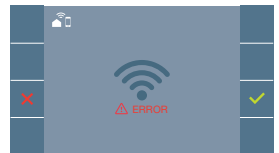

S'il ne s'est pas exécuté correctement, message d'**erreur** dans le processus d'appariement du moniteur.

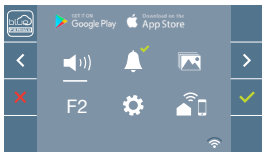

- 13 Une fois connecté, l'intensité du signal WIFI s'affiche en bas à droite du menu de l'utilisateur s'il est ouvert à nouveau.

Niveaux d'intensité de l'icône du signal wifi affichée dans le menu :



Entre 0 % et 20 %
Ou moniteur non appairé.



Entre 20% et 40%



Entre 40% et 60%



Entre 60% et 80%



Entre 80% et 100%



Auto-allumage

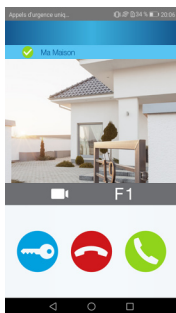
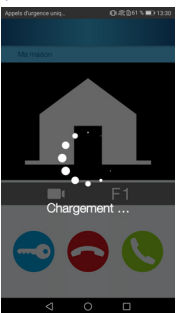

- 14 Pour tester le transfert d'appel, l'utilisateur peut effectuer un auto-allumage et voir qu'il se connecte à la platine extérieure (tant qu'elle n'est pas en cours d'utilisation).

⚙️ Réglages des paramètres d'utilisateur:
 🔄 RÉINITIALISATION DE L'UTILISATEUR:
 Une réinitialisation de l'utilisateur rétablit le statut du moniteur à non-appairé (déconnecté d'Internet).

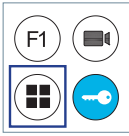
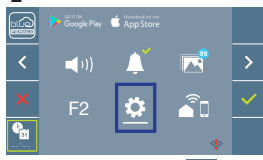
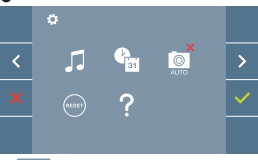

Note : Ce chapitre présente les notions de base pour une mise en service rapide, pour plus d'informations, téléchargez le manuel **DUOX PLUS Blue Application pour la morue mobile code. 970156** à l'adresse www.fermax.com.

2. PARAMÈTRES UTILISATEUR : Accéder à l'écran Paramètres d'utilisateur.

1  2  3 

2.1 Réglages Date et heure



2.2 Capture d'images



Sélectionnez avec > l'icône  et validez avec .

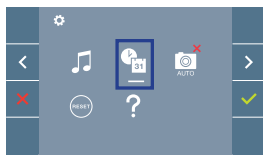
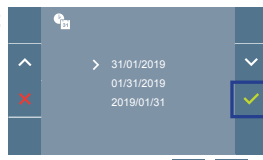
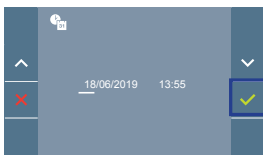

2.1 RÉGLAGES DATE ET HEURE

Lorsqu'il est appairé et connecté à Internet, le moniteur WIFI synchronise automatiquement l'heure avec le fuseau horaire qui correspond à l'endroit où il est installé. Dans ce cas, la date et l'heure ne peuvent pas être modifiées.

1  2  3 

Sélectionnez avec > l'icône  et validez avec .

Sélectionnez avec   le format de la date. Une fois sélectionné, validez avec .

Sélectionnez la date et l'heure avec   et validez avec . Pour naviguer parmi les réglages >.

Date non programmée : 01/01/2019 (par défaut). L'icône  s'affiche en indiquant que la date n'est pas correcte (date par défaut). En cas de coupure, la date revient à celle par défaut.

Remarque : si une image est capturée alors que la date n'est pas programmée, l'icône  s'affichera. Icônes de notification de date non programmée :

Écran Menu utilisateur

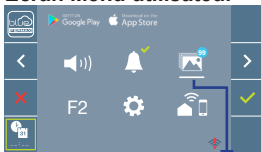

Visualisation des images

Écran Communication



Écran Visualisation des images



2.2 ACTIVATION / DÉSACTIVATION CAPTURE DES IMAGES

L'écran peut prendre une photo automatique 3 secondes après avoir reçu un appel de la platine de rue. Conformément à la loi de protection des données (EU 2016/679) de l'Union Européenne, l'utilisation de la capture d'images du vidéophone peut être restreinte. Cette fonction est désactivée par défaut. Elle peut être activée depuis le moniteur sous votre responsabilité.

De la même façon, il peut être obligatoire de placer à côté de la platine de rue un pancarte indiquant que le moniteur peut capturer des images. Vous pouvez télécharger cette affiche sur le site suivant : <https://www.fermax.com/intl/fr/corporate/utilites.html>.

1  2  3 

Sélectionnez avec > l'icône  et validez avec .

Appuyez sur  pour activer/désactiver la fonction.

✂ INSTALLATION

TÜRSTATION- UND MONITORINSTALLATION

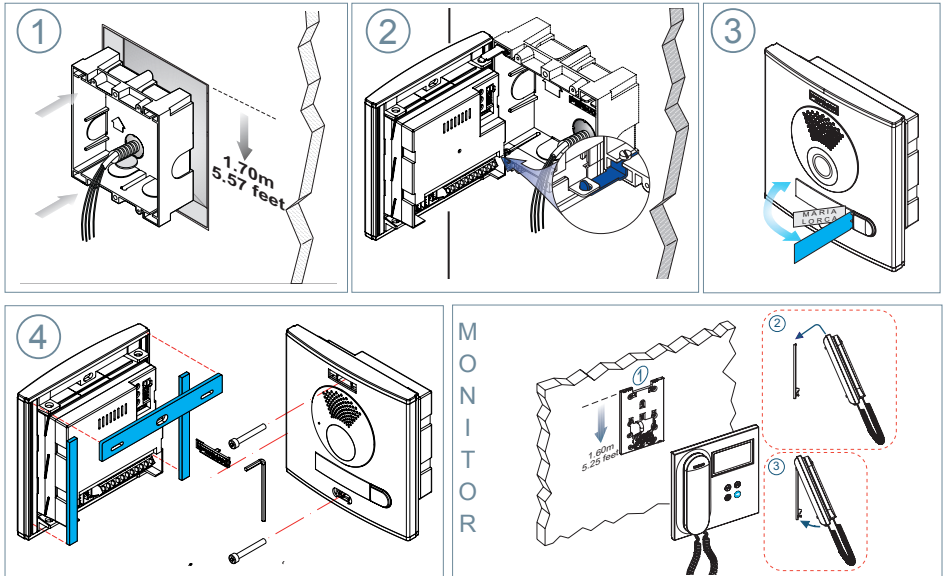





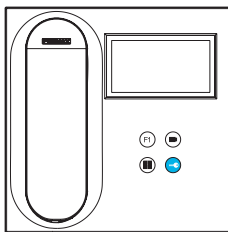

📺 KONFIGURATION

DUOX PLUS VEO WIFI MONITOR

Der im Set mitgelieferte Monitor ist **BEREITS WERKSSEITIG** programmiert.
Beim Set mit 2 Linien sind die Monitore auch **VORPROGRAMMIERT**.

BEDIENTASTEN



-  Digitales Menü zur Vornahme der Einstellung und Konfiguration der internen Parameter. (Falls der Monitor programmiert ist.)
-  Im Sprechmodus drücken, um die Tür zu öffnen.
-  Im Bereitschaftsmodus den Portier anrufen (falls es eine Portierzentrale gibt).
- F1**  Zusatzfunktion (fragen Sie Ihren Installateur).
Im Bereitschaftsmodus drücken, um auf dem Bildschirm die
-  Eigenstartoption über verschiedene Türstationen einzublenden. Dazu abwechselnd Türstation 0, Türstation 1 und Haupttürstation (gemäß Verfügbarkeit der Türstationen) drücken.

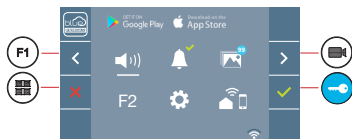

Der Monitor WIFI VEO enthält ein OSD-Menü, das über die Monitortasten bedient werden kann. Die auf dem Bildschirm angezeigten Symbole werden mit den entsprechenden Monitortasten bedient.



Die weiße Linie unter dem Symbol zeigt die aktuelle Funktion an.

Mittels das Symbol  /  wählen gewünschte icon und mit  bestätigen.

EINSTELLUNGEN

1. MONITOREINSTELLUNGEN

VIDEOEINSTELLUNGEN

Wenn ein Bild auf dem Monitor eingeblendet wird (oder bei einem eingehenden Anruf ohne die Kommunikation zu starten) zuerst die Taste  und anschließend die Taste  drücken, um die Videoeinstellungen einzublenden.



AUDIOEINSTELLUNGEN

Während der Audiokanal geöffnet ist, die Taste  drücken, um die Menüfunktionen dieser Einstellung aufzurufen.

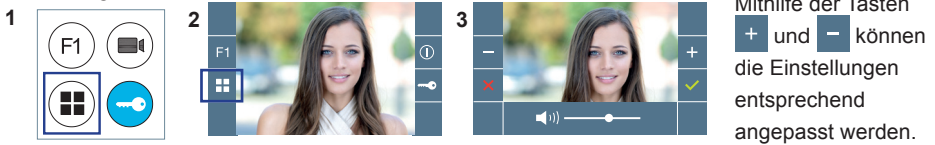

Hinweis: Maximale Gesprächsdauer: 90 Sekunden.

2. TÜRSTATIONEINSTELLUNGEN

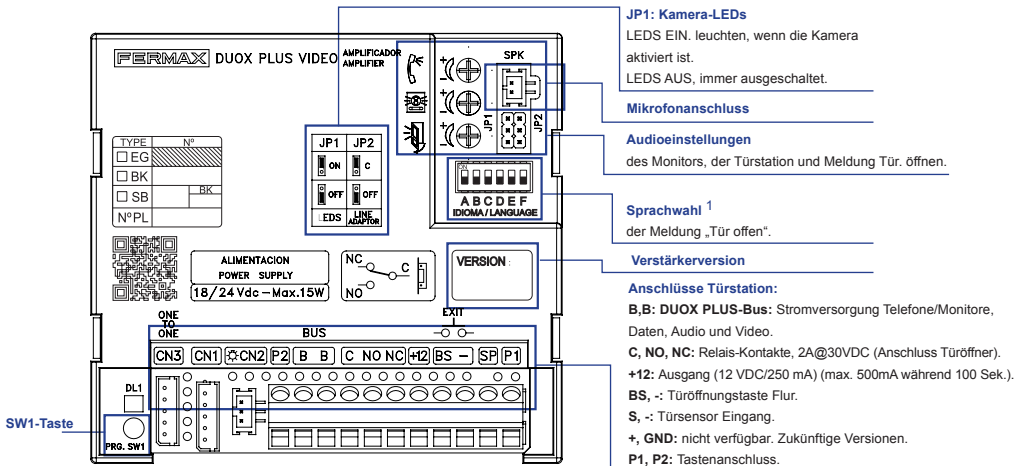

¹ Sprachwahl der Meldung „Tür offen“

0 Spanisch	1 Englisch	2 Französisch	3 Niederländisch/Französisch	4 Deutsch	5 Katalanisch	6 Valencianisch	7 Balearisch	8 Portugiesisch	9 Baskisch	10 Galizisch	11 Griechisch
12 Polnisch	13 Tschechisch	14 Slowakisch	15 Türkisch	16 Chinesisch	17 Persisch/Farsi	18 Arabisch	19 Norwegisch	20 Finnisch	21 Schwedisch	22 Dänisch	23 Isländisch
								31...62 Glocke			
24 Russisch	25 Italienisch	26 Hindi	27 Ungarisch	28 Hebräisch	29 Kroatisch	30 Französisch (LANGUE)	31 campana			62 Glocke	63 DEAKTIVIERT

3. TÜRSTATIONEN KONFIGURIEREN*

Falls mehr als eine Türstation vorhanden ist, müssen die Türstationen programmiert werden, damit sie Nummern aufweisen.

4. KAMERAFOKUS / AKTIVIERUNGSZEIT DES TÜRÖFFNERS*

Um das Kamerabild oder die Aktivierungszeit des Türöffners einzustellen.

* Siehe sprachgeführte Konfiguration bei Türstationen mit Tastenmodulen, Kode 970048. Die Anleitung ist in der Geräteverpackung enthalten.



TECHNISCHE EIGENSCHAFTEN

TECHNISCHE EIGENSCHAFTEN TÜRSTATION

Stromversorgung	18-24 Vdc
Stromverbrauch im Bereitschaftsmodus	2,86 W
Stromverbrauch im Sprechmodus	6,30 (max) W
Audialeistung Wohnung ->Türstation	1 W
Audialeistung Türstation > Wohnung	0,15 W
Betriebstemperatur	[- 25 °C , + 70 °C] / [- 13 °F, 158 °F]
Regulierbare Lautstärke in beiden Richtungen	

WERTE TÜRSTATION

Aktivierungszeit Türöffner	01...99 Sek. (standardmäßig: 03)
Aktivierungszeit Türöffnungstaste:	00...99 Sek. (standardmäßig: 06) / (deaktiviert: 00)
Türstationtyp	Nebenblock/Block/Haupteingang, (standardmäßig: Block)
Türstationnummer	0...9 (standardmäßig: 00)

MASTER-Türstation

TECHNISCHE EIGENSCHAFTEN MONITOR (4;3" Flachbildschirm mit Bildschirmanzeige (OSD))

Stromversorgung	18-24 Vdc
Stromverbrauch im Bereitschaftsmodus	1,3 W
Stromverbrauch maximal	5,6 W
Betriebstemperatur	[- 5 °C , + 40 °C] / [23 °F, 104 °F]



SCHEMATA

QUERSCHNITT-UNDBABSTANDSTABELLE

Querschnitt- und Abstandstabellen - INSTALLATION VON VIDEO-SETS

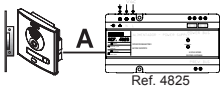
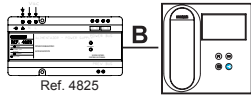
KABEL QUERSCHNITT			
	SPRECH-STELLEN pro Wohnung ohne zusätzliche Netzgeräte	Maximaldistanz (A) Netzgerät/ Filter bis Türstation (Türstation-Türöffner) (i)	Maximaldistanz (B) Netzgerät/ Filter bis zur am weitesten entfernte Sprechstelle
2 x 1 mm ²	1	250	250
	2		200
	3		150
2 x 0,5 mm ²	1	200	200
	2		120
	3		70
2 x 0,2 mm ²	1	80	100
	2		50
	3		30

(i) Für 12-VDC-Türöffner und maximalem Stromverbrauch von 250 mA, mit Stromversorgung über den Verstärker.

Hinweis: Für einen optimalen Betrieb empfehlen wir denselben Kabeltyp für die gesamte Anlage zu verwenden. Drähte nicht verdoppeln.

VERKABELUNGSSCHEMA 1-LINIEN-SET

Beispiel: Anschluss Türöffner mit Gleichstrom

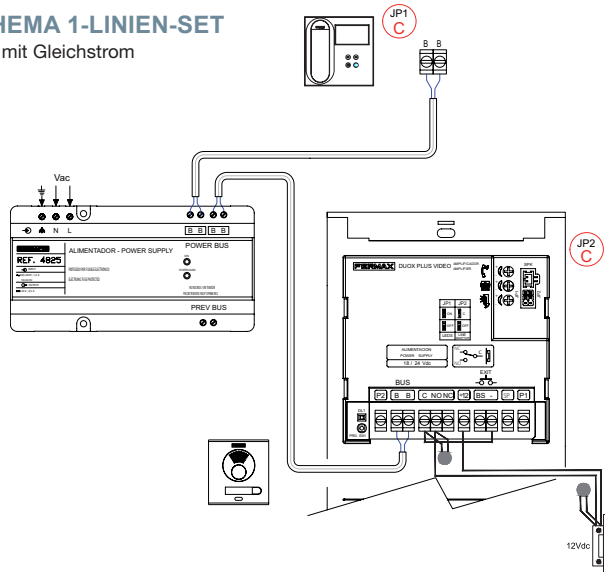

VERKABELUNGSSCHEMA, 2-LINIEN-SET

Beispiel: Anschluss Türöffner mit Wechselstrom.

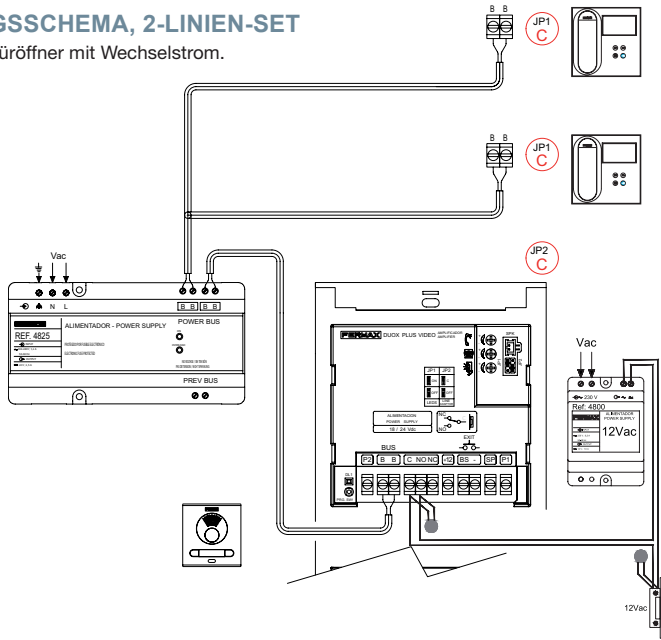

Hinweis: Dieses Dokument veranschaulicht die grundlegenden Konzepte für eine schnelle Inbetriebnahme der Anlage.

Weitere Information können Sie den Handbüchern auf www.fermax.com entnehmen.

- Türstationen Cityline Video Duox Plus, Kode 970050.

- Duox Plus Veo WIFI Monitor, Kode 970166.

- Duox Plus Technisches Handbuch, Kode 970122.

BENUTZER-EINSTELLUNGEN

1. PAIRING. Rufweiterleitung.

Der VEO WIFI DUOX PLUS Monitor ermöglicht den Zugriff auf neue von Fermax angebotene Services über eine eigene Cloud, wie z.B. die Rufweiterleitung. Um diesen Service in Anspruch nehmen zu können, ist der erste Schritt, den Monitor über den sogenannten Pairing-Prozess mit dem Internet zu verbinden. Hierzu ist es erforderlich, die Blue App zu verwenden, die im Google Play oder Apple Store verfügbar ist.

Monitor-Einstellungen. Pairing-Prozess.

Mit Hilfe der Blue-App und nachdem sich der Benutzer registriert und eingeloggt hat, können wir mit dem Pairing des Monitors beginnen.

Der DUOX PLUS-Monitor ist nur mit WLAN-2,4Ghz kompatibel.

Vorgehensweise zur Verbindung des Monitors mit dem Internet.



Android

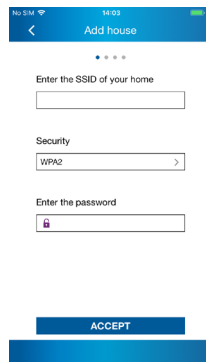

iOS

1 Starten Sie die Anwendung und melden Sie sich an.

2 Klicken Sie auf die Schaltfläche  in der Mitte des Standardbildschirms oder oben rechts, wenn bereits einige Wohnungen verfügbar waren.

3 Die Anwendung erfordert, dass der Benutzer das gewünschte WLAN-Netzwerk für den Anschluss des Monitors auswählt.

Wählen Sie (bei Android) oder geben Sie (bei iOS) die gewünschte SSID (Netzwerkname) ein, geben Sie das richtige Passwort für die Verbindung ein und klicken Sie auf NEXT/ ACCEPT.

4 Die Anwendung erfordert, dass der Benutzer das Konfigurationsmenü für die Verbindung auf dem Monitor aufruft: 

4a Durch Drücken der MENÜ-Taste  gelangen Sie zum Benutzermenü-Bildschirm.

4b Zuordnung zwischen Drucktasten und Navigationsmenü. Die weiße Linie unter dem Symbol zeigt die Funktion an, in der wir uns befinden.

4c Wählen Sie das Einstellungsmenü für die Verbindung auf dem Monitor.

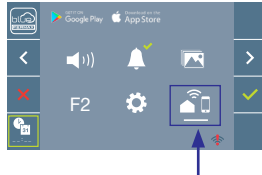
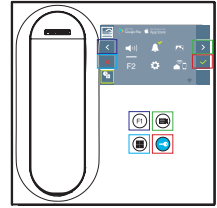

5 Sobald das Verbindungs-menü ausgewählt ist, bestätigen Sie mit , um es zu öffnen.

Klicken Sie auf NÄCHSTE, sobald Sie fertig sind.



6 Der Monitor zeigt einen QR-Code auf dem Bildschirm an. MAC wird auf dem Bildschirm angezeigt, falls der WLAN-Router über einen MAC-Filter verfügt.

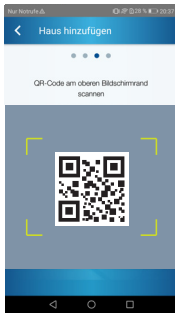

7 Die Anwendung ist bereit, diesen Code zu scannen. Zeigen Sie mit dem Mobiltelefon auf den QR-Code auf dem Bildschirm, wobei das Mobiltelefon mit dem grünen Quadrat auf dem Bildschirm des Mobiltelefons ausgerichtet ist.

8 Die Applikation und der Monitor beginnen sich miteinander zu synchronisieren. Die weiße WLAN-LED am Monitor beginnt zu blinken.

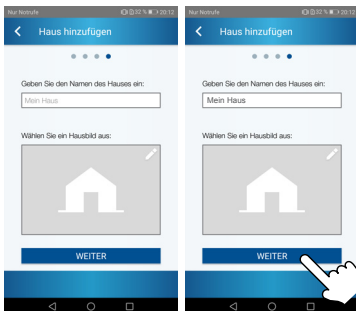
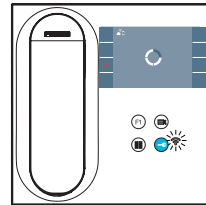
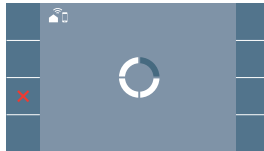

9 Der Bildschirm zum Hinzufügen der Wohnung wird angezeigt:

- Name
- Bild (optional)

Geben Sie die Daten ein und drücken Sie NEXT.



- 11 Wenn das WLAN-Netzwerk und die angegebenen Zugangsdaten korrekt sind, verbindet sich der Monitor mit dem Internet und der Prozess wird erfolgreich abgeschlossen.



- 12 Die Anwendung zeigt die neue verbundene Wohnung als verfügbar und verbunden an (grünes Häkchen ✓) und der Monitor zeigt das Ergebnis der Verbindung als erfolgreich an. Die weiße WLAN-LED leuchtet nun weiter. 

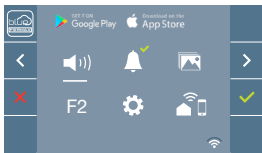
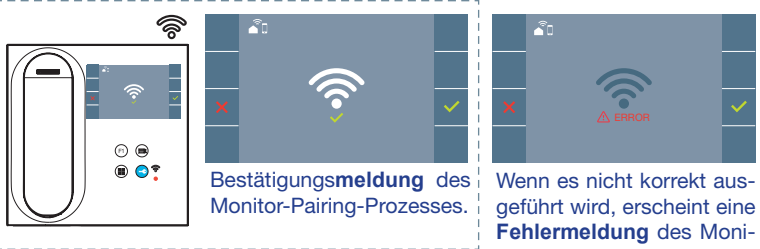

- 13 Sobald die Verbindung hergestellt ist, wird bei erneutem Aufrufen des Benutzermenüs unten rechts auf dem Monitor die Stärke des WLAN-Signals angezeigt.

Intensitätsstufen des im Menü angezeigten WLAN-Signalsymbols:



Zwischen 0% und 20% oder nicht gekoppelter Monitor.



Zwischen 20% und 40%



Zwischen 40% und 60%.



Zwischen 60% und 80%



Zwischen 80% und 100%.

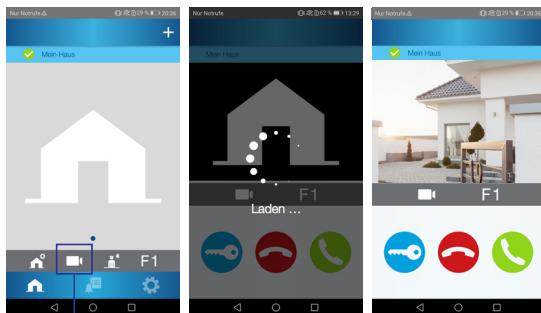

Eigenstart

- 14 Um die Rufweiterleitung zu testen, kann der Benutzer eine automatische Einschaltung durchführen und nachvollziehen, dass er sich mit der Türstation im Außenbereich verbindet (sofern sie nicht in Gebrauch ist).

 Benutzereinstellungen:

 BENUTZER-RESET:

Ein Benutzer Reset setzt den Status des Monitors auf nicht gekoppelt (vom Internet getrennt) zurück.

Hinweis: In diesem Kapitel werden die wichtigsten Grundlagen für eine schnelle Inbetriebnahme beschrieben. Weitere Informationen finden Sie im DUOX PLUS Blue Application Handbuch für mobile Anwendungen. Code 970156 unter www.fermax.com.

2. PARAMETEREINSTELLUNGEN DES BENUTZERS: Aufrufen des Menüs Benutzerparameter.

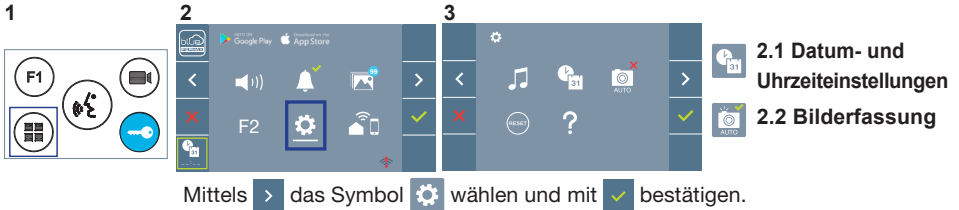



2.1 Datum- und Uhrzeiteinstellungen

2.2 Bildaufnahme

2.1 DATUM - UND UHRZEITEINSTELLUNGEN

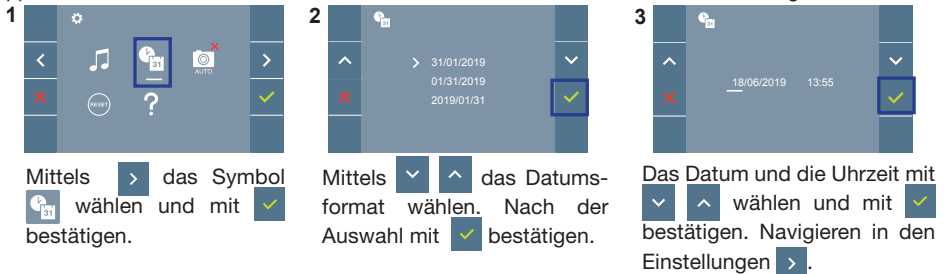
Der WIFI-Monitor synchronisiert die Zeit automatisch mit der Zeitzone, in der er installiert ist, wenn er gekoppelt und mit dem Internet verbunden ist. In diesem Fall können Datum und Uhrzeit nicht geändert werden.



Daten ohne Programmierung: 01/01/2019 (standardmäßig). Das Symbol  wird eingeblendet und zeigt an, dass das Datum nicht richtig ist (standardmäßiges Datum). Bei Unterbruch der Stromversorgung wird das standardmäßige Datum wiederhergestellt.

Hinweis: Falls ein Bild aufgenommen wird, ohne dass ein Datum einprogrammiert ist, wird das Symbol  angezeigt.

Symbole bei Datum ohne Programmierung:

Bildschirm Benutzermenü

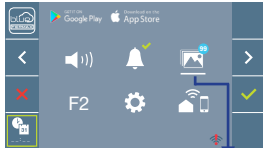

Visualisierung der Bilder

Kommunikationsbildschirm



Bildschirm Bildanzeige

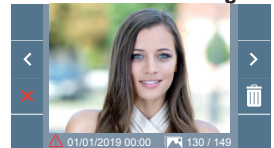

2.2 AKTIVIERUNG / DEAKTIVIERUNG DER BILDAUFNAHME

Der Monitor kann 3 Sekunden nach Anrufergang von einer Türstation automatisch ein Bild aufnehmen. Aufgrund der Datenschutzverordnung (EU 2016/679) der Europäischen Union kann die Aufnahme von Bildern eingeschränkt werden. Im Auslieferungszustand ist diese Funktion deaktiviert, kann aber auf eigene Verantwortung aktiviert werden.

Ebenfalls könnte diese Verordnung zwingend vorschreiben, dass ein Warnschild neben der Türstation zu platzieren ist, welches auf die Bildspeicherfunktion des Monitors hinweist. Ein solches Musterschild können Sie sich von <https://www.fermax.com/intl/de/pro/online-support.html> downloaden.

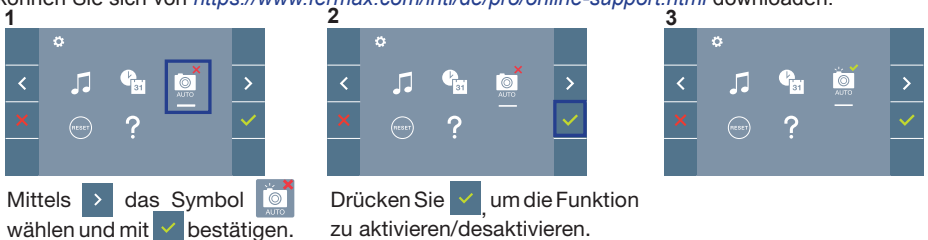

INSTALAÇÃO

INSTALAÇÃO DA BOTONEIRA NA RUA E DO MONITOR

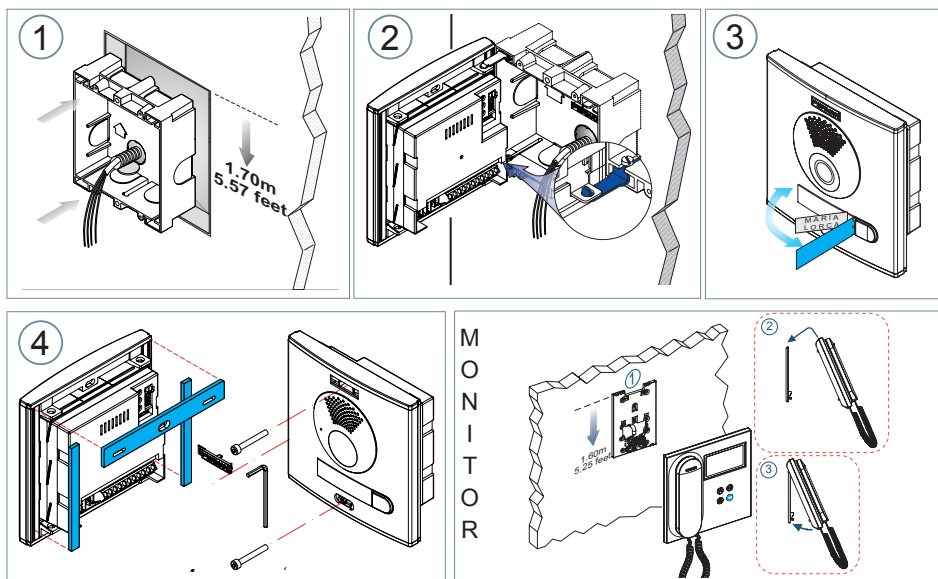

CONFIGURAÇÃO



MONITOR VEO WIFI DUOX PLUS

O monitor fornecido no kit JÁ VEM PROGRAMADO de fábrica.

No caso do kit de 2 linhas, ambos os monitores já VÊM PROGRAMADOS.

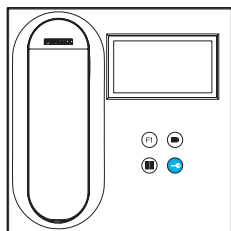
BOTÕES DE CONTROLO



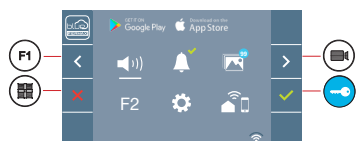

-  Menu digital para ajustes e configuração de parâmetros internos. (Se o monitor está programado).
-  Em conversação, premir para abrir a porta.
Em repouso, chamada ao porteiro (se existir portaria).
-  Função auxiliar (consulte o seu instalador).
Em repouso, ao premir, visualiza-se no ecrã a possibilidade de efetuar a ligação automática com diferentes botoneiras. Premindo sequencialmente Botoneira 0, Botoneira 1, Botoneira Geral (conforme a disponibilidade de botoneiras).



O monitor VEO WIFI integra um menu OSD que é gerido através dos botões do monitor. Os ícones visualizados no ecrã são comandados por meio dos botões correspondentes localizados no monitor.

A linha branca debaixo do ícone indica a função em que nos encontramos.

Selecionar com  /  o ícone desejado e confirmar com .

AJUSTES

1. AJUSTES DO MONITOR

AJUSTES DE VÍDEO

Tendo imagem no monitor ao premir o botão , (ou ao receber uma chamada sem iniciar a comunicação) pressionar a tecla  para mostrar os ajustes de vídeo.

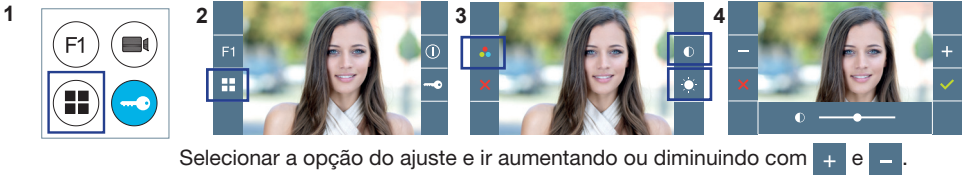

AJUSTES DE ÁUDIO

Enquanto o canal de áudio estiver aberto, premindo o botão , aparecerá no ecrã o menu para tal ajuste.

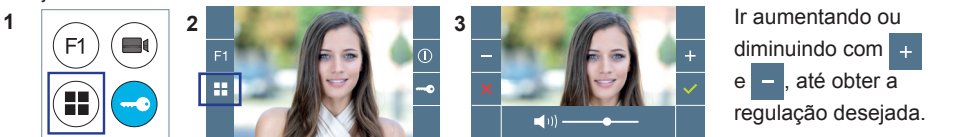

Nota: Tempo máximo de conversação: 90 segundos.

2. AJUSTES DAS BOTONEIRAS

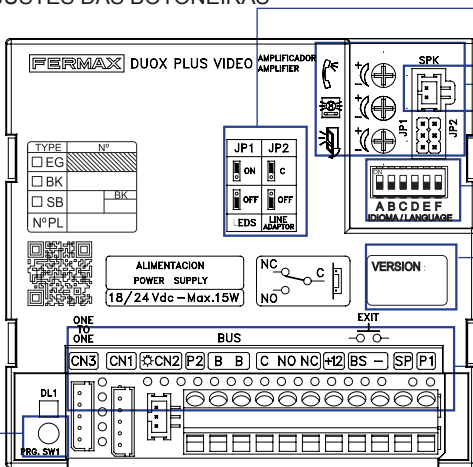

- JP1: LED da câmara**
LED ON acesos quando a câmara está ativada.
LED OFF, sempre apagados.
- Ligação do microfone**
- Ajustes de áudio**
do Monitor, da botoneira e porta aberta.
- Seleção da língua¹**
da mensagem "porta aberta".
- Versão do amplificador**
- Conectores de Botoneira:**
- B, B:** Bus DUOX PLUS: alimentação de telefones/monitores, dados, áudio e vídeo.
- C, NO, NC:** contactos de relé, 2A@30VDC (ligação do trinco).
- +12:** saída de 12 VDC-250 mA (máximo 500 mA durante 100 seg.)
- BS, -:** botão do hall de entrada.
- S, -:** entrada para sensor de porta.
- +, GND:** não disponível. Futuras versões.
- P1, P2:** ligação de botões.

¹ Seleção da língua da mensagem "Porta aberta"

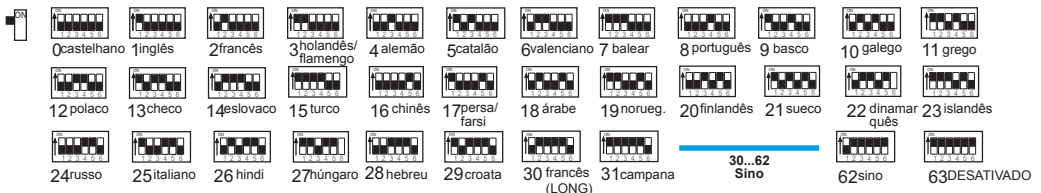

3. CODIFICAR BOTONEIRAS*

Sempre que exista mais que uma botoneira, será necessário programar o número de botoneiras.

4. FOCAGEM DA CÂMARA / TEMPO DE ATIVAÇÃO DO TRINCO*

Para ajustar a imagem da câmara ou regular o tempo de ativação do trinco.

* Ver Configuração assistida por voz em placas de interruptores cód. 970048. Instrução incluída neste equipamento.



CARACTERÍSTICAS TÉCNICAS

CARACTERÍSTICAS TÉCNICAS DA BOTONEIRA

Alimentação	18-24 Vdc
Consumo em repouso	2,86 W
Consumo de áudio ativo	6,30 (max) W
Potência de áudio no sentido habitação-rua	1 W
Potência de áudio no sentido rua-habitação	0,15 W
Temperatura de funcionamento	[-25° , +70°C] / [-13°, 158°F]
Volume regulável em ambos os sentidos	

VALORES DA BOTONEIRA

Tempo de ativação do trinco	01...99 seg. (por predefinição: 03)
Tempo de ativação do botão de saída	00...99 seg. (por predefinição: 06) / (desativado: 00)
Tipo de botoneira	subbloco/bloco/entrada geral. (por predefinição: bloco)
Número de botoneira	0...9 (por predefinição: 00)
Botoneira MASTER	

CARACTERÍSTICAS TÉCNICAS DO MONITOR (Ecrã OSD TFT 4,3")

Alimentação	18-24 Vdc
Consumo em repouso	1,3 W
Consumo maximo	5,6 W
Temperatura de funcionamento	[-5 °, +40 °C] / [23 °, 104 °F]



ESQUEMAS

TABELA DE SECÇÕES - DISTÂNCIAS

Tabelas de secções e distâncias - INSTALAÇÃO DE KITS DE VÍDEO			
SECÇÃO CABO	TERMINAIS por habitação sem fontes adicionais	Distância máxima (A) Fonte/Filtro até à Botoneira (Botoneira-Trinco) (i)	Distância máxima (B) Fonte/Filtro até ao Terminal mais afastado
2 x 1 mm ²	1	250	250
	2		200
	3		150
2 x 0,5 mm ²	1	200	200
	2		120
	3		70
2 x 0,2 mm ²	1	80	100
	2		50
	3		30

- (i) Para trincos de 12 VDC e consumo máx. de 250 mA, alimentador a partir do amplificador.

Nota: Para um funcionamento ideal, recomenda-se a utilização do mesmo tipo de cabo em toda a instalação. Não duplicar fios.

ESQUEMA DE CABLAGEM DO KIT DE 1 LINHA

Exemplo: Conexão trinco de corrente contínua.

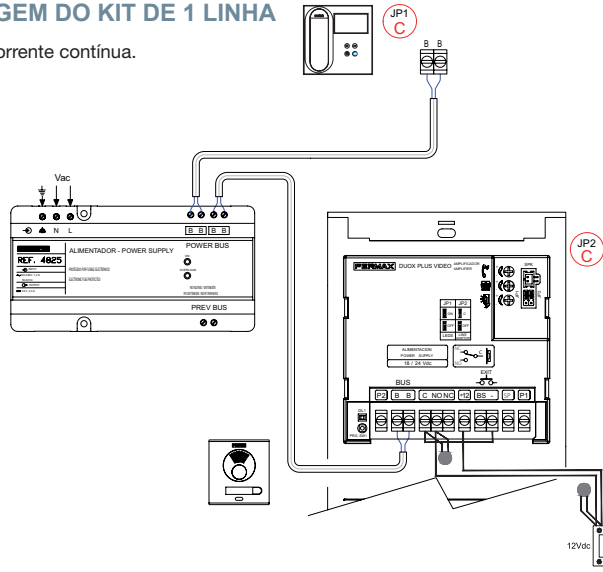

ESQUEMA DE CABLAGEM DO KIT DE 2 LINHAS

Exemplo: Conexão trinco de corrente alternada.

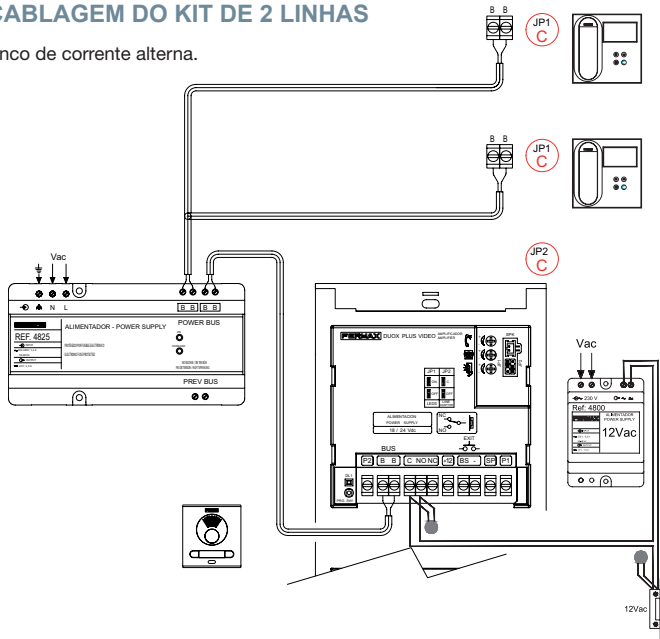

Nota: Este documento apresenta os conceitos mais básicos para a rápida colocação em funcionamento; para mais informação, fazer o download dos manuais em www.fermax.com

- Botoneiras Cityline Vídeo Duox Plus cód. 970050.

- Monitor Duox Plus Veo WiFi cód. 970166.

- Livro Técnico Duox Plus cód. 970122.

AJUSTES DE USUÁRIO

1. EMPARELHAMENTO. Reencaminhamento de chamadas.

O monitor VEO WIFI DUOX PLUS permite aceder aos novos serviços oferecidos pela Fermax através da sua própria nuvem, como o reencaminhamento de chamadas. Para usufruir deste serviço o primeiro passo é conectar o monitor à Internet através do processo denominado emparelhamento.

Para tal, é necessário usar a aplicação Blue disponível no Google Play ou na Apple Store.

Ajustes do monitor. Processo de emparelhamento.

Com a ajuda da aplicação Blue e após o registo e início de sessão o usuário poderá iniciar o processo de emparelhamento do monitor.

O monitor DUOX PLUS apenas é compatível com WIFI 2.4GHz.

Passos para conectar o monitor à Internet.

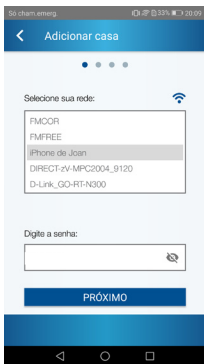

Android

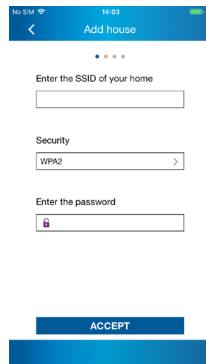

iOS

1 Abrir a aplicação e iniciar sessão.

2 Clicar no botão  situado no centro do ecrã predefinido ou no canto superior direito se já existirem algumas vivendas disponíveis.

3 A aplicação solicita ao usuário a seleção da rede WIFI desejada para conectar o monitor.

Selecionar (no caso do Android) ou inserir (no caso do iOS) o SSID desejado (nome da rede), digitar a senha correta para conectar e clicar em NEXT/ ACCEPT.

4 A aplicação solicita ao usuário a abertura do menu de conectividade no monitor



4a Pressionar o botão MENU  para aceder ao ecrã Menu do Usuário.

4b Correspondência entre os botões e o menu de navegação. A linha branca situada abaixo do ícone indica a função em que estamos.

4c Seleccione o menu de conectividade no monitor.

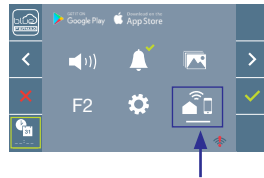
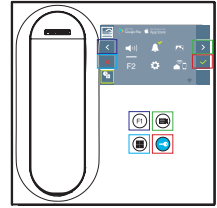

5 Depois de seleccionar o menu de conectividade, confirmar com para aceder ao mesmo.

Clicar em SEGUINTE, quando estiver pronto.



6 O monitor mostrará um código QR no ecrã.

O MAC é fornecido no ecrã para os casos em que o router wifi tenha filtro MAC.



7 A aplicação estará pronta para digitalizar o código em questão. Apontar para o QR no ecrã do monitor com o telemóvel alinhado com o quadrado verde no ecrã do telemóvel.

8 A aplicação e o monitor começarão o processo de sincronização. O LED WIFI branco no monitor começará a piscar.

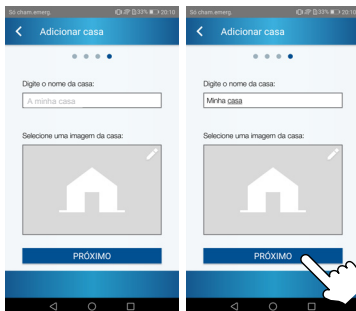
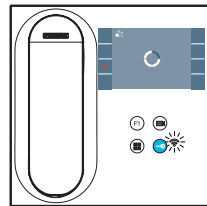
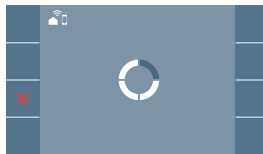

9 Visualiza-se o ecrã para adicionar a vivenda:

- Nome
- Imagem (opcional)

Insira os dados e prima SEGUINTE.



- 11 Se a rede WIFI e as credenciais fornecidas estiverem corretas, o monitor conecta-se à Internet e o processo será concluído com sucesso.



- 12 A aplicação mostrará a nova vivenda vinculada como disponível e conectada (✓ tick verde) e o monitor mostrará o resultado da conexão como bem sucedido. Agora o LED WIFI branco permanece aceso. 📶

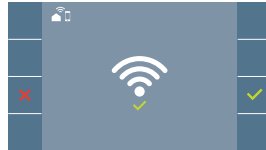

Mensagem de **confirmação** no processo de emparelhamento do monitor.

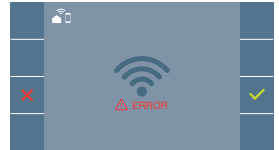

Se não for executado corretamente, mensagem de **erro** no processo de emparelhamento do monitor.

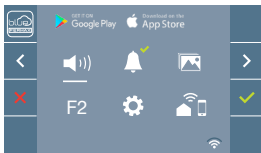

- 13 Uma vez conectado, se o menu do usuário for aberto novamente no monitor, mostrará a intensidade do sinal WIFI no canto inferior direito.

Níveis de intensidade do ícone de sinal wifi apresentado no menu:



Entre 0% e 20% ou monitor não emparelhado.



Entre 20% e 40%



Entre 40% e 60%



Entre 60% e 80%



Entre 80% e 100%



Ligação automática

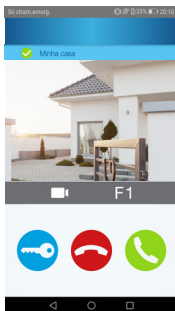
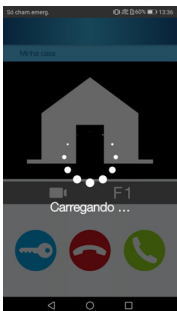

- 14 Para testar o reencaminhamento de chamadas, o usuário pode executar um início automático e verificar se se conecta à botoneira de rua (sempre e quando não estiver a ser usada).



Ajustes parâmetros de usuário:



RESET DE USUÁRIO:

Uma reinicialização (reset) do usuário retorna o status do monitor para não emparelhado (desligado da Internet).

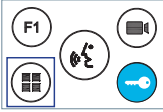
Nota: Este capítulo apresenta os conceitos mais básicos para uma colocação em funcionamento rápida, para mais informações descarregue o manual **Aplicação DUOX PLUS Blue para código móvel. 970156** em www.fermax.com.

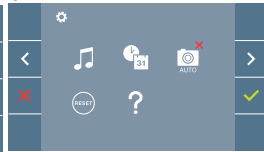
2. PARÂMETROS DO UTILIZADOR: Aceder ao ecrã Parâmetros do usuário.

1  2  3 



Com, > selecionar o ícone  e confirmar com .



2.1 Ajustes da data e hora

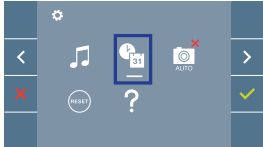

2.2 Captura de imagens



2.1 AJUSTES DA DATA E HORA

O monitor WIFI sincroniza automaticamente a hora com o fuso horário onde está instalado sempre que estiver emparelhado e ligado à Internet. Neste caso, a data e a hora não podem ser alteradas.

1  2  3 

Com >, selecionar o ícone  e confirmar com .

Selecionar o formato da data com  . Depois de selecionada, confirmar com .

Selecionar a data e a hora com   e confirmar . Para navegar pelos ajustes, >.

Data por programar: 01/01/2019 (por predefinição). Aparecerá o ícone , indicando que a data não está correta (data por predefinição). Em caso de corte de alimentação, é reposta a data por predefinição.

Nota: Quando se captura uma imagem com a data por programar, aparece o ícone .

Ícones de notificação de data por programar:

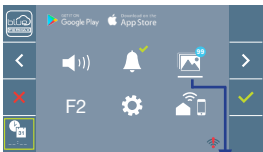
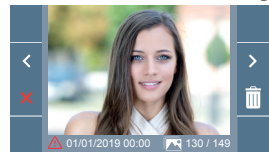
Ecrã Menu do utilizador  **Ecrã Comunicação**  **Ecrã Visualização de imagens** 



Visualização de imagens

2.2 ATIVAÇÃO / DESATIVAÇÃO DA CAPTURA DE IMAGENS

O monitor realizará uma fotografia automática passados 3 segundos de ter recebido uma chamada de uma botoneira de rua. Devido à legislação de proteção de dados ((UE) 2016/679) da União Europeia, a captura de imagens pode ser restrita. Por defeito está desativada, podendo ser ativada no monitor por sua conta e risco.

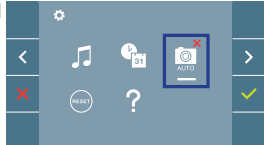
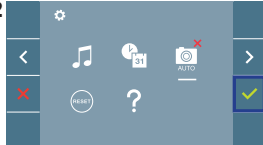
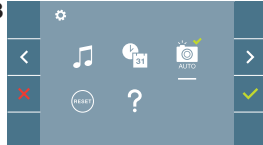
Também obriga a colocar ao lado da placa de rua um aviso indicando que o monitor pode capturar imagens. Pode ser descarregado em <https://www.fermax.com/portugal/corporate/utilidades.html>.

1  2  3 

Selecionar com >, o ícone  e confirmar com .

Premir  para ativar/desativar a função.

es.

Este producto está protegido con las siguientes patentes y modelos de utilidad:

PATENTES: US 9215410, US 9762852, BE1023440, AU2014203706.

MODELOS DE UTILIDAD: ES1187384U, ES1141495U, FR3038192, DE202016000632U1, CN205987229(U).

en.

This product is protected with the following patents and utility models:

PATENTS: US 9215410, US 9762852, BE1023440, AU2014203706.

UTILITY MODELS: ES1187384U, ES1141495U, FR3038192, DE202016000632U1, CN205987229(U).

fr.

Ce produit est protégé par les brevets et modèles d'utilité suivants:

BREVETS: US 9215410, US 9762852, BE1023440, AU2014203706.

MODÈLES UTILITAIRES: ES1187384U, ES1141495U, FR3038192, DE202016000632U1, CN205987229(U).

de.

Dieses Produkt ist durch die folgenden Patente und Gebrauchsmuster geschützt:

PATENTE: US 9215410, US 9762852, BE1023440, AU2014203706.

NUTZMODELLE: ES1187384U, ES1141495U, FR3038192, DE202016000632U1, CN205987229(U).

pt.

Este produto está protegido com as seguintes patentes e modelos de utilidade:

PATENTES: US 9215410, US 9762852, BE1023440, AU2014203706.

MODELOS DE UTILIDADE: ES1187384U, ES1141495U, FR3038192, DE202016000632U1, CN205987229(U).

es. El equipo que ha adquirido está identificado según Directiva 2012/19/UE sobre Residuos de aparatos eléctricos y electrónicos. Mas info:

en. The device you have purchased is identified under Directive 2012/19/EU on waste electrical and electronic equipment. More info:

fr. L'appareil que vous avez acheté porte un marquage conforme à la directive 2012/19/UE relative aux déchets d'équipements électriques et électroniques (DEEE). En savoir plus :

de. Das erworbene Gerät fällt unter die Richtlinien 2012/19/EU über Elektro- und Elektronik-Altgeräte. Weitere Information:

pt. El O equipamento que adquiriu está identificado de acordo com a Diretiva 2012/19/UE relativa aos resíduos de equipamentos elétricos e eletrónicos. Mais informação:





Avd. Tres Cruces, 133
46017 Valencia
Spain

Para más información, visitar www.fermax.com

Contacto: tec@fermax.com / www.fermax.com/contact

For extended information, visit www.fermax.com

Contact: tec@fermax.com / www.fermax.com/contact

Pour de plus amples renseignements, rendez-vous sur www.fermax.com

Contact : tec@fermax.com / www.fermax.com/contact

Für weitere Information siehe www.fermax.com

Kontakt: tec@fermax.com / www.fermax.com/contact

Para informação detalhada, visite www.fermax.com

Contacto: tec@fermax.com / www.fermax.com/contact