



Monitor Veo Duox con Memoria
Duox Veo Monitor with Memory
Moniteur Veo Duox avec Mémoire
Duox Veo Monitor mit Speicher
Monitor Veo Duox com Memória

FERMAX

MANUAL DE INSTALADOR
INSTALLER'S MANUAL
MANUEL D'INSTALLATION
INSTALLATIONSHANDBUCH
MANUAL DO INSTALADOR





¡ENHORABUENA POR DISPONER DE UN PRODUCTO DE CALIDAD!
Fermax electrónica desarrolla y fabrica equipos de prestigio que cumplen los más altos estándares de diseño y tecnología. Esperamos disfrute de sus funcionalidades.

Publicación técnica de carácter informativo editada por FERMAX ELECTRÓNICA S.A.U.

FERMAX ELECTRÓNICA, en su política de mejora constante, se reserva el derecho a modificar el contenido de este documento así como las características de los productos que en él se refieren en cualquier momento y sin previo aviso. Cualquier modificación será reflejada en posteriores ediciones de este documento.







Este producto está protegido con las siguientes patentes y modelos de utilidad:

PATENTES: US 9215410, US 9762852, BE1023440, AU2014203706.

MODELOS DE UTILIDAD: ES1187384U, ES1141495U, FR3038192, DE202016000632U1, CN205987229(U).

Cod. 970159 V04_19

ÍNDICE

	INTRODUCCIÓN	4
	INSTALACIÓN	5
	-Instalación monitor	5
	-Conexiones	6
	CARACTERÍSTICAS TÉCNICAS	8
	DESCRIPCIÓN DE PRODUCTO	9
	- Botones	9
	- Led	10
	- Bucle inductivo	10
	PROGRAMACIÓN	10
	1. Acceder a menú de administrador y de usuario	10
	2. Botones de navegación y pulsadores del monitor	12
	3. Menu administrador	12
	1. Programacion dirección monitor	12
	2. Reset de parámetros	15
	3. Acerca de	15
	4. Menú usuario	15
	1. Ajuste de volumen	16
	2. Función no molestar	16
	3. Visualizar imágenes	16
	4. Función F2	17
	5. Ajustes de parámetros de usuario	17
	5. Ajustes de video y audio	21
	FUNCIONAMIENTO	23
	1. Atender una llamada	24
	2. Activación manual del monitor (Autoencendido)	25
	3. Visualización de imágenes	27



INTRODUCCIÓN

El monitor VEO DUOX incorpora la tecnología DUOX de audio y video, alimentación y datos a través de dos hilos no polarizados.

Las características fundamentales del sistema DUOX son las siguientes:

- Alimentación de los monitores por medio del bus de 18Vdc / 24 Vdc.
- Secreto de conversación.
- Bus no polarizado.

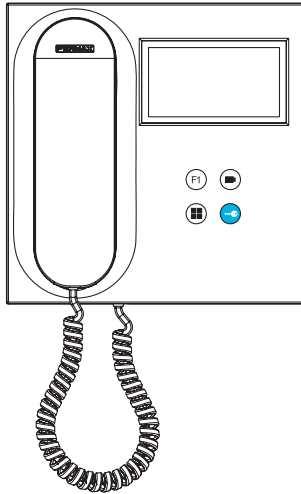

FUNCIONALIDADES

Las funciones disponibles en el monitor VEO DUOX se resumen en la siguiente lista:

- Apertura de puerta.
- Llamada a Conserje.
- Regulación de volumen de llamada.
- Desconexión de llamada (No molestar).
- Selección de melodías.
- Timbre de puerta.
- Programación desde placa, monitor y timbre de puerta.
- Regulación del volumen del audio.
- Configuración de parámetros por menú en pantalla (OSD).
- Ajustes de brillo, contraste y color.
- Funciones auxiliares F1 y F2.
- Bucle inductivo (*según modelo*).
- Captura de imágenes (*con memoria*).

✕ INSTALACIÓN

INSTALACIÓN MONITOR

Conector

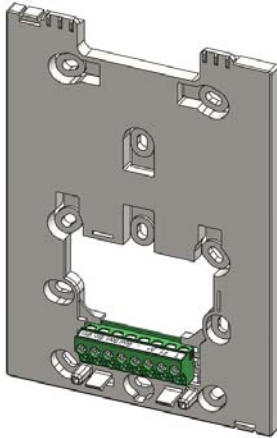

Cableado en superficie

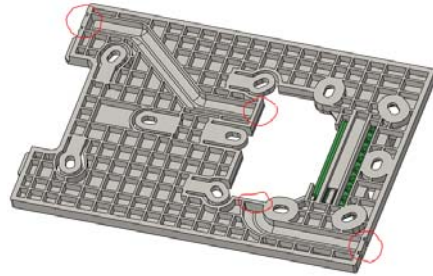

Para instalaciones no empotradas, el conector dispone de dos canales para guiar los cables hasta la regleta de conexión desde suelo o techo. Dos de los tabiques marcados deben eliminarse mediante un alicate de corte para permitir el acceso de los cables desde la cara inferior o superior del conector.

Montaje monitor

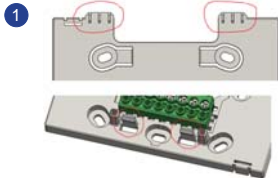

El monitor se cuelga en los dos ganchos superiores del conector y queda retenido a él mediante dos engaces situados en el área inferior.

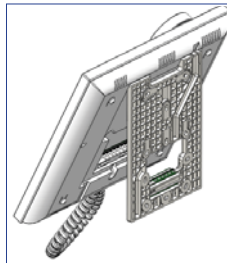

La figura siguiente muestra el monitor durante el colgado en el conector antes de abatirlo para finalizar el montaje.

Situar el monitor frente al conector formando un ángulo entre 15 y 30 grados, colgándolo en los ganchos antes mencionados. Abatir el monitor sobre conector ejerciendo fuerza hacia el muro en ambos lados del extremo inferior hasta escuchar o notar que los enganches inferiores han cerrado.



Para posicionar el monitor y reforzar la retención, el conector tiene dos guías situadas a ambos lados de los enganches.

Desmontaje monitor

a

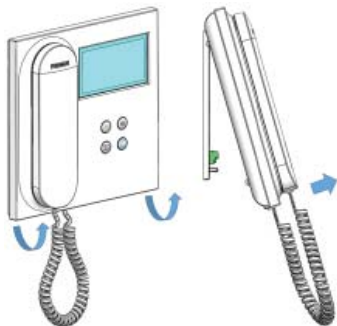

a) Instalado en la pared

El conector está diseñado para desmontar el monitor sin necesidad de herramienta alguna. Para ello, basta con tirar de las esquinas inferiores en dirección perpendicular a la pared hasta desbloquear los engarces y alcanzar un ángulo con la pared de 10 grados mínimo. Entonces, descolgar el monitor de los ganchos superiores del conector.

b

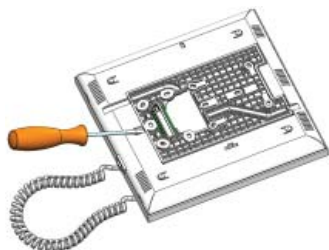

b) Monitor y conector unidos

En el caso de que el monitor y el conector estén unidos, sin estar éste último anclado a un muro, es necesario utilizar un destornillador plano para hacer palanca y separarlos como se indica.

CONEXIONES

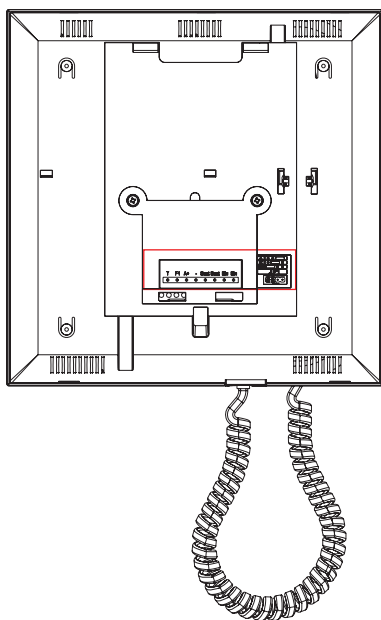

Conectores Monitor:

Bin,Bin: Datos, audio y video entrada.

Bout,Bout: Datos, audio y video entrada (*conexión en cascada*).

T, -: Pulsador de llamada puerta vivienda (P1).

A+, -: Posibilidad conexión siguientes equipos:

- Prolongador de llamada ref. 2040.
- Activador de Luces y timbres ref. 2438.

F1: Función adicional. (*Salida negativo “-” / envío de comando, ver capítulo Botones: **Función auxiliar F1***).

JP1: Puente adaptador de línea integrado

- Arriba: Adaptación tipo A.
- Centro: Adaptación tipo C.
- Abajo: Sin adaptación de línea: OFF, (por defecto).

DISTRIBUCIÓN

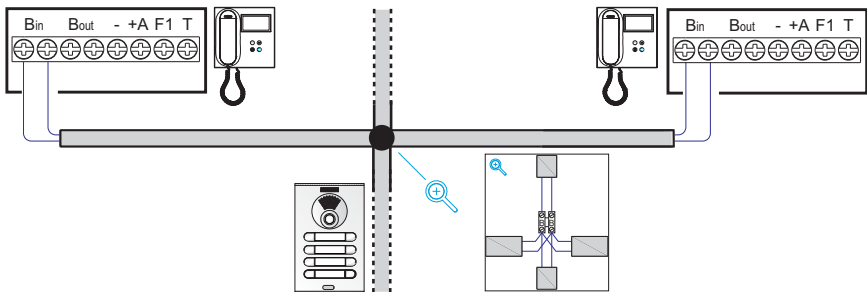

CASCADA

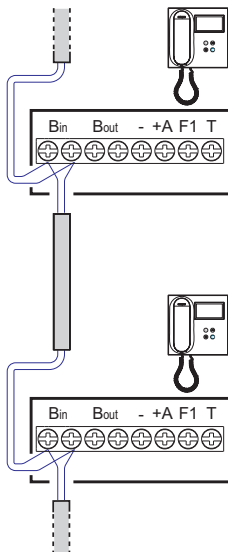

AMPLIACIONES:

- Prolongador de llamada: Ref. 2040
- Timbre de puerta: P1

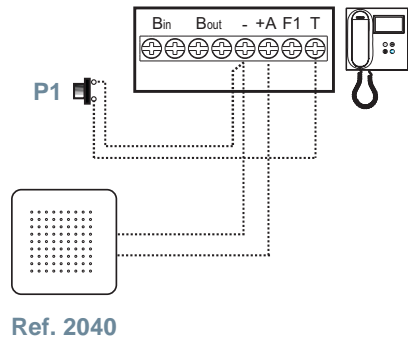

AMPLIACIONES: Activador de luces y timbres Ref. 2438

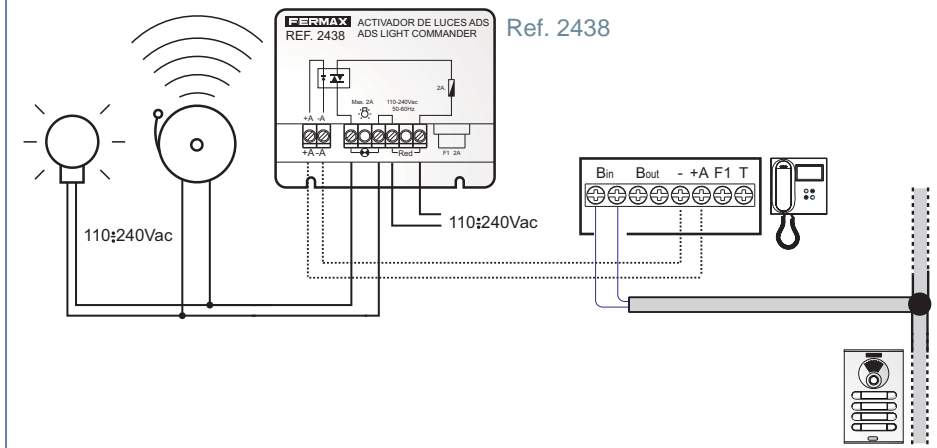

CARACTERÍSTICAS TÉCNICAS

Alimentación (sin polaridad)	18 - 24 Vdc
Consumo	
Consumo en reposo	0,8 W
Consumo máximo	5,2 W
Número de terminales por vivienda	3
Dirección de cada monitor: 6 dígitos	000001...999999
Temperatura de funcionamiento	[-5° , +40°C] / [23°, 104°F]
Humedad	[0% - 90%]
Pantalla OSD	TFT 4.3"
Resolución	
Hor.:	480 Line TV
Ver.:	272 Line TV
Dimensiones monitor (Alto x Ancho x Profundo)	200 x 200 x 46mm - 8" x 8" x 1.8"

Nota importante: Este monitor VEO es compatible con Monitores VEO y VEO XS con versiones V2.x y V3.x.

Si se sustituye alguno de los monitores de las versiones indicadas, también se deberá cambiar el conector del monitor. El conector del monitor actual tiene la referencia 9447.



DESCRIPCIÓN DE PRODUCTO

Monitor VEO

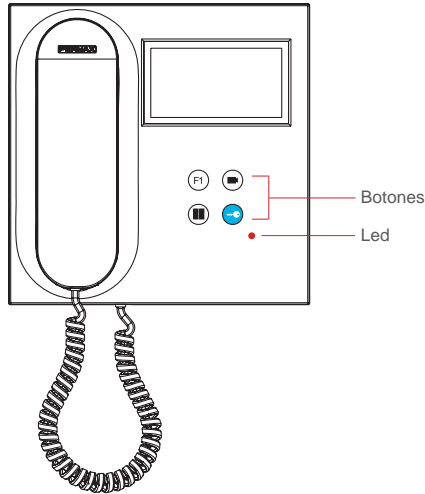

BOTONES



Botón de abrepuertas / llamada a conserje.

- Estando en comunicación con la Placa de Calle (*audio solo o video sólo o audio+video*), al pulsar este botón se activa el abrepuertas.
- Con el brazo colgado (*monitor en reposo*), al pulsar este botón se realiza una llamada al conserje (si existe conserjería y el monitor está en modo día o mixto).



Botón Autoencendido.

Conexión con cámara del Bloque o de la Entrada General (*función disponible según tipo de instalación, ver capítulo **Funcionamiento: Autoencendido***).



Función Auxiliar F1

Función auxiliar (salida negativo "-" / envío de comando).

Envío de negativo: *Salida de negativo por la borna F1 al pulsar el botón F1 y también envía un comando F1 de activación para poder activar un dispositivo auxiliar.*



Botón Menú.

· Para acceder a:

- **Menú de Programación**, se accede cuando el monitor no está programado. Desde este menú, se puede realizar la programación del monitor según necesidades de la instalación.
- **Menú de Usuario**, (una vez programado el monitor). Desde este menú, se puede acceder a los ajustes de usuario para su personalización.

LED

● Led Rojo:

Intermitente rapido. Monitor sin programar.

Intermitente lento. Indica que la función no molestar está activada.

Encendido. Monitor en reposo.

Bluce Inductivo

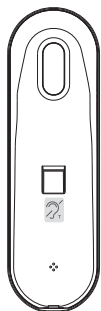

Bucle inductivo. Viene identificado con esta etiqueta (*según modelo*). Existe un modelo del monitor VEO con bucle inductivo en el brazo del monitor. [Ver 97507 Brazo Teléfono bucle inductivo en www.fermax.com](http://www.fermax.com).

- Incluye un bucle que interactúa con los dispositivos de audición de personas con discapacidad auditiva.

Nota: En dispositivos de audición con selección manual de modo, debe estar configurado el Modo Digital.



PROGRAMACIÓN:

1. PROGRAMACIÓN: ACCEDER A MENÚ DE ADMINISTRADOR Y DE USUARIO

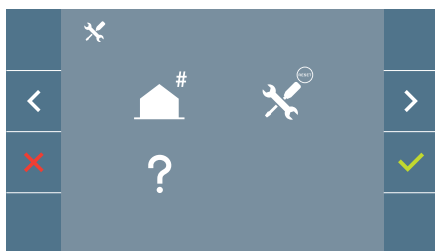

Pantalla: Menú ADMINISTRADOR

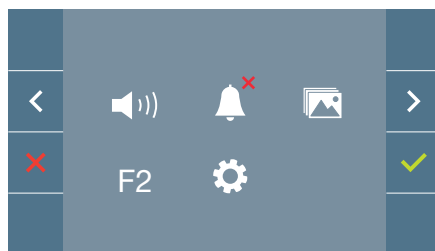

Pantalla: Menú USUARIO

Los iconos de No Molestar (*Pantalla: Menú Usuario*) y Captura de Imagen (*Pantalla Menú Usuario. Opción Parámetros de usuario*) cambiarán dependiendo de si están activados/desactivados. Si están activados se mostrará un tick verde ✓ en la parte superior derecha del icono, mientras que si están desactivados se mostrará una cruz roja ✗.

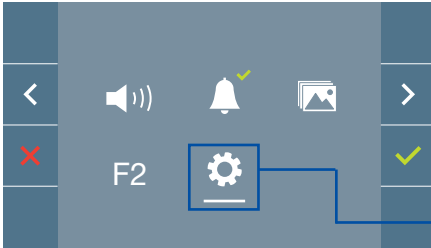

Pantalla: Menú USUARIO

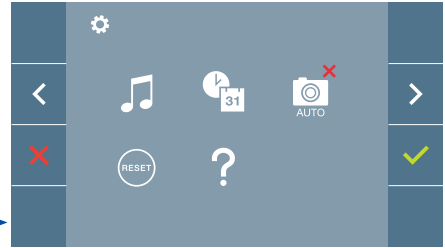

Pantalla: Opción Parámetros de usuario del Menú USUARIO.

Pulsando el botón  **MENÚ**, se accede directamente:

- A la opción de Programación del monitor del Menú de Administrador, si el monitor no está programado.
- A la pantalla del Menú de Usuario si el monitor está programado.

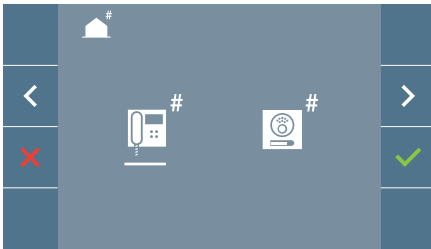

Pantalla: Opción Programación del monitor del Menú ADMINISTRADOR.

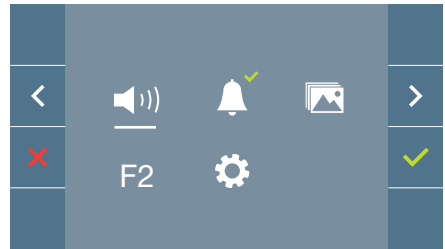

Pantalla: Menú USUARIO

Para acceder al Menú de Administrador cuando el monitor está programado se deben realizar dos pasos:

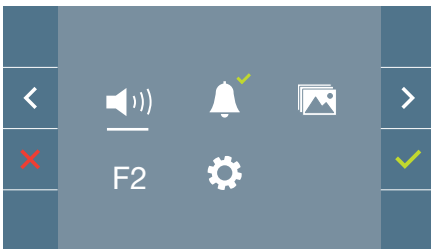

1. Pulsar el botón  **MENÚ**, se accede a la pantalla del **Menú de Usuario**.



2. Estando en la pantalla del Menú de Usuario, pulsar simultáneamente los botones:



2. PROGRAMACIÓN: BOTONES DE NAVEGACIÓN Y PULSADORES DEL MONITOR

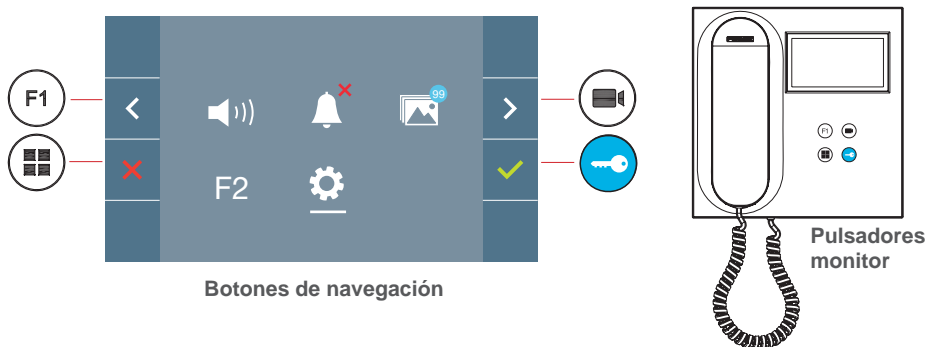

Los iconos visualizados en la pantalla (*botones de navegación: , , y*), se manejan con los pulsadores correspondientes ubicados en el monitor:

- : Volvemos a la pantalla anterior o stand-by.
- : Seleccionamos la opción previa del menú.
- : Marcamos la siguiente opción del menú.
- : Confirma la selección y activa la función.

Notas:

- La línea blanca abajo del icono indica en la función en la que nos encontramos. Al pulsar se selecciona.
- El monitor sale de programación automáticamente, tras 60 segundos de inactividad.

3. PROGRAMACIÓN: Pantalla MENÚ ADMINISTRADOR

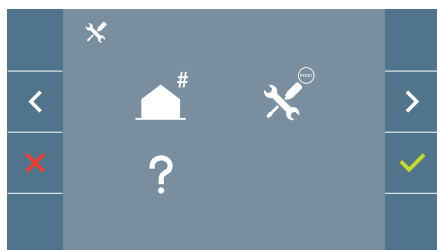

Existen varias opciones:

1. Programación de la dirección del Monitor.
2. Reset de parámetros.
3. Acerca de.

3.1 MENÚ ADMINISTRADOR: PROGRAMACIÓN dirección monitor

¡El monitor no funcionará mientras no haya sido programado!

Nota: El led rojo parpadeando lento indica que el monitor está sin programar y una vez programada la dirección del monitor el led rojo se apaga.

Existen tres opciones para programar el monitor desde:

- a) Desde Monitor.
- b) Desde Placa.
- c) Desde Timbre de puerta.

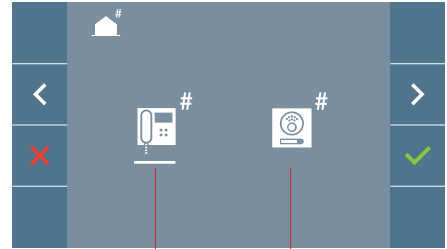

Desde Monitor Desde Placa

a) Desde Monitor.

Es posible programar el monitor mediante el menú en pantalla.

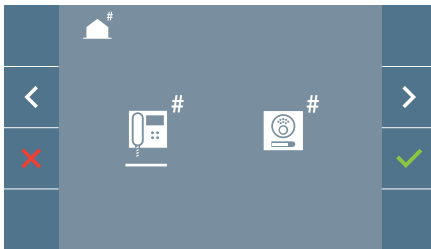

Programar el número de llamada: Pulsar en la pantalla y se accede a la pantalla para programar el número de vivienda (*números de derecha a izquierda*).

Cada vez que se presiona el **+** se incrementa el número (*empezando por el 1*) y la **flecha** se utiliza para el desplazamiento. Un cursor blanco indica la posición de introducción del dígito. Programar el número correspondiente y aceptar con . Una vez programada la dirección del monitor se indica mediante el led rojo fijo.

b) Desde Placa.

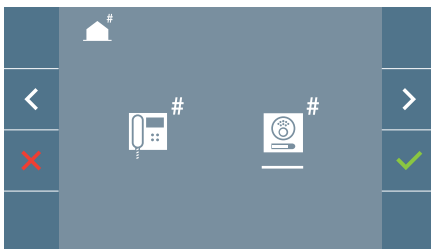

Opción seleccionada mediante la línea blanca abajo del icono. Pulsar , se escucha un bip en el monitor.

Automáticamente el monitor se conecta con la placa de calle activando la cámara. Introducir desde la placa el código de llamada para ese monitor. Dependiendo del tipo de placa instalada:

- Pulsando el pulsador correspondiente
- Introduciendo el código + campana.

Notas:

- El tiempo desde que se escucha el bip de confirmación de entrada en programación del monitor y se produce la llamada desde la placa para programar la dirección del monitor, debe ser inferior a 2 minutos y medio.
- La placa desde la que se realiza la programación debe estar como placa máster.

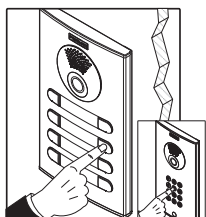
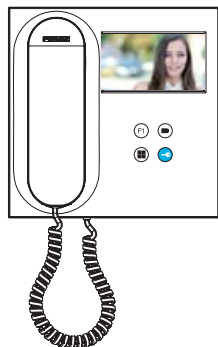

Se produce un tono de llamada diferente, confirmando la programación del monitor y se sigue visualizando la imagen de la cámara. Transcurridos unos segundos el monitor vuelve a reposo. Una vez programada la dirección del monitor se indica mediante el led rojo fijo.

c) Desde Timbre de puerta.

A través de la entrada del timbre de puerta T y - también se puede programar la dirección del monitor.

Para poder realizar este tipo de programación, el monitor no debe estar programado previamente.

Pulsar el timbre de puerta durante 5 segundos, se escuchara el bip de confirmación de entrada en programación del monitor.

Automáticamente el monitor se conecta con la placa de calle activando la cámara. Introducir desde la placa el código de llamada para ese monitor, dependiendo del tipo de placa instalada:

- Pulsando el pulsador correspondiente.
- Introduciendo el código + campana.

Se produce un tono de llamada diferente, confirmando la programación del monitor y se sigue visualizando la imagen de la cámara. Transcurridos unos segundos el monitor vuelve a reposo. Una vez programada la dirección del monitor se indica mediante el led rojo fijo.

Notas:

- El tiempo desde que se escucha el bip de confirmación de entrada en programación del monitor y se produce la llamada desde la placa para programar la dirección del monitor, debe ser inferior a 2 minutos y medio.
- La placa desde la que se realiza la programación debe estar como placa máster.

3.2 MENÚ ADMINISTRADOR: **RESET DE PARÁMETROS**

El instalador puede resetear los parámetros para dejar al monitor con la configuración por defecto, seleccionando y confirmando la opción.

El reset afecta tanto a los parámetros de configuración del usuario como a la dirección del monitor.

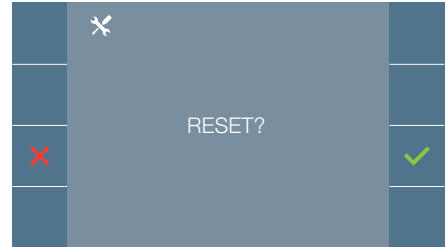

Nota: El led rojo parpadeando rápido indica que el monitor está sin programar. Como el reset borra la dirección del monitor programada, cuando el led esté parpadeando indicará que el reset ya ha finalizado.

3.3 MENÚ ADMINISTRADOR: **ACERCA DE**

En pantalla se muestra un código QR que permite acceder a la documentación completa del monitor.

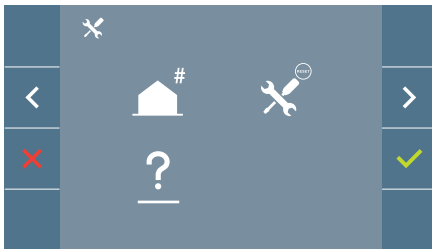

4. PROGRAMACIÓN: **Pantalla MENÚ USUARIO**

Pulsando el botón  MENÚ, se accede directamente a la pantalla del Menú de Usuario si el monitor está programado.

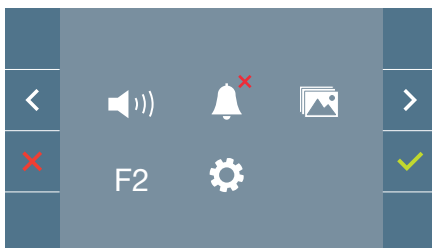

- Existen varias opciones:
1. Ajuste de volumen del monitor
 2. Función no molestar
 3. Visualizar imágenes
 4. Función F2
 5. Ajustes parámetros de usuario

4.1 MENÚ USUARIO: AJUSTE DE VOLUMEN DEL MONITOR

Es posible ajustar el volumen de melodía en un rango de diez posibles valores.

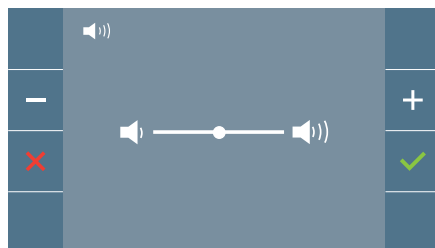
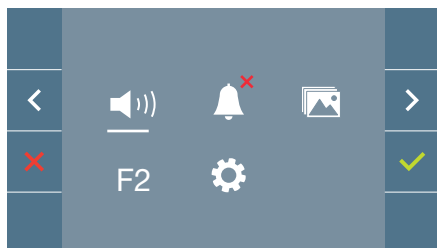

En primer lugar se muestra y se escucha el volumen actual que podrá ir aumentando (+) o decrementando (-) con los botones correspondientes. Por medio de éstos obtener la regulación deseada.

4.2 MENÚ USUARIO: MODO NO MOLESTAR

Desde este icono se permite activar/desactivar el tono de llamada (*modo no molestar*).

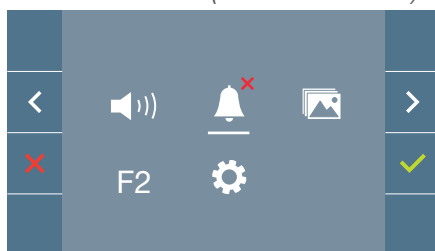
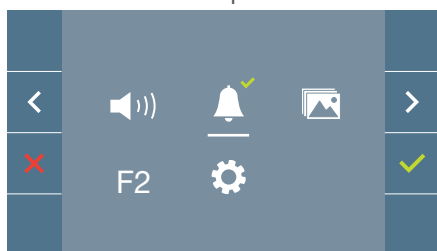

Pulsar el icono ✓ para cambiar la selección. Por defecto está seleccionado el funcionamiento normal (*se escucha la llamada*).

El led rojo del monitor parpadea lento cuando está activo el modo no molestar.

4.3 MENÚ USUARIO: VISUALIZAR IMÁGENES

Desde este icono se permite visualizar las imágenes capturadas automáticamente y borrarlas. Para mas información [ver capítulo Funcionamiento: Visualización de Imágenes.](#)

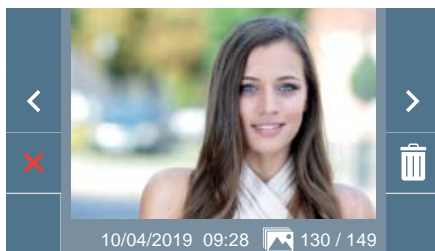
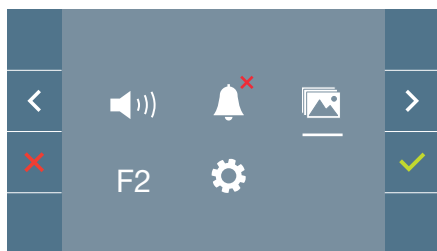

4.4 MENÚ USUARIO: **FUNCIÓN F2**

La función F2 envía un comando de activación para poder activar un dispositivo auxiliar. En la pantalla se notificará la acción: F2 ON durante 3 segundos. Esta función está en la pantalla principal del menú de usuario.

Se envía por el bus el comando F2 incluyendo la dirección del monitor para activar el dispositivo auxiliar conectado al bus como por ejemplo un relé duox, (*consulte con su instalador*).

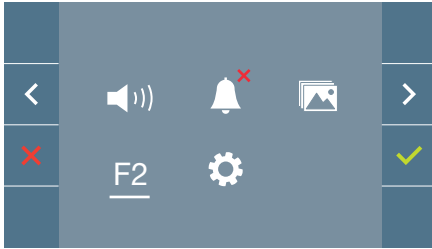

4.5 MENÚ USUARIO: **AJUSTES PARÁMETROS DE USUARIO**

Dentro del menú de usuario al seleccionar la opción «Ajustes parámetros de usuario», se accede a una nueva pantalla correspondiente a diferentes parámetros de configuración:

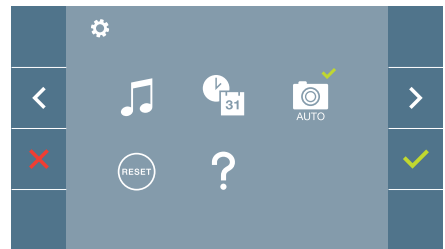
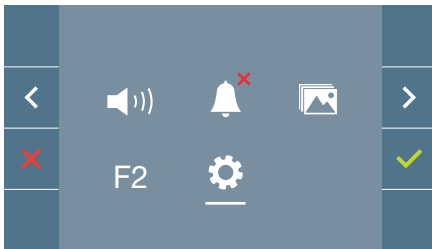

Los parámetros son los siguientes:

1. Selección de melodías
2. Ajuste fecha y hora
3. Activación/Desactivación Captura de imágenes
4. Reset de los parámetros de configuración
5. Ayuda de usuario

4.5.1 Ajustes parámetros de usuario: **SELECCIÓN DE MELODÍAS**

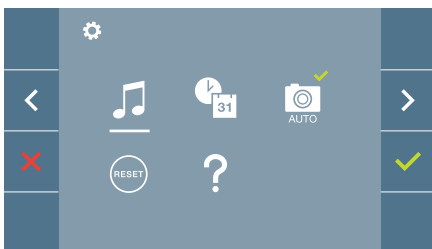

El monitor permite seleccionar una melodía independiente para las placas y para la conserjería. Las placas son:

- Placa 0 del Bloque del monitor.
- Placa 1 del Bloque del monitor.
- Placa 0 de la Entrada General.

Permite asignar entre 5 tonos diferentes de melodías.

a) Selección melodía placa

Placa 0 del Bloque del monitor

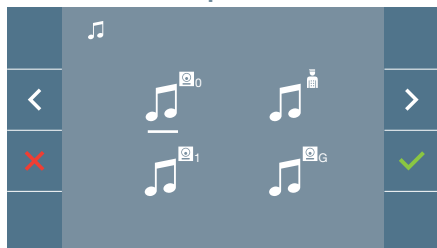

Seleccionando esta opción se puede cambiar la melodía que se escuchará en el monitor cuando se realice una llamada desde la placa de la calle 0 del bloque del monitor.

Placa 1 del Bloque del monitor

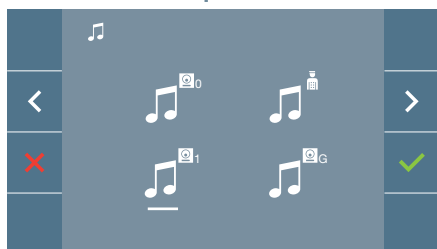

Seleccionando esta opción se puede cambiar la melodía que se escuchará en el monitor cuando se realice una llamada desde la placa de la calle 1 del bloque del monitor.

Placa 0 de la Entrada General

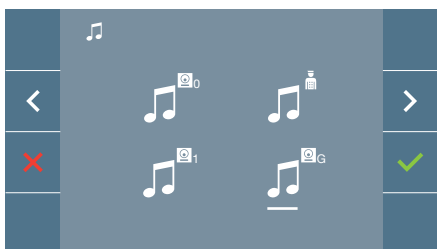

Seleccionando esta opción se puede cambiar la melodía que se escuchará en el monitor cuando se realice una llamada desde la placa de la calle 0 de la entrada general.

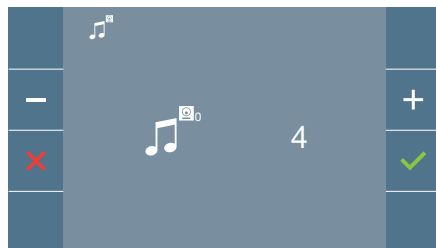

Una vez seleccionada la opción, muestra y se escucha la melodía actual, pulsando el botón **+** o **-** se pueden ir seleccionando y escuchando las diferentes melodías disponibles en el monitor.

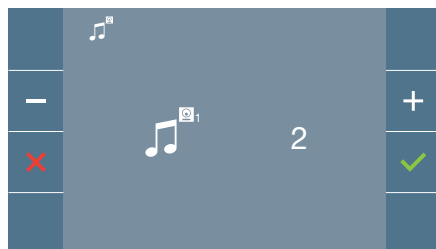

Una vez seleccionada la opción, muestra y se escucha la melodía actual, pulsando el botón **+** o **-** se pueden ir seleccionando y escuchando las diferentes melodías disponibles en el monitor.

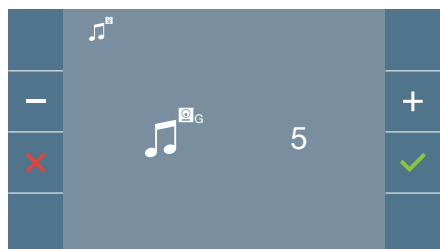

Una vez seleccionada la opción, muestra y se escucha la melodía actual, pulsando el botón **+** o **-** se pueden ir seleccionando y escuchando las diferentes melodías disponibles en el monitor.

b) Selección melodía conserjería

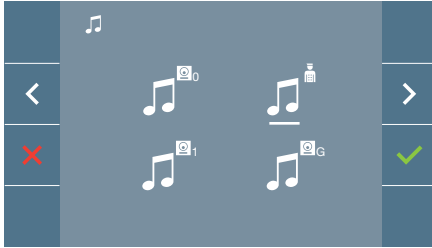

Seleccionando esta opción se puede cambiar la melodía que se escuchará en el monitor cuando la conserjería realice una llamada al monitor.

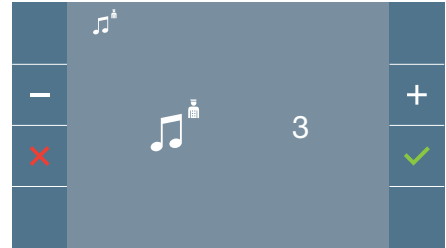

Una vez seleccionada la opción, muestra y se escucha la melodía actual, pulsando el botón + o - se pueden ir seleccionando y escuchando las diferentes melodías disponibles en el monitor.

4.5.2 Ajustes parámetros de usuario: AJUSTES DE FECHA Y HORA

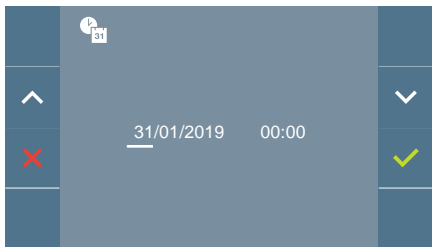
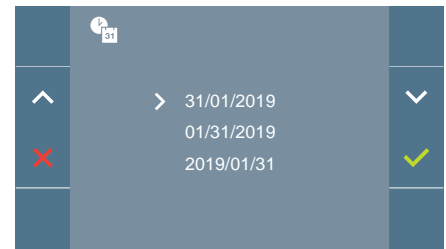
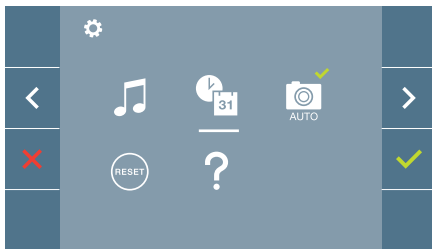



El monitor permite ajustar la fecha y la hora.

A través de los iconos de navegación se puede cambiar los ajustes de fecha y hora y navegar por éstos. Pulsar el icono ✓ para confirmar la selección.

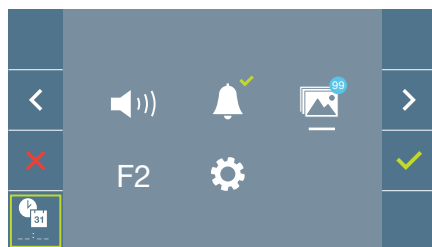
Si por algún motivo se pierde la alimentación, la configuración de fecha y hora pasará a ser la configuración por defecto (01/01/2019). En el monitor aparecerá en el menú de usuario y en la pantalla de video un icono indicando que la fecha no es correcta.



Notas:

- No se permite validar con datos incorrectos de fecha y hora.
- Manteniendo pulsados los iconos de navegación  -  los números cambian más deprisa.

4.5.3 Ajustes parámetros de usuario: **ACTIVACIÓN/DESACTIVACIÓN CAPTURA DE IMÁGENES**

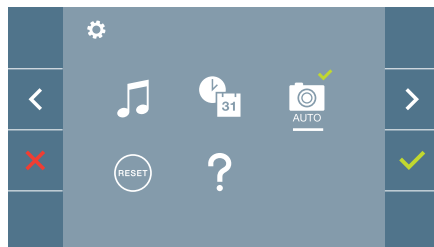
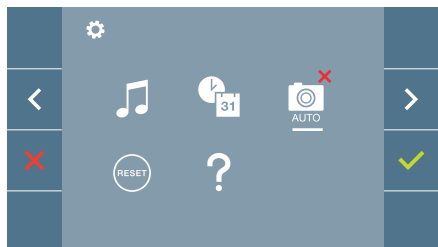

Desde esta opción se puede activar/desactivar la captura automática de imágenes. Seleccionar el icono de captura de imágenes y pulsar confirmar  para activar/desactivar.

El monitor puede realizar una foto automática a los 3 segundos de recibir una llamada de una placa de calle. Por la legislación de protección de datos ((EU) 2016/679) de la Unión Europea puede restringirse la captura de imágenes. Por defecto está desactivada, se puede activar desde el monitor bajo su responsabilidad.

Así mismo podría obligar a colocar junto a la placa de calle un cartel indicando que el monitor puede capturar imágenes. Puede descargarlo en <https://www.fermax.com/spain/corporate/utilidades.html>.

4.5.4 Ajustes parámetros de usuario: **RESET DE USUARIO**

Con esta opción se pueden resetear todos los parámetros de configuración a valores de fábrica, conservando la dirección programada en el monitor y la activación del bucle inductivo. Seleccionando y confirmando la opción.

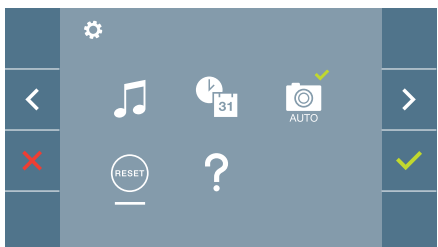

Si se desea realizar el reset confirmar la opción.

4.5.5 Ajustes parámetros de usuario: **AYUDA**

En pantalla se muestra un código QR que permite acceder a un enlace promocional que explica en detalle el sistema digital DUOX creado por FERMAX.

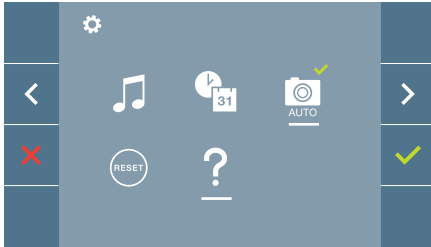

5. AJUSTES: VIDEO Y AUDIO

5.1 AJUSTES: **AJUSTE VIDEO: BRILLO - CONTRASTE - COLOR**

El monitor permite realizar los ajustes de brillo, contraste y color mientras se haya recibido una llamada (*sin descolgar/sin establecer comunicación*) o realizando un autoencendido (cámara). [Ver capítulo **Funcionamiento: Autoencendido**.](#)

Teniendo la imagen de video en la pantalla, realizar una pulsación corta en el botón (Menú) y aparecerá en pantalla un menú contextual para el ajuste del brillo, contraste y color de la imagen.

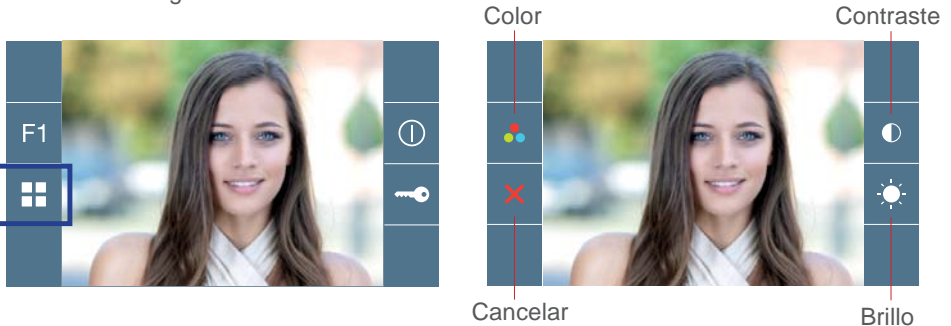

1. Seleccionar los ajustes de contraste, brillo y color, con los botones correspondientes.

Desde estas pantallas también se puede activar el audio (*descolgar/establecer comunicación*).

Nota: El tiempo para realizar los Ajustes de Video es de 30 segundos, transcurrido este tiempo el monitor volverá a reposo.

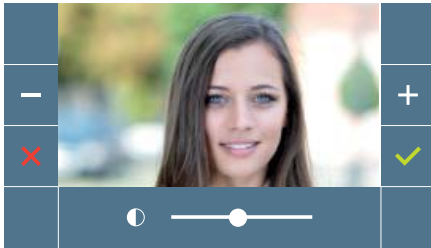

Contraste



Brillo

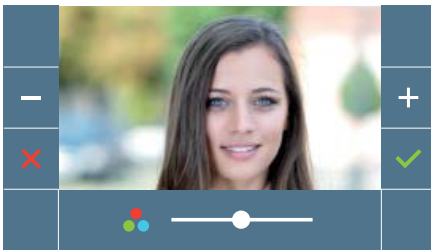

Color

5.2 AJUSTES: AJUSTE AUDIO

Durante el tiempo que está abierto el canal de audio se puede regular el volumen del audio. Para realizar el ajuste de audio, pulsar el botón  (menú) y aparecerá en pantalla un menú contextual para dicho ajuste.

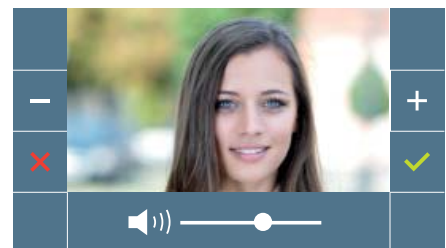

 Manual Usuario: FUNCIONAMIENTO

FUNCIONAMIENTO

1. FUNCIONAMIENTO: **ATENDER A UNA LLAMADA. Recepción de llamada.**

Al presionar el pulsador de llamada en la **Placa de Calle**, se produce un tono de llamada en ésta y en el monitor además de encenderse la pantalla. Se dispone de 30 segundos para contestar antes de que regrese a la situación de reposo. Durante éste tiempo el led rojo se apagará para saber que está la llamada pendiente de contestar.

Se puede descolgar el brazo y mantener una conversación con la placa de calle. La comunicación finalizará automáticamente a los 90 segundos o en cualquier momento al colgar el brazo del teléfono.

Notas:

- *En caso de haber varios monitores/teléfonos en la misma vivienda sólo conseguirá audio el primero que descuelgue, volviendo a reposo el resto de monitores/teléfonos. Si se intenta descolgar alguno de ellos se obtendrá un tono de línea ocupada.*
- *Si no se establece comunicación (descolgando el brazo) con la placa de calle, el monitor se apaga automáticamente pasados 30 seg.*

Al recibir una llamada desde la placa de calle, es posible abrir la puerta en cualquier momento, pulsado el botón .

1.1 Llamada de Video.

En el caso de que en la vivienda se reciba una llamada desde una placa de vídeo, el monitor mostrará el vídeo capturado por la cámara en la placa de calle.

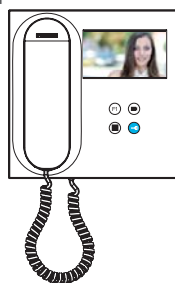

1.2 Llamada de Audio.

En el caso de que en la vivienda se reciba una llamada desde una placa de audio, el monitor mostrará la siguiente pantalla:

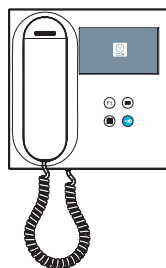

1.3 Llamada a Conserje.

Si un monitor se encuentra configurado en modo MIXTO o modo DÍA, al pulsar el botón de abrepuertas estando en reposo, éste iniciará una llamada a la última conserjería que lo configuró en este modo. La pantalla del monitor mostrará la imagen siguiente y sonará un tono de RINGING.

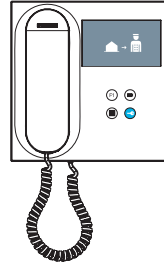

En caso de recibir una llamada del conserje en el monitor de la vivienda, se mostrará la imagen siguiente:

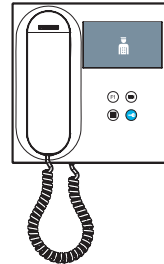
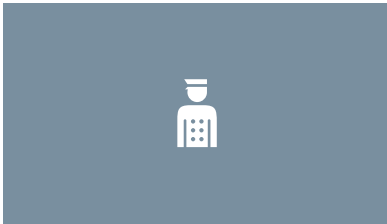

2. FUNCIONAMIENTO: ACTIVACIÓN MANUAL DEL MONITOR (AUTOENCENDIDO)

Con el monitor en reposo pulsar el botón  (*cámara*), para encender manualmente el monitor.

Las temporizaciones de previsualización sin audio (30seg.) o conversación (90seg.) en total, aunque se cambie de cámara.

Autoencendido en reposo:

1. Si la anterior llamada desde la placa finalizó hace menos de 15 segundos, se realiza la rellamada a dicha placa: **R.**



2. Si el punto anterior no ocurre, comienza el autoencendido con las diferentes placas que tenga visibles el monitor.

Pulsando secuencialmente Placa 0, Placa 1, Placa General, (según disponibilidad de placas).

- 1 Placa 0 o Cámara 0 del Bloque del monitor.
- 2 Placa 1 o Cámara 1 del Bloque del monitor.
- 3 Placa 0 o Cámara 0 de la Entrada General.

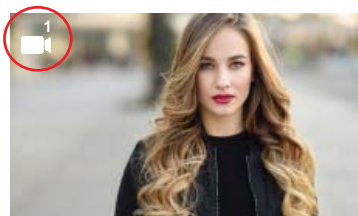

Una vez establecida la comunicación con una placa, se puede cambiar la misma pulsando el pulsador  (cámara).

Autoencendido en estado de llamada recibida:

1. Si la llamada corresponde a una placa de la secuencia descrita en el punto anterior, se prosigue el autoencendido a la siguiente placa de la secuencia.
2. Si la llamada NO es de placa, se comienza el autoencendido con la placa de bloque 0, (según disponibilidad de placas), y sigue la secuencia:



1 Placa 0 o Cámara 0 del Bloque del monitor



2 Placa 1 o Cámara 1 del Bloque del monitor



3 Placa 0 o Cámara 0 de la Entrada General

Notas:

- El autoencendido sólo se puede realizar con las placas indicadas. Si no puede realizar el autoencendido, consulte con su instalador. Al completar los intentos de conexión con cada una de las tres posibles placas si no se puede, el monitor emitirá un tono de error y vuelve al estado de reposo.
- Finalizada cualquier comunicación con una placa, durante 15 segundos si se vuelve a pulsar el botón de autoencendido se conectará con dicha placa.
- El autoencendido sin establecer audio, si se realiza la apertura de la puerta a los 5 segundos finalizará la llamada.
- En el caso de que un segundo monitor realice un autoencendido se distinguen varios casos:
 - o El primer monitor está en autoencendido, y no ha establecido una conversación con audio: En este caso no se permite el autoencendido del segundo monitor.
 - o El primer monitor ha realizado un autoencendido y ha establecido una conversación de audio: se permite el inicio del establecimiento de autoencendido.
 - o En cualquier caso, al finalizar la conversación o el autoencendido sólo con video del primer monitor, se permite que el segundo monitor inicie el autoencendido.

3. FUNCIONAMIENTO: VISUALIZACIÓN DE IMÁGENES

Función para ver todas las capturas de imágenes realizadas. La función de captura de imágenes debe estar previamente activada. [Ver capítulo 4.5 Menú USUARIO - 4.5.3 Activación/Desactivación de imágenes.](#)

Al realizar una llamada desde la placa de calle (la función de captura de imágenes debe estar previamente activada), transcurridos 3 segundos se realiza automáticamente una foto, que se almacena en la memoria.

Nota: El número máximo de imágenes que se pueden almacenar son 150, si se almacena una nueva imagen con la memoria llena se borrará la imagen más antigua.

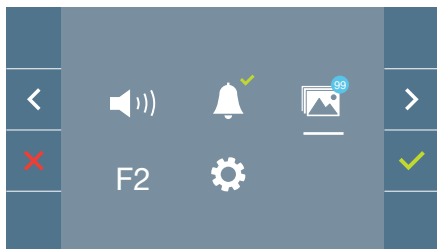

Seleccionar el icono  para visualizar las diferentes fotos realizadas.

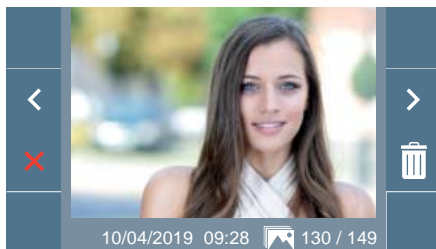

Se muestra la imagen más reciente con la fecha, hora y número de foto.



Aparece un menú contextual:

  : Para seleccionar/visualizar fotos guardadas.

 : Para borrar imágenes.

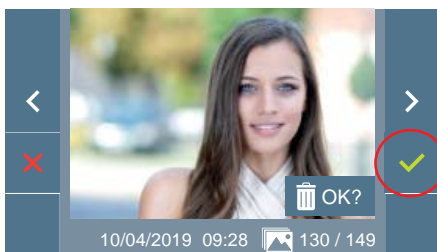
 : Para cancelar e ir a la pantalla anterior.



Si se pulsa la opción de borrado  se accede a la pantalla de confirmación de borrado de imágenes, pulsando el icono de confirmar  se borrará la foto seleccionada. El usuario puede navegar a través de las fotos guardadas, incluso cuando la ventana de confirmación está activa.

Nota: Si se mantiene pulsado el icono de confirmar  durante 5 segundos se pueden borrar todas las imágenes, previa confirmación.

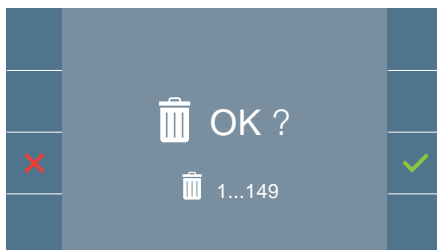

En el caso de que haya capturas de imágenes que no hayan sido visualizadas por el usuario aparecerán notificaciones en el icono del menú de usuario y en la pantalla de video.

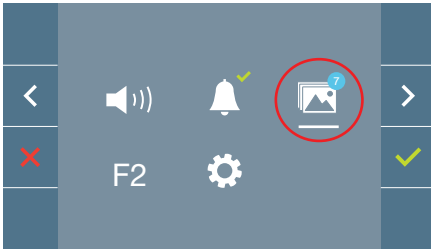

El icono de visualización de imágenes cambia mostrando un círculo azul con el número de imágenes por visualizar (máximo 99). En el círculo se habrán descontado el número de imágenes visualizadas por el usuario.



Cuando se produce una llamada, se informa de que existen fotos sin visualizar, no especifica en este caso el número.

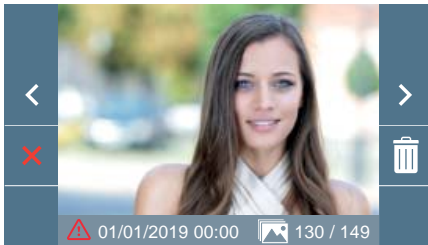

Si por algún motivo se pierde la alimentación en el monitor, la configuración de fecha y hora pasará a ser la configuración por defecto (01/01/2019).

Si se captura una imagen sin haber ajustado la fecha y hora, en la visualización de la imagen aparecerá este icono , indicándonos que los ajustes de fecha y hora que aparecen junto a la imagen no son correctos.



El equipo que ha adquirido está identificado según Directiva 2012/19/UE sobre Residuos de aparatos eléctricos y electrónicos. Mas info:





CONGRATULATIONS FOR BUYING A QUALITY PRODUCT!

Fermax Electrónica develops and manufactures premium equipment that meets the highest design and technology standards. We hope you will enjoy all its functions.

Technical publication for information purposes edited by FERMAX ELECTRÓNICA S.A.U.

FERMAX ELECTRÓNICA applies a continuous improvement policy, therefore it reserves the right to modify the contents of this document, as well as the product features hereof at any time and without prior notice. Any modification will be reflected in subsequent editions of this document.







This product is protected with the following patents and utility models:

PATENTS: US 9215410, US 9762852, BE1023440, AU2014203706.

UTILITY MODELS: ES1187384U, ES1141495U, FR3038192, DE202016000632U1, CN205987229(U).

Code 970159 V04_19

INDEX

	INTRODUCTION	4
	INSTALLATION	5
	-Monitor installation	5
	-Connections	6
	TECHNICAL SPECIFICATIONS	8
	PRODUCT DESCRIPTION	9
	- Buttons	9
	- LED	10
	- Induction Loop	10
	PROGRAMMING	10
	1. Access administrator and user menu	10
	2. Navigation buttons and monitor push-buttons	12
	3. Administrator menu	12
	1. Monitor address programming	12
	2. Reset settings	15
	3. About	15
	4. User menu	15
	1. Volume setting	16
	2. Do Not Disturb function	16
	3. Display images	16
	4. F2 Function	17
	5. User parameter settings	17
	5. Video and audio settings	21
	Operation	23
	1. Answering a call	24
	2. Activating the monitor manually (Auto-On)	25
	3. Displaying images	27



INTRODUCTION

The VEO DUOX monitor incorporates DUOX technology for audio and video, power and data through two non-polarised wires.

The fundamental characteristics of the DUOX system are as follows:

- Monitor powered via 18Vdc / 24 Vdc bus.
- Private conversation.
- Non-polarised bus.

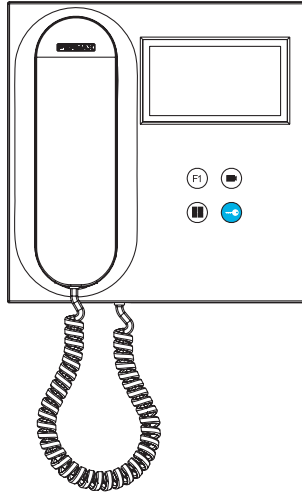

FUNCTIONS

The functions available on the VEO DUOX monitor are presented in the following list:

- Door release.
- Concierge calls.
- Ring tone volume.
- Call disconnection (Do Not Disturb)
- Melody selection.
- Doorbell.
- Programming from panel, monitor and doorbell.
- Audio volume.
- Parameter configuration by on-screen display (OSD).
- Brightness, contrast and colour settings.
- Auxiliary Functions F1 and F2.
- Induction loop (*according to model*).
- Video capture (*with memory*)

✕ INSTALLATION

MONITOR INSTALLATION

Connector

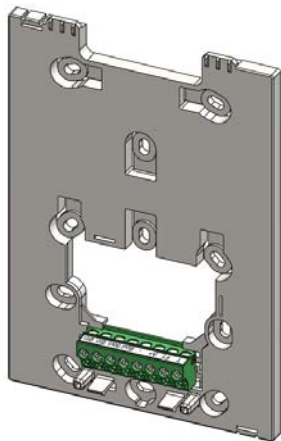

Surface wiring

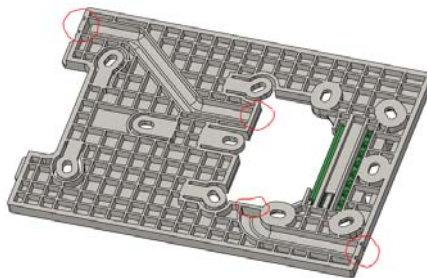

For non-embedded installations, the connector has two channels to guide the cables to the connection strip from the floor or ceiling. Two of the marked partitions must be removed with cutting pliers to create access for the cables from the bottom or top of the connector.

Mounting the monitor

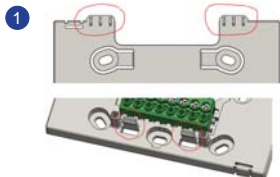

The monitor is to be hung from the two upper hooks on the connector and held in place by two clips in the lower area.

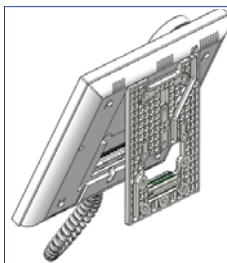

The following diagram shows the monitor as it is being hung onto the connector, before it is tilted down to complete the assembly.

Hold the monitor in front of the connector at an angle between 15 and 30 degrees and hang it on the aforementioned hooks. Tilt the monitor down over the connector and exert force towards the wall on both sides of the lower end until you hear or notice that the lower clips have closed.



To position the monitor and keep it firmly attached, the connector has two guides on either side of the clips.

Dismounting the monitor

a

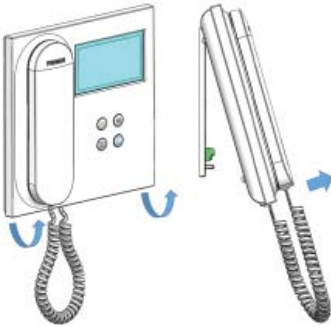

a) Wall installation

The connector is designed to dismount the monitor without the need for any tools. To do this, simply pull at the lower corners perpendicularly to the wall until the clips are unlocked and a minimum angle of 10 degrees with the wall is reached. Then, unhook the monitor from the hooks at the top of the connector.

b



b) Monitor attached to connector

If the monitor is attached to the connector but the connector is not anchored to a wall, you will need to use a flat-head screwdriver to prise them apart as shown.

CONNECTIONS

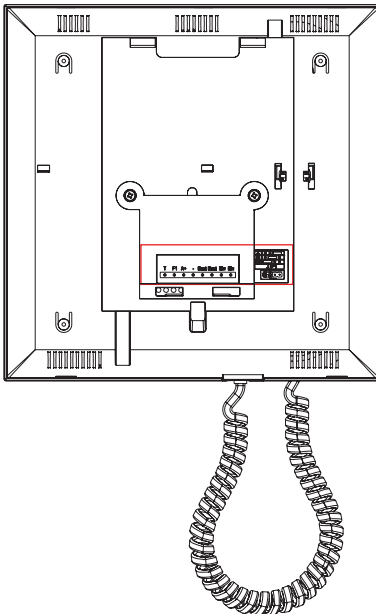

Monitor Connectors:

Bin,Bin: Data, audio and video input.

Bout,Bout: Data, audio and video input (*cascade connection*).

T, -: Apartment door call button (*P1*).

A+, -: Option of connection with the following devices:

- Call extender ref. 2040.
- Light and buzzer commander ref. 2438.

F1: Additional function. (*Negative output “-” / command transmission, see chapter **Buttons: Auxiliary function F1***).

JP1: Integrated line adapter bridge

- Top: Adaptation type A.
- Centre: Adaptation type C.
- Bottom: Without line adaptation: OFF, (by default).

DISTRIBUTION

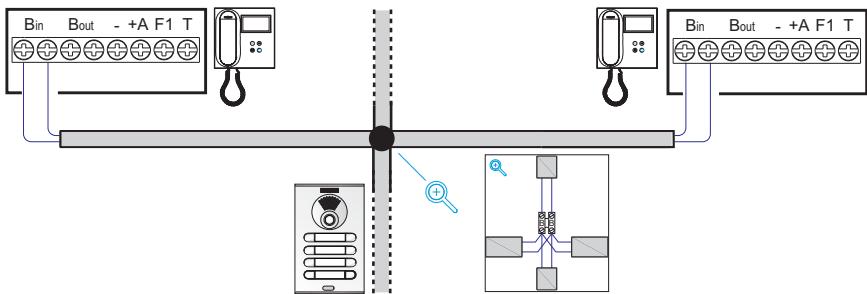

CASCADED

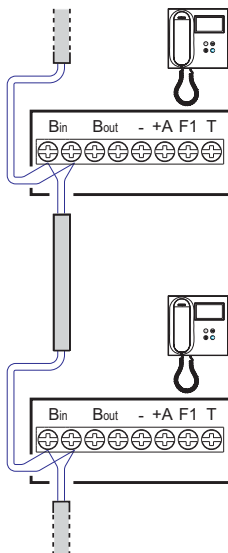

EXTENSIONS:

- Call extender: Ref. 2040
- Doorbell: P1

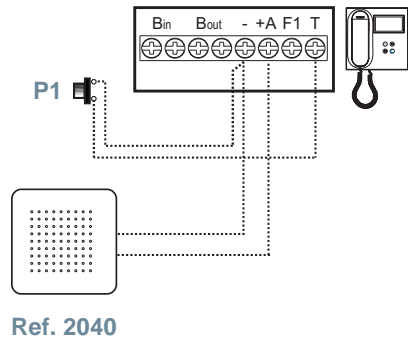

EXTENSIONS: Light and buzzer activator Ref. 2438

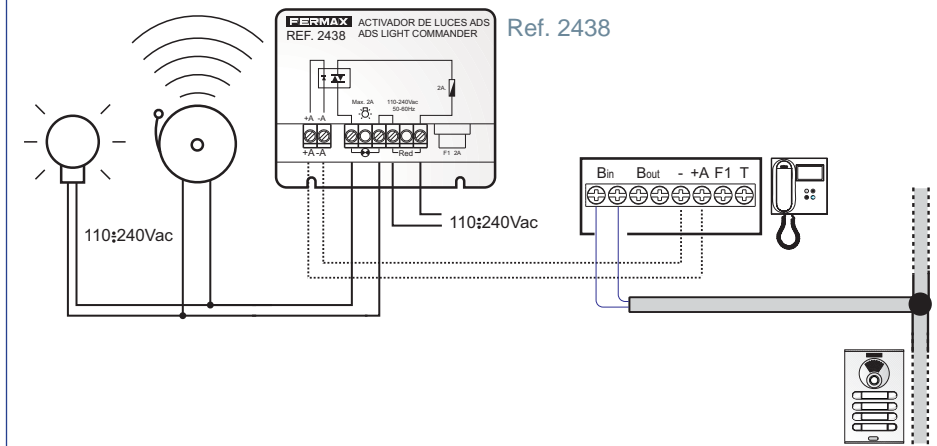

TECHNICAL SPECIFICATIONS

Power supply (without polarity)	18- 24 Vdc
Consumption	
Standby consumption	0.8 W
Maximum consumption	5.2 W
Number of terminals per home	3
Address of each monitor: 6 digits	000001...999999
Operating temperature	[-5° , +40°C] / [23° , 104°F]
Humidity	[0% - 90%]
OSD Screen	TFT 4.3"
Resolution	
Horizontal:	480 Line TV
Vertical:	272 Line TV
Monitor dimensions (H x W x D)	200 x 200 x 46mm - 8" x 8" x 1.8"

Please note: This VEO monitor is compatible with VEO and VEO XS monitors with versions V2.x and V3.x.

If any of the indicated versions of monitors are replaced, the monitor connector must also be changed. The current monitor connector has the reference 9447.

PRODUCT DESCRIPTION

VEO Monitor:

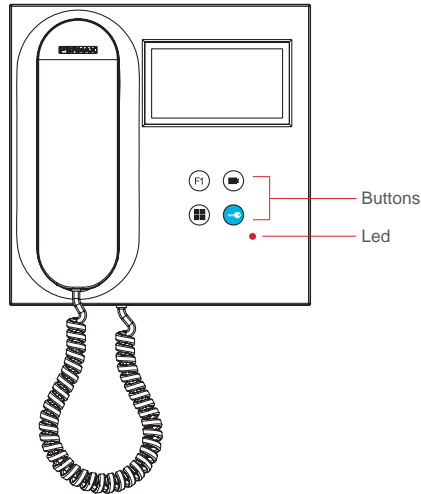

BUTTONS



Button for lock release / calls to the concierge.

- When you are in communication with the Outdoor Panel (*audio only or video only or audio+video*), pressing this button activates the lock release.
- With the arm hanging up (*monitor idle*), pressing this button makes a call to the concierge (if there is a concierge and the monitor is in Day Mode or Mixed Mode).



Auto-On button.

Connection via block camera or General Entrance camera (*feature available depending on the type of installation, see Chapter Operation: Auto-on*).



Auxiliary Function F1.

Auxiliary Function (negative output "-" / command transmission).

Negative transmission: *Negative output is emitted by terminal F1 when the F1 button is pressed, which also sends an F1 activation command in order to activate an auxiliary device.*



Menu Button.

- To access:
 - **Programming Menu**, it is accessed when the monitor is not programmed. From this menu, you can program the monitor according to your installation needs.
 - **User Menu**, (once the monitor is programmed). From this menu, you can access the user settings and customise them as you wish.

LED

● Red LED:

Intermittent fast blinking. Monitor not programmed.

Intermittent slow blinking. Indicates that the Do Not Disturb feature is enabled. Switched on. Monitor is idle.

Induction Loop



INDUCTION LOOP Identified with this label (*depending on model*). A version of the VEO monitor with an inductive loop on the monitor receiver is available. [See 97507 Telephone Receiver Inductive Loop on www.fermax.com](http://www.fermax.com).

- Includes an induction loop that works with devices worn by people with hearing disabilities.

Note: In hearing aids with manual mode selection, the Digital Mode must be set.



PROGRAMMING:

1. PROGRAMMING: ACCESS ADMINISTRATOR AND USER MENU

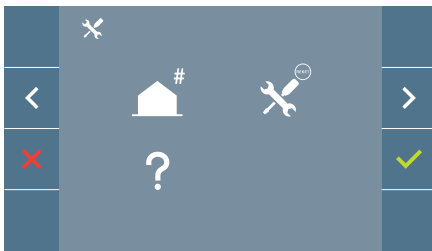

Screen: ADMINISTRATOR menu

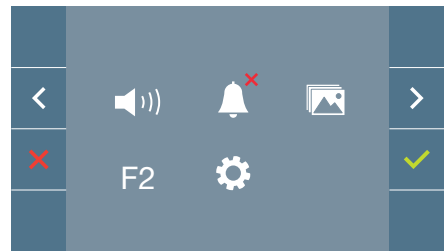

Screen: USER Menu

Do Not Disturb icons (*Screen: User Menu*) and Image Capture (*User Menu Screen. User Settings option*) will change depending on whether they are enabled/disabled. If they are enabled, a green tick will be displayed ✓ in the top right-hand corner of the icon, whereas if it is disabled you will see a red cross ✗.

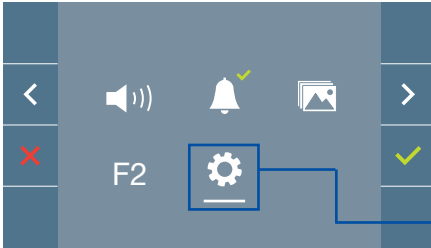

Screen: **USER Menu**

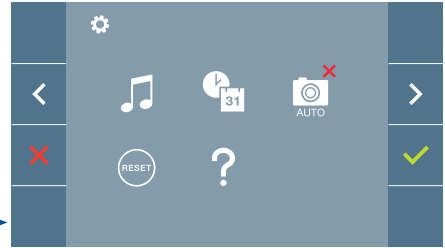

Screen: **User Settings option on the User Menu.**

Press the  **MENU** button to directly access:

- the Administrator Menu Monitor Programming option, if the monitor is not programmed.
- the User Menu screen, if the monitor is programmed.

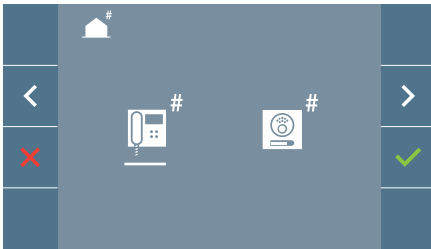

Screen: **Monitor Programming option on the ADMINISTRATOR Menu.**

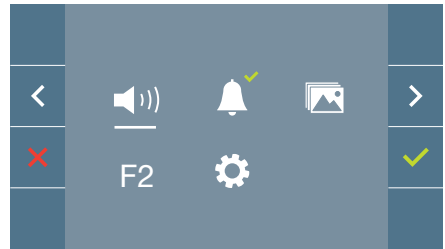

Screen: **USER Menu**

To access the Administrator Menu when the monitor is programmed, two steps must be performed:

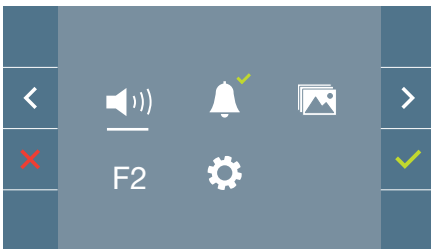

1. Press the  **MENU** button to access the **User Menu**.



2. Whilst on the User Menu, press the following buttons simultaneously:



2. PROGRAMMING: NAVIGATION BUTTONS AND MONITOR PUSH-BUTTONS

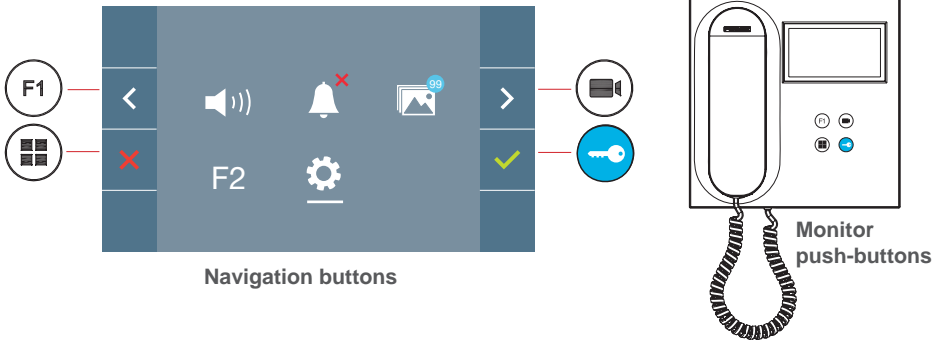

The icons displayed on the screen (*navigation buttons*: , , and), are controlled via the corresponding push-buttons located on the monitor:

- : Return to the previous screen or stand-by.
- : Select the previous option from the menu.
- : Highlight the next option on the menu.
- : Confirm the selection and activate the function.

Notes:

- The white line at the bottom of the icon indicates the function that is currently in effect. This may be selected by pressing.
- The monitor exits the programming dialogue automatically after 60 seconds of inactivity.

3. PROGRAMMING: ADMINISTRATOR MENU Screen

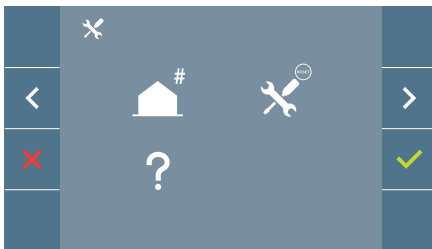

There are several options:

1. Monitor address programming.
2. Reset settings.
3. About.

3.1 ADMINISTRATOR MENU: Monitor address PROGRAMMING

The monitor will not function if it has not been programmed!

Note: A red LED, blinking slowly, indicates that the monitor is not programmed - once the monitor address is programmed, the red LED will turn off.

There are three options for programming the monitor from:

- A) From the Monitor.
- B) From the Panel
- C) From the Doorbell.

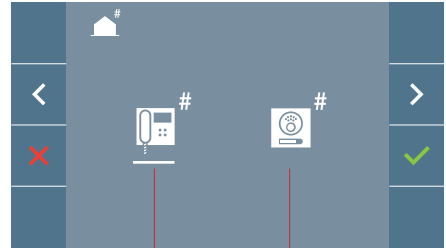
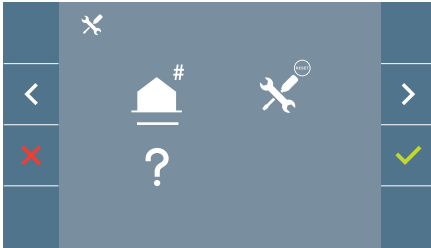

From Monitor From Panel

A) From the Monitor.

It is possible to program the monitor using the on-screen menu.

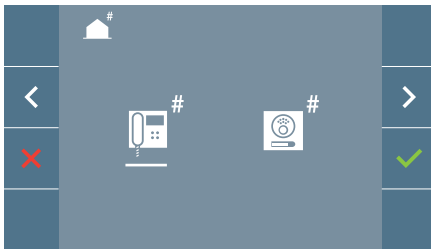

Programming the call number: Press on the screen and access the screen to program the dwelling number (*numbers from right to left*).

Each time you press , the number increases (*starting at 1*) and the **arrow** is used for scrolling. A white cursor indicates the entry position of the digit. Programme the corresponding number and accept it using . Once the monitor address has been programmed, this will be indicated by a continually lit red LED.

B) From the Panel

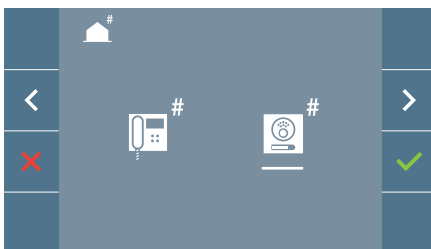

Option selected by the white line below the icon. Pressing this will cause a beep to be heard on the monitor.

The monitor is automatically connected to the outdoor panel by activating the camera. Enter the calling code for that monitor from the panel. Depending on the type of panel installed:

- By pressing the corresponding button
- By entering the code + bell.

Notes:

- *The period between the monitor programming entry confirmation beep and the call from the panel to program the monitor address must be less than 2 and a half minutes.*
- *The panel from which the programming takes place must be designated as the master panel.*

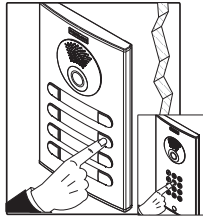
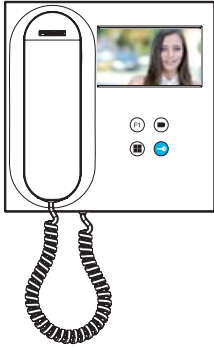

A different ring tone is produced, confirming the programming of the monitor, and the camera image continues to be displayed. After a few seconds, the monitor will return to the rest position. Once the monitor address has been programmed, this will be indicated by a continually lit red LED.

C) From the Doorbell.

The monitor address can also be programmed - via the entrance doorbell . For this type of operation, the monitor must not be previously programmed. Press and hold the doorbell for 5 seconds, and you will hear a beep confirming access to the monitor's programming mode.

The monitor is automatically connected to the outdoor panel by activating the camera. Enter the calling code for that monitor from the panel, depending on the type of panel installed:

- By pressing the corresponding button.
- By entering the code + bell.

A different ring tone is produced, confirming the programming of the monitor, and the camera image continues to be displayed. After a few seconds, the monitor will return to the rest position. Once the monitor address has been programmed, this will be indicated by a continually lit red LED.

Notes:

- *The period between the monitor programming entry confirmation beep and the call from the panel to program the monitor address must be less than 2 and a half minutes.*
- *The panel from which the programming takes place must be designated as the master panel.*

3.2 ADMINISTRATOR MENU: **RESET SETTINGS**

The installer can reset the monitor parameters to the default settings, by selecting and confirming the appropriate option.

The reset affects both the user's configuration parameters and the monitor address.

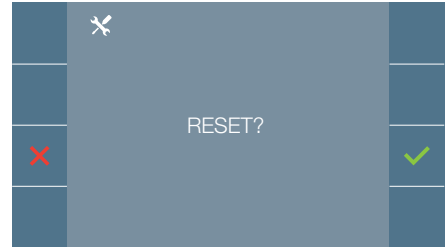

Note: A red LED, blinking slowly, indicates that the monitor is not programmed. As the reset process erases the programmed monitor address, when the LED is flashing it will indicate that the reset is finished.

3.3 ADMINISTRATOR MENU: **ABOUT**

A QR code is displayed on the screen that allows access to the complete monitor documentation.



4. PROGRAMMING: **USER MENU** Screen

Pressing the MENU  button directly accesses the User Menu screen if the monitor is programmed.

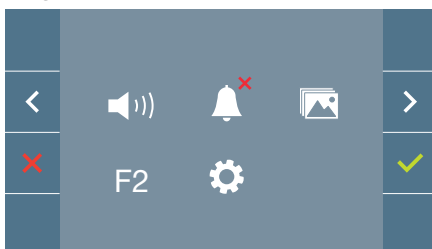

- There are several options:
1. Monitor volume settings.
 2. Do Not Disturb function
 3. Display images
 4. F2 Function
 5. User parameter settings

4.1 USER MENU: MONITOR VOLUME SETTINGS

It is possible to adjust the volume of the ringtone within a range of ten possible values.

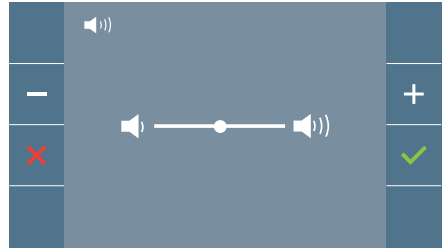
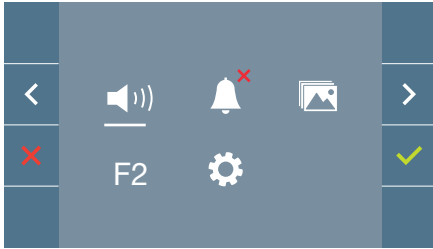

Firstly, the current volume is displayed and can be increased (+) or decreased (-) with the corresponding buttons. These will allow you to achieve your desired settings.

4.2 USER MENU: DO NOT DISTURB MODE

This icon allows you to enable/disable the Dial Tone (*Do Not Disturb*).

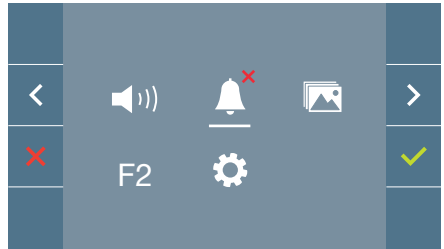
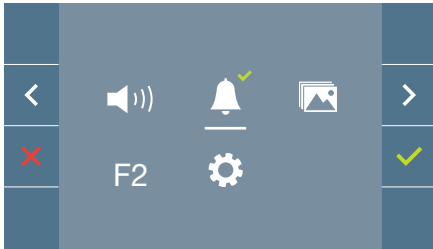

Press the icon  to change the selection. By default normal operation is selected (*The call is heard*).

The red LED on the monitor blinks slowly when the Do Not Disturb mode is active.

4.3 USER MENU: DISPLAY IMAGES

This icon allows you to view images that have been automatically captured and delete them. For more information [see Chapter on Operation: Image Display](#).

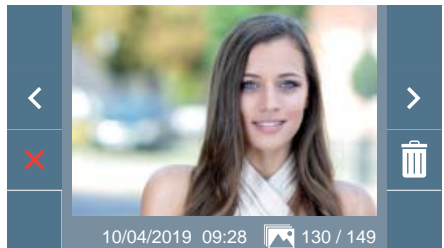
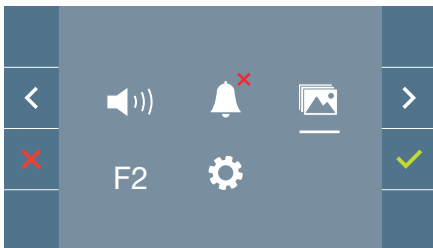

4.4 USER MENU: F2 FUNCTION

The F2 function sends an activation command to activate an auxiliary device.

An on-screen notification of the action will be shown: F2 ON for 3 seconds. This function is contained in the main screen of the user menu.

The F2 command is sent by the bus, including the monitor address, to activate the auxiliary devices connected to the bus, such as for example a duox relay, (*check with your installer*).

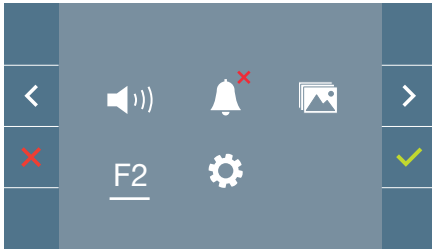

4.5 USER MENU: USER PARAMETER SETTINGS

Within the user menu, selecting the option "User parameter settings" will access a new screen corresponding to the various configuration parameters:

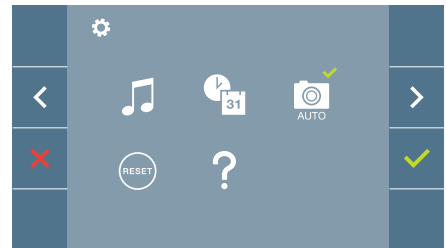
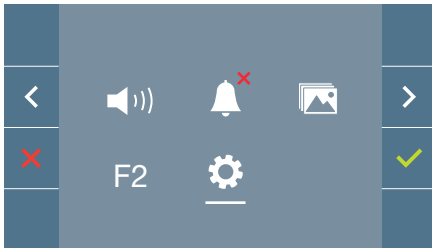

The parameters are the following:

1. Melody selection
2. Date and time settings
3. Enable/disable image capture
4. Reset the configuration parameters
5. User help

4.5.1 User parameter settings: MELODY SELECTION

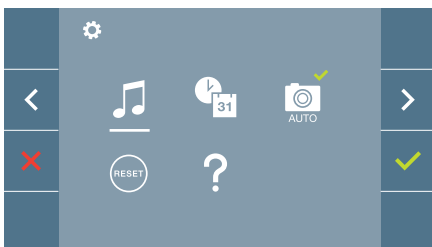

The monitor allows you to select a separate melody for the panels and another for the concierge. The panels are:

- Panel 0, monitor block.
- Panel 1, monitor block.
- Panel 0, General Entrance.

You may assign up to 5 different melodies.

a) Panel melody selection

Panel 0, monitor block

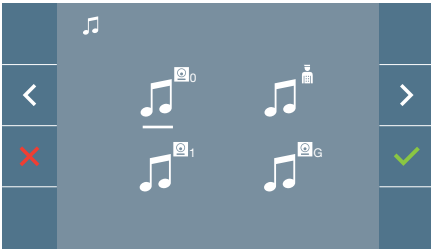

By selecting this option you can change the melody that you hear on the monitor when a call is made from the outdoor Panel 0 of the monitor block.

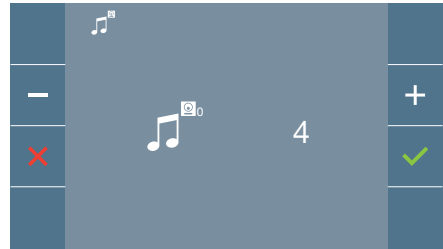

Once you have selected the option, you will see and hear the current melody, and by pressing the + o - button you can continue selecting and listening to the various melodies available on the monitor.

Panel 1, monitor block

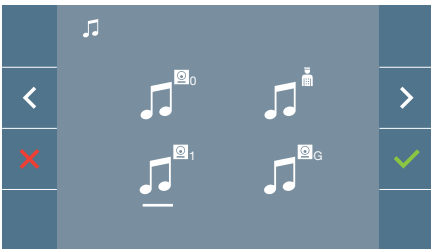

By selecting this option you can change the melody that you hear on the monitor when a call is made from the outdoor Panel 1 of the monitor block.

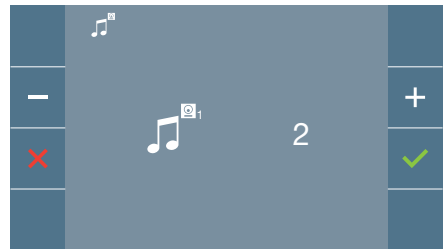

Once you have selected the option, you will see and hear the current melody, and by pressing the + o - button you can continue selecting and listening to the various melodies available on the monitor.

Panel 0, General Entrance

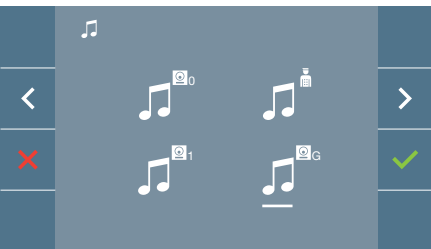

By selecting this option you can change the melody that you hear on the monitor when a call is made from the outdoor Panel 0 of the general entry.

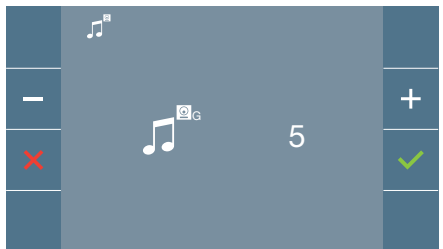

Once you have selected the option, you will see and hear the current melody, and by pressing the + o - button you can continue selecting and listening to the various melodies available on the monitor.

b) Concierge melody selection

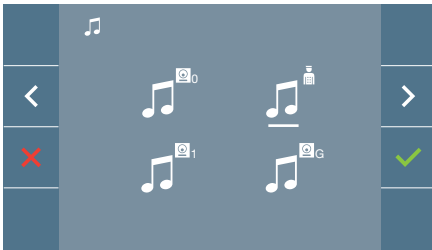

By selecting this option you can change the melody that you hear on the monitor when the concierge calls that monitor.

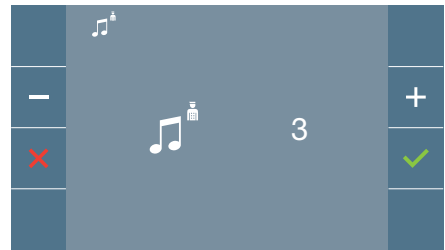

Once you have selected the option, you will see and hear the current melody, and by pressing the + or - button you can continue selecting and listening to the various melodies available on the monitor.

4.5.2 User parameter settings: DATE AND TIME SETTINGS

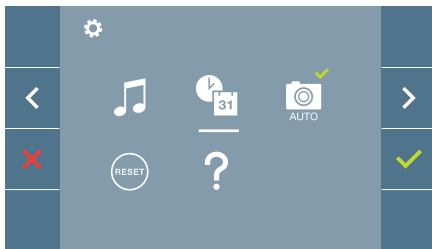



The monitor allows you to adjust the date and time.

Via the navigation icons, you can change the date and time settings and browse the same. Press the icon ✓ to confirm the selection.

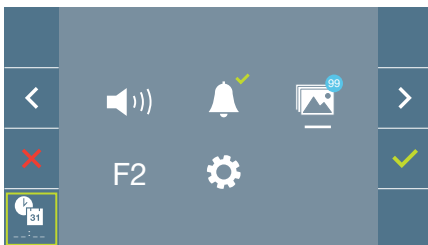
If the power supply is cut off for any reason, the date and time settings will reset to the default configuration (01/01/2019). An icon will appear on the user menu and on the video display warning that the date is incorrect.



Notes:

- You are not permitted to validate an incorrect date and time, and the closest date and time will be suggested.
- Holding down the navigation icons  -  will cause the numbers to change more quickly.

4.5.3 User parameter settings: **ENABLE/DISABLE IMAGE CAPTURE**

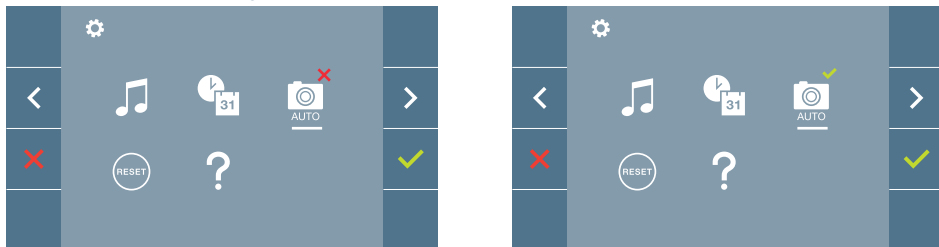

With this option, you can enable or disable the automatic capture of images. Select the image capture icon and press confirm  to activate or deactivate it.

The monitor can take an automatic picture within 3 seconds of receiving a call from an outdoor panel. According to the European Union legislation about data protection ((EU) 2016/679), the capture of images may be restricted. This feature is deactivated by default in all monitors, although can be activated at your own responsibility.

Furthermore, the legislation may force to place a sign next to door stations, indicating that monitors can capture images. You can download it at <https://www.fermax.com/intl/en/corporate/utilities.html>.

4.5.4 User parameter settings: **USER RESET**

With this option you can reset all settings to factory default values, keeping the address already programmed into the monitor. Selecting and confirming the option.

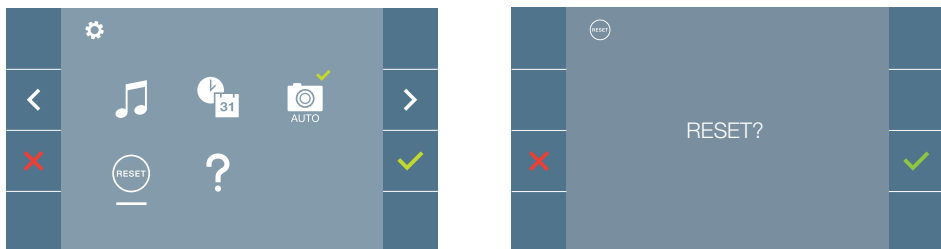

If you want to perform a reset, confirm the option.

4.5.5 User parameter settings: **HELP**

The screen will display a QR code that allows access to a promotional link that explains in detail the digital DUOX system that Fermax has created.

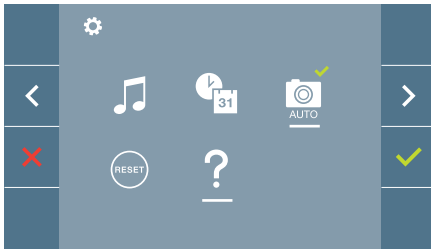

5. SETTINGS: VIDEO AND AUDIO

5.1 SETTINGS: VIDEO SETTINGS: BRIGHTNESS - CONTRAST - COLOUR

The monitor allows you to adjust the brightness, contrast and colour while a call is incoming (*communication not established*) or when auto-on is in progress (camera). [See Chapter Operation: Auto-on.](#)

While the video image is on the screen, you may press the button briefly (Menu) (⊞) to display a shortcut menu allowing adjustments to the brightness, contrast, and colour of the image.

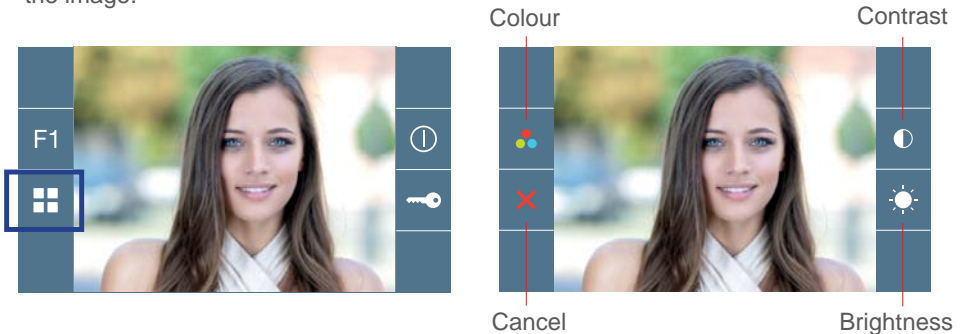

1. Select the contrast, brightness and colour with the corresponding buttons.

The audio can also be activated from these screens (*establish communication*).

Note: You will have 30 seconds to change the Video Settings, and when this time is up the monitor will return to idle mode.

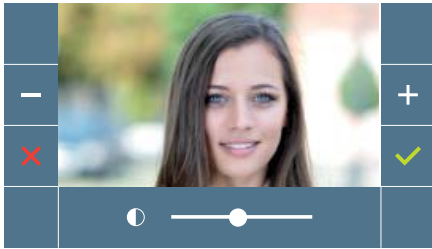

Contrast

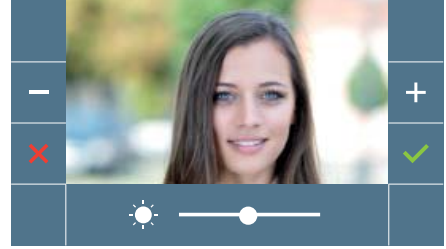

Brightness

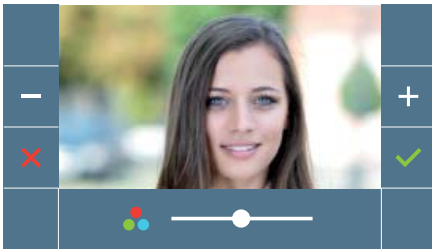

Colour

5.2 SETTINGS: AUDIO SETTINGS

While it is open, the audio channel can be used to adjust the volume of the audio. To make audio adjustments, press the button  (*menu*) and a shortcut menu for that setting will be displayed.

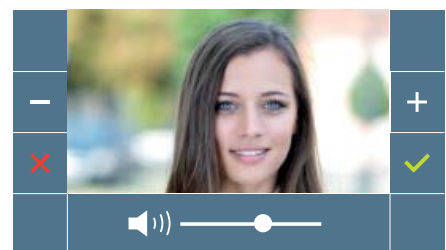

 User Manual: FUNCTIONING



FUNCTIONING

1. FUNCTIONING: ANSWERING A CALL. Receiving a call.

When you press the call button on the **Outdoor Panel**, a calling tone will be made on that panel and on the monitor, and the screen will switch on. When you receive a call, you have 30 seconds to answer before the device returns to idle. During this time, the red LED will turn off to indicate that you have a call waiting.

You may unhook the receiver and hold a conversation with the outdoor panel. Communication will end automatically after 90 seconds, or whenever the button is pressed.

Notes:

- If there are several monitors / telephones in the same dwelling, only the first to pick up will receive audio, with the other monitors / telephones returning to idle mode. Trying to pick up any of them will result in a 'line busy' tone.
- If communication is not established (by unhooking the receiver) with the outdoor panel, the monitor will switch off automatically after 30 seconds.

When you receive a call from the outdoor panel, it is possible to open the door at any time by pressing and holding the button .

1.1 Video call.

Should the apartment receive a call from a video panel, the monitor will display the video captured by the camera in the outdoor panel.

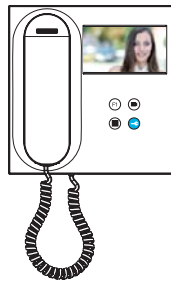

1.2 Audio call.

Should the apartment receive a call from an audio panel, the monitor will display the following screen:

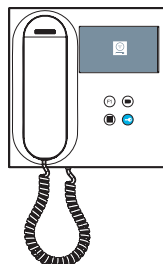

1.3 Calls to concierge.

If a monitor is configured in MIXED or DAY mode, pressing the door lock button while it is on standby will initiate a call to the last guard unit that configured it in this mode. The monitor screen will display the following image and a ringing tone will sound.

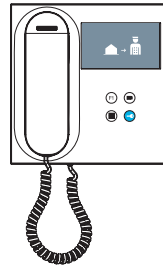
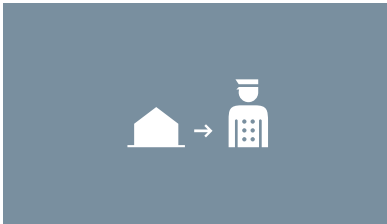

If you receive a call from the concierge on the indoor monitor, the following image will be displayed:

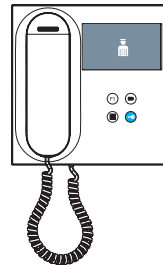

2. OPERATION: ACTIVATING THE MONITOR MANUALLY (AUTO-ON)

With the monitor on standby, press the  (camera) button to turn the monitor on manually.

The total timings for preview without audio (30 seconds) and conversation (90 seconds) stay the same, even if you change cameras.

Auto-on on standby:

1. If the previous call from the panel ended less than 15 seconds ago, the panel will be called again: **R.**



2. If the previous point does not occur, auto-on begins with the different panels visible on the monitor.

Press panel 0, panel 1, general panel in sequence (depending on the availability of panels).

- 1 Panel 0 or camera 0 of the monitor block.
- 2 Panel 1 or camera 1 of the monitor block.
- 3 Panel 0 or camera 0 of the General Entrance.

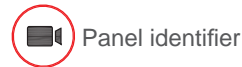

Once communication with a panel is established, you can change it by pressing the  button (camera).

Auto-on during incoming call:

1. If the call corresponds to a panel in the sequence described in the previous point, the auto-on will begin for the next panel in the sequence.
2. If the call is NOT from a panel, auto-on will begin with block panel 0, (depending on panel availability), and follow the sequence:



1 Panel 0 or camera 0 of the monitor block



2 Panel 1 or camera 1 of the monitor block



- 3 Panel 0 or camera 0 of the General Entrance

Notes:

- Auto-on only works with suitable panels. If you are unable to effect auto-on, please consult your installer. If it is unable to connect to any of the three possible panels, the monitor will issue an error tone and return to its idle state.
- Once a conversation with a panel is over, pressing the auto-on button within the following 15 seconds will reconnect you to that panel.
- In the case of auto-on without audio, if the door is opened within 5 seconds, the call will end.
- Various cases of a second monitor performing an auto-on can be distinguished:
 - o The first monitor is in auto-on mode, and has not established a conversation with audio: in this case, the second monitor cannot perform an auto-on.
 - o The first monitor has performed an auto-on and has established an audio conversation: the auto-on can begin.
 - o In any case, when the first monitor's conversation or auto-on with video only ends, the second monitor may perform an auto-on.

3. FUNCTIONING: IMAGE DISPLAY

Function allowing you to see all images captured. The image capture function must be pre-selected. [See chapter 4.5 User Menu - 4.5.3 Activation/Deactivation of images.](#)

When a call is made from the outdoor panel, (the image capture function must be pre-selected), a photo is automatically taken 3 seconds later and stored in the memory.

Note: The maximum number of images that can be stored is 150, if a new image is stored while the memory is full, the oldest image will be erased.

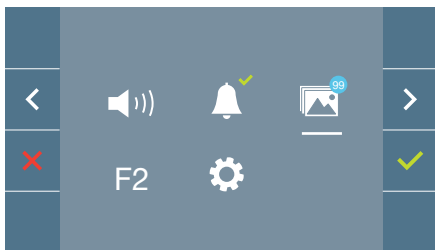

Select the icon  to display the various photos taken.

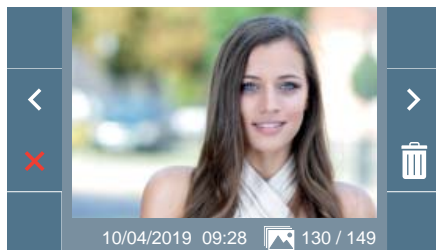

The most recent image will be displayed with the date, time and the photo number.

A contextual menu will appear:



: To select/view the photos stored.





: To clear images.

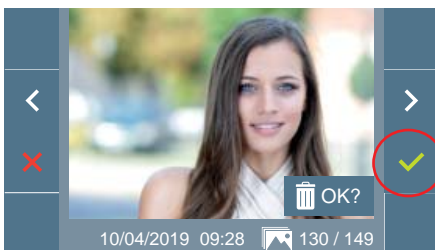

: To cancel and go to the previous screen.



If you press the Erase option  you will be taken to the delete confirmation screen, and by pressing the confirmation icon  the selected picture will be deleted. The user can navigate through the saved photos, even when the confirmation window is active.

Note: If you press the confirm icon  for 5 seconds, all images can be deleted upon confirmation.

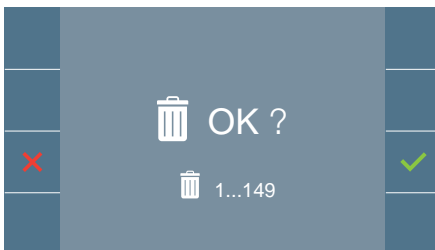

If there are image captures that have not been displayed by the user, notifications will appear on the user menu icon and on the video screen.

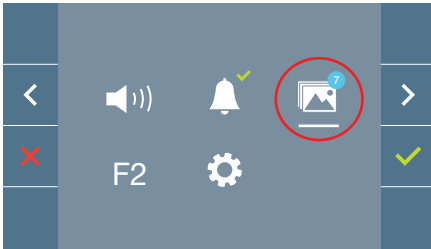

The image display icon changes, showing a blue circle with the number of images that may be displayed (maximum 99). The circle will deduct the number of images displayed by the user.



When a call is made, you will be informed that there are unviewed photos, although how many will not be specified.

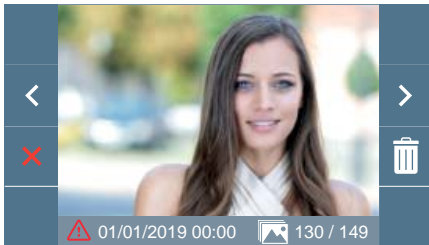

If the power supply is cut off for any reason, the date and time settings will reset to the default configuration (01/01/2019).

If an image is captured without setting the date and time first, this icon appears when the image is displayed,  indicating that the date and time settings that appear next to the image are not correct.



The device you have purchased is identified under Directive 2012/19/EU on waste electrical and electronic equipment. More info:





VOUS DISPOSEZ D'UN PRODUIT DE QUALITÉ. FÉLICITATIONS !
Fermax électronique développe et fabrique des appareils de prestige respectant les normes de conception et de technologie les plus élevées.
Nous espérons que vous profiterez de ses fonctionnalités.

Publication technique à caractère informatif édité par FERMAX ELECTRÓNICA S.A.U.

FERMAX ELECTRÓNICA, dans sa politique d'amélioration constante, se réserve le droit de modifier le contenu de ce document ainsi que les caractéristiques des produits concernés à tout moment et sans préavis. Toute modification sera prise en compte dans les éditions ultérieures à ce document.







Ce produit est protégé par les brevets et modèles d'utilité suivants:

BREVETS: US 9215410, US 9762852, BE1023440, AU2014203706.

MODÈLES UTILITAIRES: ES1187384U, ES1141495U, FR3038192, DE202016000632U1, CN205987229(U)..

Cod. 970159 V04_19

TABLE DES MATIÈRES

	INTRODUCTION	4
	INSTALLATION	5
	-Installation du moniteur	5
	-Connexions	6
	CARACTÉRISTIQUES TECHNIQUES	8
	DESCRIPTION DU PRODUIT	9
	-Boutons	9
	- Led	10
	-Boucle inductive	10
	PROGRAMMATION	10
	1. Accéder au menu de l'administrateur et de l'utilisateur	10
	2. Boutons de navigation et boutons-poussoirs	12
	3. Menu administrateur	12
	1. Programmation de l'adresse du moniteur	12
	2. Réinitialisation des paramètres	15
	3. À propos	15
	4. Menu utilisateur	15
	1. Réglage du volume	16
	2. Fonction ne pas déranger	16
	3. Visualiser les images	16
	4. Fonction F2	17
	5. Réglages des paramètres d'utilisateur	17
	5. Réglages de vidéo et audio	21
	FONCTIONNEMENT	23
	1. Répondre à un appel	24
	2. Déclenchement manuel du moniteur (Autoallumage)	25
	3. Visualisation des images	27



INTRODUCTION

Le moniteur VEO DUOX incorpore la technologie DUOX de l'audio et la vidéo, l'alimentation et les données par le biais de deux fils non polarisés.

Les caractéristiques fondamentales du système DUOX sont les suivantes :

- Alimentation des moniteurs par l'intermédiaire du bus de 18Vdc / 24 Vdc.
- Secret de conversation.
- Bus non polarisé.

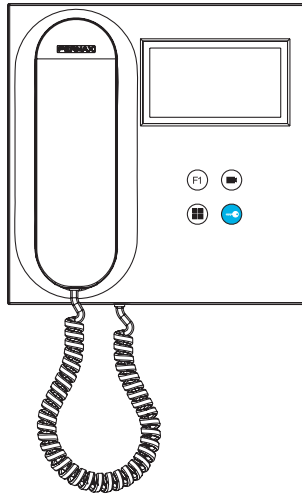

FONCTIONNALITÉS

Les fonctions disponibles dans le moniteur VEO DUOX sont résumés dans la liste suivante :

- Ouverture de la porte.
- Appel à la Conciergerie.
- Réglage du volume d'appel.
- Déconnexion d'appel (Ne pas déranger).
- Sélection des mélodies.
- Sonnette de porte.
- Programmation depuis la platine, le moniteur et la sonnette de la porte.
- Réglage du volume audio.
- Configuration des paramètres par le menu à l'écran (OSD).
- Réglage de brillance, contraste et couleur.
- Fonctions auxiliaires F1 et F2.
- Boucle inductive (*selon le modèle*).
- Capture d'images (*avec mémoire*).



INSTALLATION

INSTALLATION MONITEUR

Connecteur

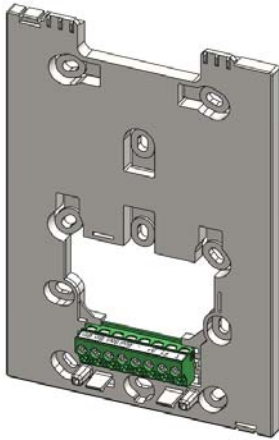

Câblage de surface

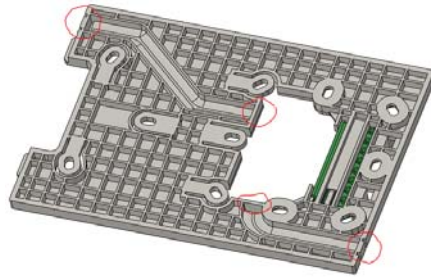

Pour les installations non encastrées, le connecteur dispose de deux canaux pour guider les câbles vers la barrette de raccordement depuis le sol ou le plafond. Deux des cloisons marquées doivent être enlevées à l'aide d'une pince coupante pour permettre l'accès aux câbles par le bas ou le haut du connecteur.

Montage du moniteur

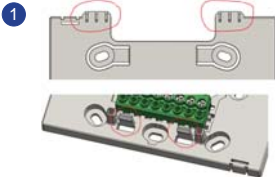

Le moniteur est suspendu aux deux crochets supérieurs du connecteur et maintenu à celui-ci par deux clips situés dans la zone inférieure.

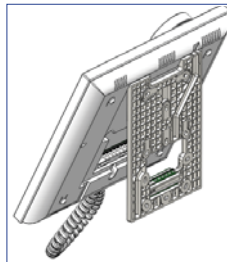

La figure suivante montre le moniteur lors de l'accrochage sur le connecteur avant de le rabattre vers le bas pour terminer l'assemblage.

Placer le moniteur en face du connecteur à un angle compris entre 15 et 30 degrés, en l'accrochant aux crochets mentionnés ci-dessus. Rabattre le moniteur sur le connecteur en exerçant une pression vers le mur sur les deux côtés de l'extrémité inférieure jusqu'à ce que vous entendiez ou remarquez que les clips inférieurs soient verrouillés.



Pour positionner le moniteur et renforcer le maintien, le connecteur est muni de deux guides situés de chaque côté des clips.

Démontage du moniteur

a

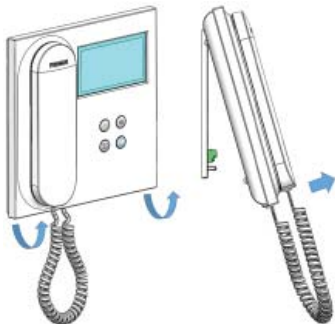

a) Installé sur le mur

Le connecteur est conçu pour retirer le moniteur sans avoir besoin d'outils. Pour ce faire, il suffit de tirer les coins inférieurs perpendiculairement au mur jusqu'à ce que les clips soient déverrouillés et qu'un angle d'au moins 10 degrés par rapport au mur soit atteint. Débranchez ensuite le moniteur des crochets supérieurs du connecteur.

b

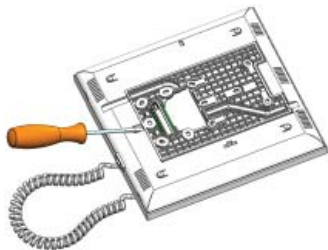

b) Moniteur et connecteur assemblés

Si le moniteur et le connecteur sont assemblés, sans que ce dernier ne soit fixé à un mur, il est nécessaire d'utiliser un tournevis plat comme un levier pour les séparer comme indiqué.

CONNEXIONS

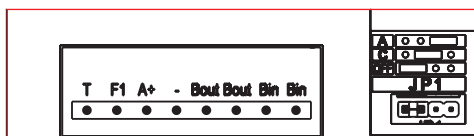
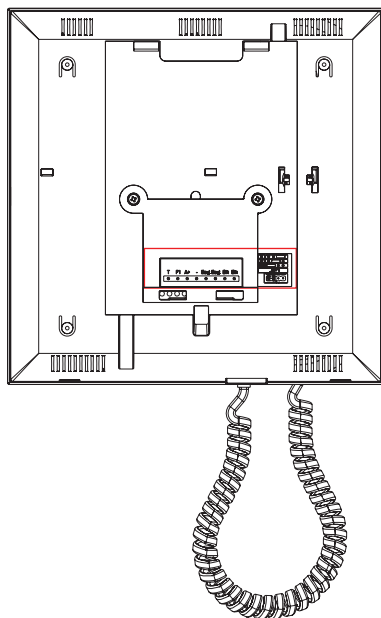

Connecteurs Écran :

Bin,Bin : Données, audio et vidéo entrée.

Bout,Bout : Données, audio et vidéo entrée (*connexion en cascade*).

T, - : Boutons-poussoirs d'appel porte logement (P1).

A+, - : Possibilité connexion aux équipements suivants :

- Prolongateur d'appel réf. 2040.
- Activateur de Lumières et sonnettes réf. 2438.

F1 : Fonction supplémentaire. (*Sortie négatif "-" / envoi des instructions voir chapitre*

Boutons : Fonction auxiliaire F1).

JP1 : Pont adaptateur de ligne intégré

- En haut : Adaptateur type A.
- Centre : Adaptateur type C.
- En bas : Sans adaptateur de ligne : OFF, (par défaut).

DISTRIBUTION

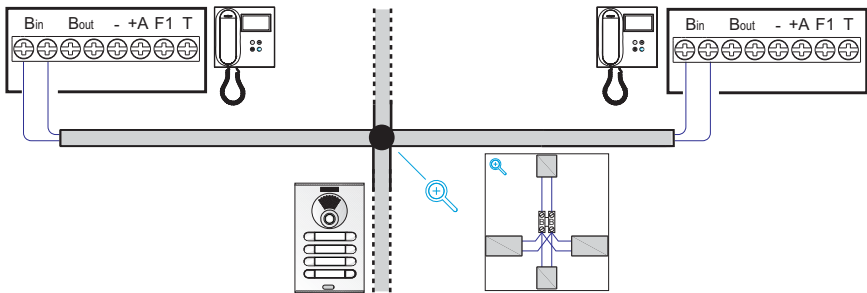

CASCADE

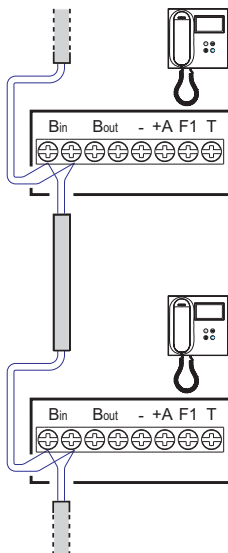

EXTENSIONS :

- Prolongateur d'appel : Réf. 2040
- Sonnette de porte : P1

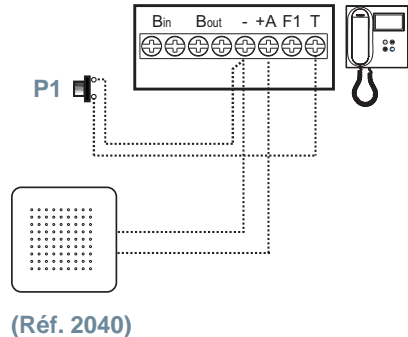

EXTENSIONS : • Activateur de Lumières et sonnettes Réf. 2438

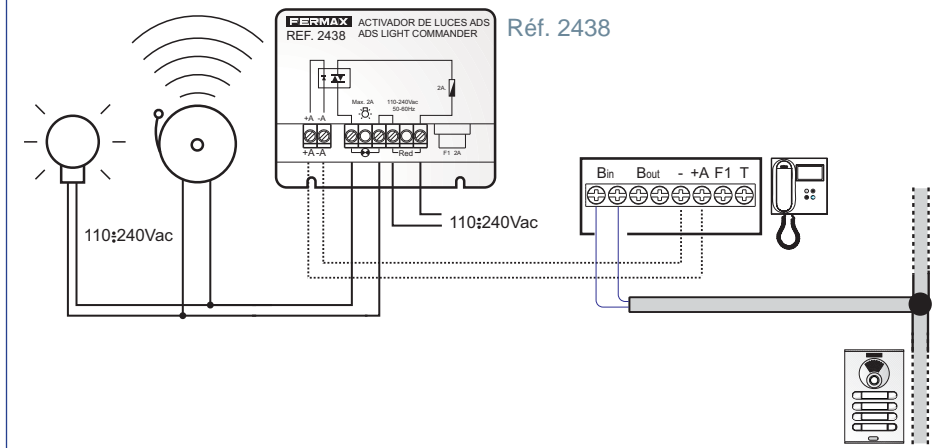

CARACTÉRISTIQUES TECHNIQUES :

Alimentation (sans polarité)	18 - 24 Vdc
Consommation	
Consommation en Stand by	0,8 W
Consommation maximale	5,2 W
Nombre de terminaux par logement	3
Adresse de chaque moniteur : 6 chiffres	000001...999999
Température de fonctionnement	[-5° , +40°C] / [23° , 104°F]
Humidité	[0% - 90%]
Écran OSD	TFT 4.3"
Résolution	
Horizontale :	480 Line TV
Verticale :	272 Line TV
Dimensions moniteur (Hauteur x Largeur x Profondeur)	200 x 200 x 46mm - 8" x 8" x 1.8"

Remarque importante : Ce moniteur VEO est compatible avec les moniteurs VEO et VEO XS avec les versions V2.x et V3.x.

Si l'un des moniteurs des versions indiquées est remplacé, il faudra aussi remplacer le connecteur du moniteur. Le connecteur du moniteur actuel a la référence 9447.

DESCRIPTION DU PRODUIT

Moniteur VEO

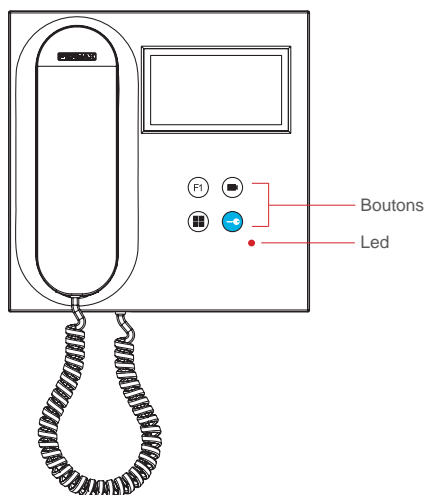

BOUTONS



Bouton d'ouvre-porte / appel à la conciergerie.

- Est en communication avec la Platine de rue (*seulement audio ou seulement vidéo ou audio + vidéo*), en appuyant sur le bouton, l'ouvre-porte s'active.
- Avec le combiné raccroché (*moniteur en mode inactif*), en appuyant sur ce bouton, un appel au concierge est réalisé (s'il y a une conciergerie et que le moniteur est en mode jour ou mixte).



Bouton d'autoallumage.

Connexion avec la caméra du Bloc ou de l'Entrée Générale (*fonction disponible selon le type d'installation, voir chapitre **Fonctionnement : Autoallumage***).



Fonction auxiliaire F1

Fonction auxiliaire (sortie signe négatif "-" / envoi des instructions).

Envoi du signe négatif : *Sortie du signe négatif par la borne F1 en appuyant sur le bouton F1 et envoie aussi une instruction F1 d'activation afin de pouvoir activer un dispositif auxiliaire.*



Bouton Menu.

· Pour accéder à :

- **Menu de Programmation**, on y accède quand le moniteur n'est pas programmé. Depuis ce menu, on peut réaliser la programmation du moniteur selon les nécessités de l'installation.
- **Menu de l'Utilisateur**, (une fois le moniteur programmé). Depuis ce menu, on peut accéder aux réglages de l'utilisateur pour sa personnalisation.

LED

● Led Rouge :

Intermittente rapide. Moniteur non programmé.

Intermittente lente. Indique que la fonction ne pas déranger est activée.

Allumée. Moniteur inactif.

Boucle inductive

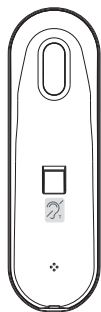

Boucle inductive. Elle est identifiée avec cette étiquette (*selon le modèle*). Il existe un modèle du moniteur VEO avec une boucle inductive sur le combiné du moniteur. [Voir 97507 Combiné Téléphone boucle inductive sur www.fermax.com](http://www.fermax.com).

- Comprend une boucle qui interagit avec les appareils d'audition des personnes ayant des problèmes auditifs.

Note : Sur des appareils d'audition avec une sélection manuelle de mode, le Mode Numérique doit être configuré.



PROGRAMMATION :

1. PROGRAMMATION : ACCÉDER AU MENU D'ADMINISTRATEUR ET D'UTILISATEUR



Écran : Menu ADMINISTRATEUR

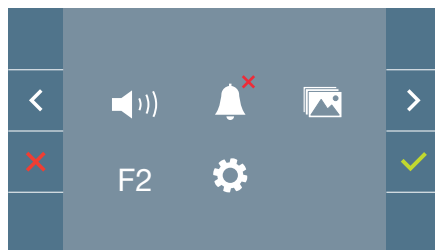

Écran : Menu UTILISATEUR

Les icônes de ne pas déranger (Écran : Menu Utilisateur) et Capture d'Image (Écran Menu Utilisateur. Option Paramètres de l'Utilisateur) changeront selon si elles sont activées/désactivées. Si elles sont activées, un tick vert apparaîtra ✓ sur la partie supérieure droite de l'icône, alors que si elles sont désactivées, une croix rouge apparaîtra ✗.

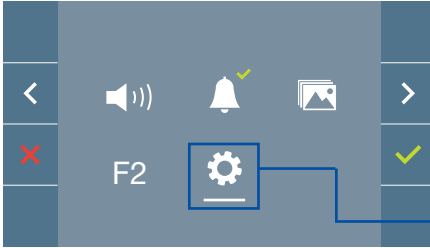

Écran : Menu UTILISATEUR

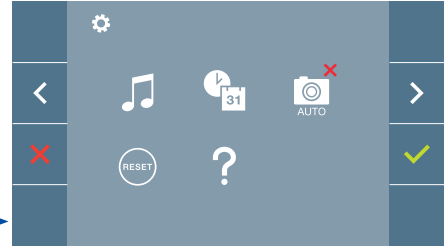

Écran : Option Paramètres de l'utilisateur du Menu UTILISATEUR.

En appuyant sur le bouton  **MENU**, on accède directement :

- À l'option de Programmation du moniteur du Menu d'Administrateur, si le moniteur n'est pas programmé.
- À l'écran du Menu de l'Utilisateur si le moniteur est programmé.

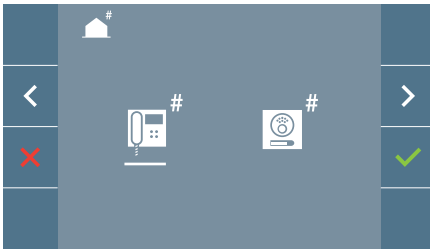

Écran : Option Programmation du moniteur du menu ADMINISTRATEUR.

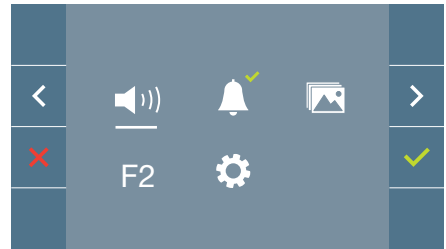

Écran : Menu UTILISATEUR

Pour accéder au Menu d'Administrateur lorsque le moniteur est programmé, les deux étapes suivantes doivent être réalisées :

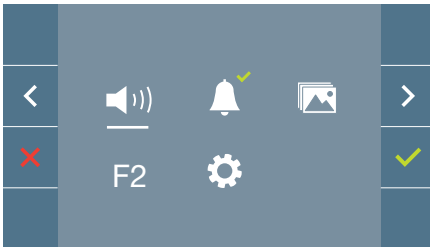

1. Appuyer sur le bouton  **MENU**, on accède à l'écran du **Menu de l'Utilisateur**.





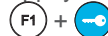



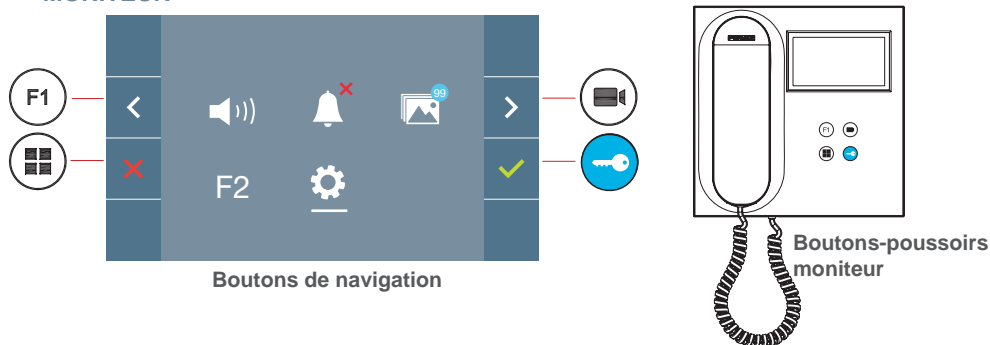

2. En étant sur l'écran du Menu de l'Utilisateur, appuyer simultanément sur les boutons :



2. PROGRAMMATION : BOUTONS DE NAVIGATION ET BOUTONS-POUSSOIRS DU MONITEUR



Les icônes visualisées sur l'écran (*boutons de navigation* : , ,  et ), sont manipulées avec les boutons-poussoirs correspondants placés sur le moniteur :

-  : Nous revenons à l'écran précédent ou stand-by.
-  : Nous sélectionnons l'option préalable du menu.
-  : Nous marquons l'option suivante du menu.
-  : Confirmez la sélection et activez la fonction.

Notes :

- La ligne blanche sous l'icône indique la fonction dans laquelle nous nous trouvons. Elle se sélectionne en appuyant dessus.
- Le moniteur sort de la programmation automatiquement, après 60 secondes d'inactivité.

3. PROGRAMMATION: Écran MENU ADMINISTRATEUR

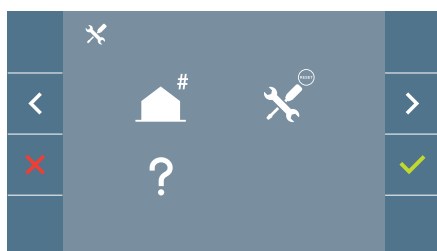

Il existe plusieurs options :

1. Programmation de l'adresse du Moniteur.
2. Réinitialisation des paramètres.
3. À propos de.

3.1 MENU ADMINISTRATEUR : PROGRAMMATION direction moniteur

Le moniteur ne fonctionnera pas s'il n'a pas été programmé !

Note : La led rouge clignotant lentement indique que le moniteur n'est pas programmé, alors qu'une fois son adresse programmée, la led rouge s'éteint.

Il existe trois options pour programmer le moniteur depuis :

- a) Depuis le moniteur.
- b) Depuis la platine.
- c) Depuis la sonnette de la porte.

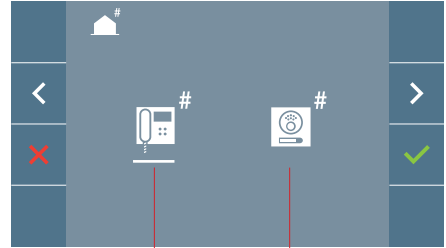



Depuis le moniteur Depuis la platine

a) Depuis le moniteur.

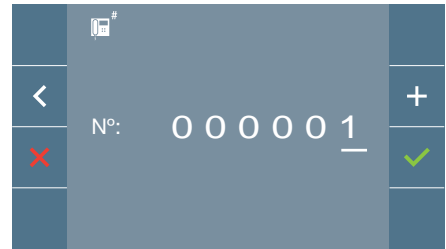
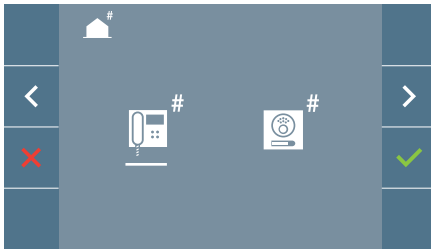
Il est possible de programmer le moniteur par le menu à l'écran.



Programmer le nombre d'appels : Appuyer sur  l'écran afin d'accéder à la programmation du nombre de logements (*nombres de droite à gauche*).

À chaque fois que l'on appuie sur  le nombre augmente (*en commençant par 1*) et la **flèche** est utilisée pour le déplacement. Un curseur blanc indique la position d'introduction du chiffre. Programmer le nombre correspondant et accepter avec . Une fois l'adresse du moniteur programmée, cela est indiqué par la led rouge fixe.

b) Depuis la platine.

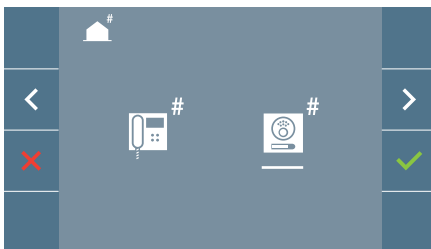

Option sélectionnée à l'aide de la ligne blanche sous l'icône. Appuyer sur , on entend un bip dans le moniteur.

Le moniteur se connecte automatiquement avec la platine de la rue en activant la caméra. Introduire depuis la platine le code d'appel pour ce moniteur. En fonction du type de platine installée :

- En appuyant sur le bouton-poussoir correspondant
- En introduisant le code + la cloche.

Notes :

- Le temps doit être inférieur à 2 minutes et demies depuis l'émission du bip de confirmation d'entrée dans la programmation du moniteur et la réalisation de l'appel depuis la platine pour programmer l'adresse du moniteur.
- La platine d'où est réalisée la programmation doit être comme une platine master.

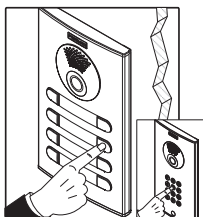
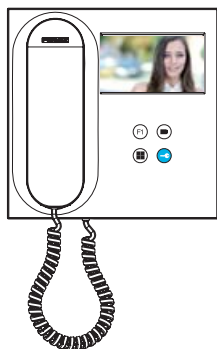

Une tonalité d'appel différente se produit, en confirmant la programmation du moniteur et l'image de la caméra est toujours à l'écran. Après quelques secondes écoulées, le moniteur repasse en mode inactif. Une fois l'adresse du moniteur programmée, cela est indiqué par la led rouge fixe.

c) Depuis la sonnette de la porte.

Par l'entrée de la sonnette de la porte T et -l'adresse du moniteur peut aussi se programmer.

Afin de pouvoir réaliser ce type de programmation, le moniteur ne doit pas être programmé au préalable.

Appuyer sur la sonnette de la porte pendant 5 secondes, un bip de confirmation d'entrée dans la programmation du moniteur se fera entendre.

Le moniteur se connecte automatiquement avec la platine de la rue en activant la caméra. Introduire depuis la platine le code d'appel pour ce moniteur, en fonction du type de platine installée :

- En appuyant sur le bouton-poussoir correspondant.
- En introduisant le code + la cloche.

Une tonalité d'appel différente se produit, en confirmant la programmation du moniteur et l'image de la caméra est toujours à l'écran. Après quelques secondes écoulées, le moniteur repasse en mode inactif. Une fois l'adresse du moniteur programmée, cela est indiqué par la led rouge fixe.

Notes :

- Le temps doit être inférieur à 2 minutes et demies depuis l'émission du bip de confirmation d'entrée dans la programmation du moniteur et la réalisation de l'appel depuis la platine pour programmer l'adresse du moniteur.
- La platine d'où est réalisée la programmation doit être comme une platine master.

3.2 MENU ADMINISTRATEUR : RÉINITIALISATION DES PARAMÈTRES

L'installateur peut réinitialiser les paramètres pour laisser le moniteur avec la configuration par défaut, en sélectionnant et en confirmant l'option.

La réinitialisation affecte aussi bien les paramètres de configuration de l'utilisateur que l'adresse du moniteur.

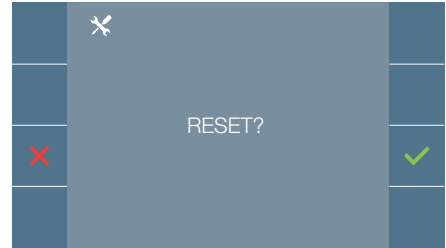
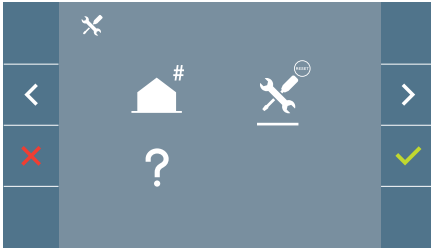

Note : La led rouge qui clignote rapidement indique que le moniteur n'est pas programmé. Comme la réinitialisation efface l'adresse programmée du moniteur, quand la led clignotera, elle indiquera que la réinitialisation est terminée.

3.3 MENU ADMINISTRATEUR : À PROPOS DE

Un code QR apparaît à l'écran permettant d'accéder à la documentation complète du moniteur.

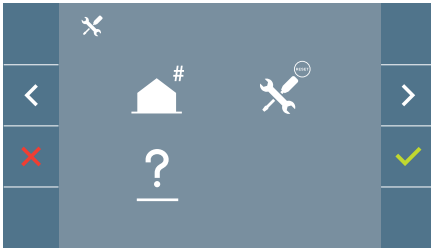

4. PROGRAMMATION : Écran MENU UTILISATEUR

En appuyant sur le bouton  MENU, on accède directement à l'écran du Menu de l'Utilisateur si le moniteur est programmé.

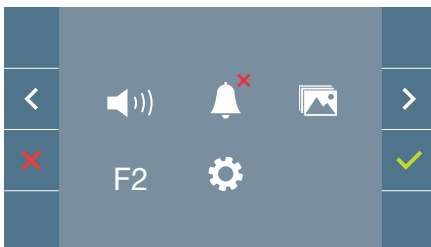

Il existe plusieurs options :

1. Réglage du volume du moniteur
2. Fonction ne pas déranger
3. Visualiser les images
4. Fonction F2
5. Réglages des paramètres d'utilisateur

4.1 MENU UTILISATEUR : RÉGLAGE DU VOLUME DU MONITEUR

Nous pouvons régler le volume de mélodie dans un rang de dix valeurs possibles.

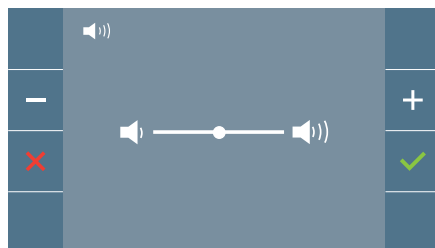
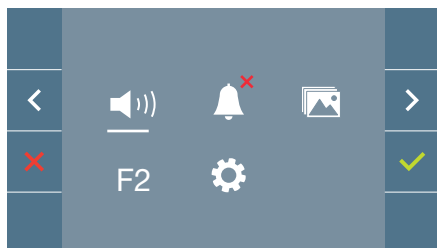

Dans un premier temps, le volume actuel apparaît et s'entend et il pourra augmenter (+) ou baisser (-) avec les boutons correspondants. Grâce à eux, nous pouvons obtenir le réglage souhaité.

4.2 MENU UTILISATEUR : MODE NE PAS DÉRANGER

Depuis cette icône, il est permis d'activer/désactiver le son de l'appel (*mode ne pas déranger*).

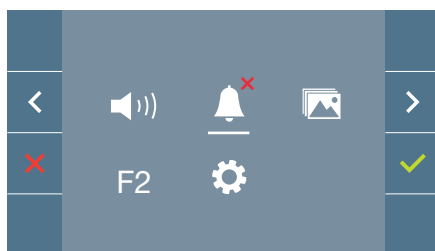
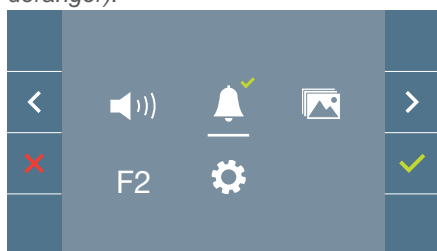

Appuyer sur l'icône ✓ pour changer la sélection. Le fonctionnement normal est sélectionné (*on entend l'appel*).

La led rouge du moniteur clignote lentement quand le mode ne pas déranger est activé.

4.3 MENU UTILISATEUR : VISUALISER LES IMAGES

Depuis cette icône, il est permis de visualiser les images capturées automatiquement et de les effacer. Pour plus d'informations [voir chapitre Fonctionnement Visualisation des images](#).

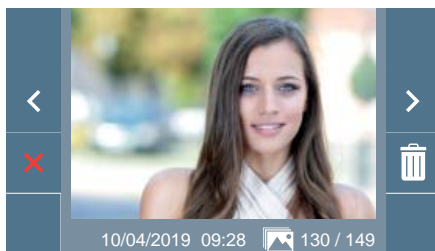
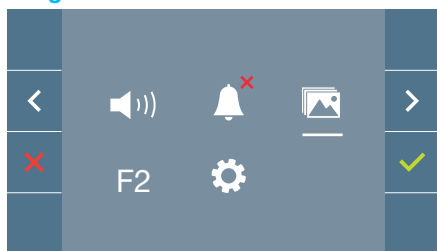

4.4 MENU UTILISATEUR : FONCTION F2

La fonction F2 envoie une instruction de déclenchement afin de pouvoir activer un appareil auxiliaire.

L'action sera annoncée sur l'écran : F2 ON pendant 3 secondes. Cette fonction est sur l'écran principal du menu de l'utilisateur.

L'instruction F2 est envoyée par le bus en incluant l'adresse du moniteur pour activer l'appareil auxiliaire connecté au bus, comme par exemple un relais duox (*consulter avec un installateur*).

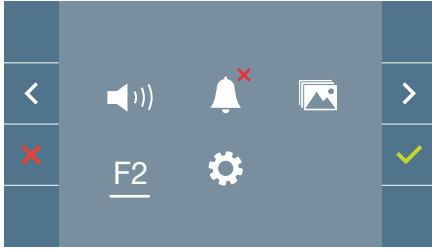

4.5 MENU UTILISATEUR : RÉGLAGES DES PARAMÈTRES D'UTILISATEUR

Dans le menu de l'utilisateur, en sélectionnant l'option « Réglages paramètres de l'utilisateur », on accède à un nouvel écran correspondant aux différents paramètres de configuration :

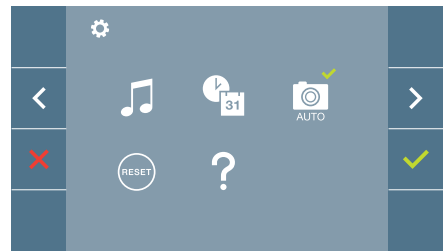
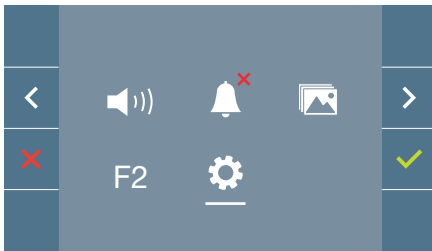

Les paramètres sont les suivants :

1. Sélection des mélodies
2. Réglage date et heure
3. Activation/Désactivation Capture d'images
4. Réinitialisation des paramètres de configuration
5. Aide à l'utilisateur

4.5.1. Réglages des paramètres d'utilisateur : SÉLECTION DES MÉLODIES

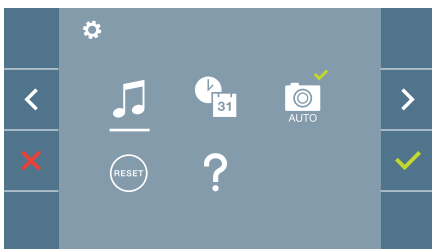

Le moniteur vous permet de sélectionner une mélodie différente pour les platines et pour la conciergerie. Les platines sont :

- Platine 0 du Bloc du moniteur.
- Platine 1 du Bloc du moniteur.
- Platine 0 de l'Entrée Générale.

Permet de choisir parmi 5 sons de mélodies différentes.

a) Sélection de mélodie de la platine

Platine 0 du Bloc du moniteur

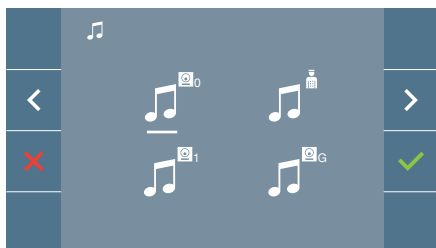

En sélectionnant cette option, il est possible de changer la mélodie que l'on entendra dans le moniteur lors d'un appel depuis la platine de rue 0 du bloc du moniteur.

Platine 1 du Bloc du moniteur

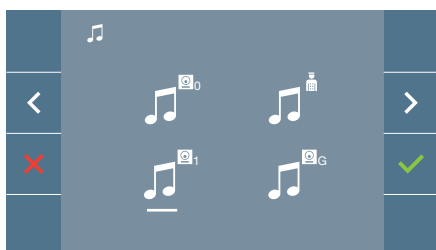

En sélectionnant cette option, il est possible de changer la mélodie que l'on entendra dans le moniteur lors d'un appel depuis la platine de rue 1 du bloc du moniteur.

Platine 0 de l'Entrée Générale

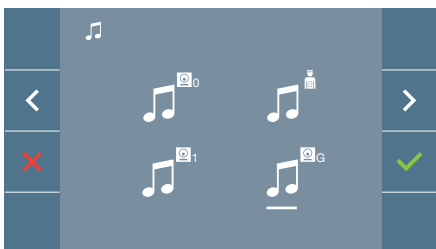

En sélectionnant cette option, il est possible de changer la mélodie que l'on entendra dans le moniteur lors d'un appel depuis la platine de rue 0 de l'entrée générale.

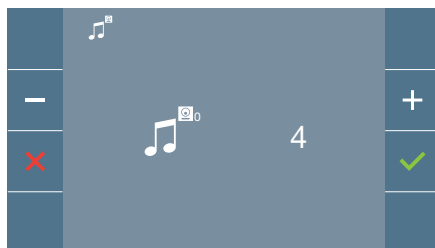

Une fois l'option sélectionnée, on entend la mélodie actuelle qui commence, en appuyant sur le bouton + ou -, il est possible de sélectionner et d'écouter les différentes mélodies disponibles sur le moniteur.

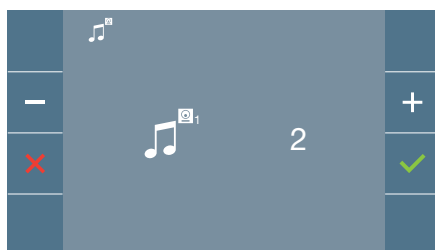

Une fois l'option sélectionnée, on entend la mélodie actuelle qui commence, en appuyant sur le bouton + ou -, il est possible de sélectionner et d'écouter les différentes mélodies disponibles sur le moniteur.

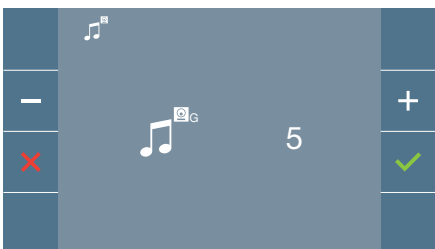

Une fois l'option sélectionnée, on entend la mélodie actuelle qui commence, en appuyant sur le bouton + ou -, il est possible de sélectionner et d'écouter les différentes mélodies disponibles sur le moniteur.

b) Sélection mélodie conciergerie

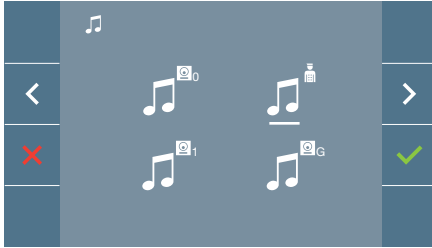

En sélectionnant cette option, il est possible de changer la mélodie que l'on entendra dans le moniteur quand la conciergerie appellera le moniteur.

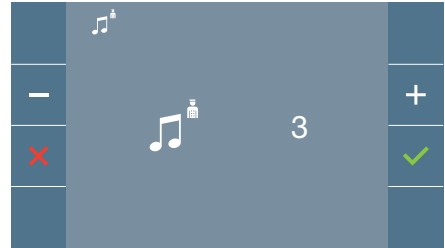

Une fois l'option sélectionnée, on entend la mélodie actuelle qui apparaît, en appuyant sur le bouton + ou -, il est possible de sélectionner et d'écouter les différentes mélodies disponibles sur le moniteur.

4.5.2. Réglages des paramètres d'utilisateur : RÉGLAGE DE LA DATE ET DE L'HEURE

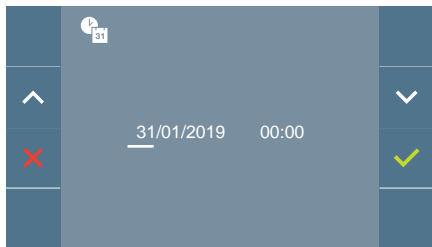
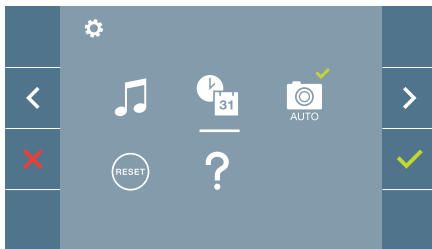



Le moniteur permet d'ajuster la date et l'heure.

À travers des icônes de navigation, il est possible de changer les réglages de date et d'heure, et donc de naviguer avec celles-ci. Appuyer sur l'icône ✓ pour changer la sélection.

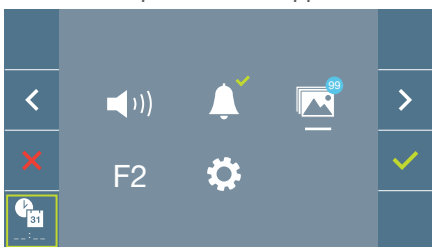
Si pour une raison quelconque il y a une coupure de courant, la configuration de la date et de l'heure sera celle par défaut (01/01/2019). Dans le moniteur, une icône indiquant que la date n'est pas correcte apparaîtra dans le menu de l'utilisateur.



Notes :

- Il n'est pas permis de valider avec des données incorrectes de date et d'heure, et la date et l'heure les plus proches sont proposées.
- En appuyant sur les icônes de navigation en continu  -  les chiffres changent plus vite.

4.5.3 Réglages des paramètres d'utilisateur : ACTIVATION/DÉSACTIVATION CAPTURE D'IMAGES

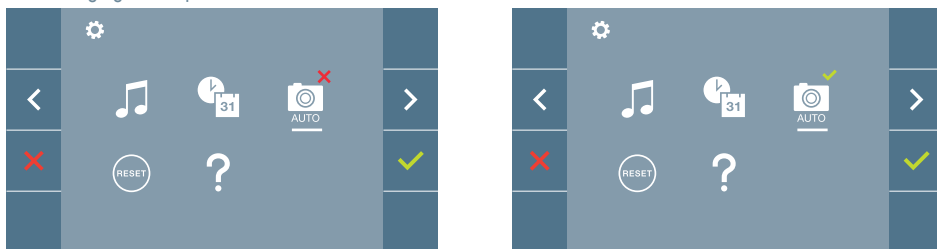

Depuis cette option, il est possible d'activer/désactiver la capture automatique d'images. Sélectionner l'icône de la capture d'images et appuyer sur confirmer  afin d'activer/désactiver.

L'écran peut prendre une photo automatique 3 secondes après avoir reçu un appel de la platine de rue. Conformément à la loi de protection des données (EU 2016/679) de l'Union Européenne, l'utilisation de la capture d'images du vidéophone peut être restreinte. Cette fonction est désactivée par défaut. Elle peut être activée depuis le moniteur sous votre responsabilité.

De la même façon, il peut être obligatoire de placer à côté de la platine de rue une pancarte indiquant que le moniteur peut capturer des images. Vous pouvez télécharger cette affiche sur le site suivant : <https://www.fermax.com/intl/fr/corporate/utilites.html>.

4.5.4. Réglages des paramètres d'utilisateur : RÉINITIALISATION DE L'UTILISATEUR

Avec cette option, tous les paramètres de configuration peuvent être réinitialisés à des valeurs d'usine, en conservant l'adresse programmée sur le moniteur. Sélectionner et confirmer l'option.

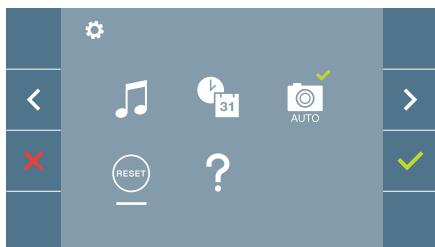

Si vous voulez réaliser la réinitialisation, confirmer l'option.

4.5.5. Réglages des paramètres d'utilisateur : AIDE

Un code QR apparaît sur l'écran permettant d'accéder à un lien promotionnel qui explique en détail le système numérique DUOX créé par FERMAX.

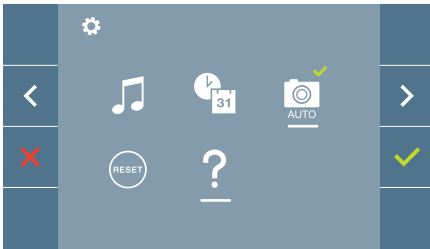

5. RÉGLAGES : VIDÉO ET AUDIO

5.1 RÉGLAGES : RÉGLAGES VIDÉO : BRILLANCE-CONTRASTE-COULEUR

Le moniteur permet de réaliser les réglages de brillance, contraste et couleur tout en ayant reçu un appel (*sans ouvrir la communication*) ou en réalisant un autoallumage (caméra). Voir chapitre **Fonctionnement : Autoallumage**.

En ayant l'image vidéo à l'écran, appuyer brièvement sur le bouton (☰) (Menu) et un menu contextuel pour le réglage de la brillance, le contraste et la couleur de l'image apparaîtra à l'écran.

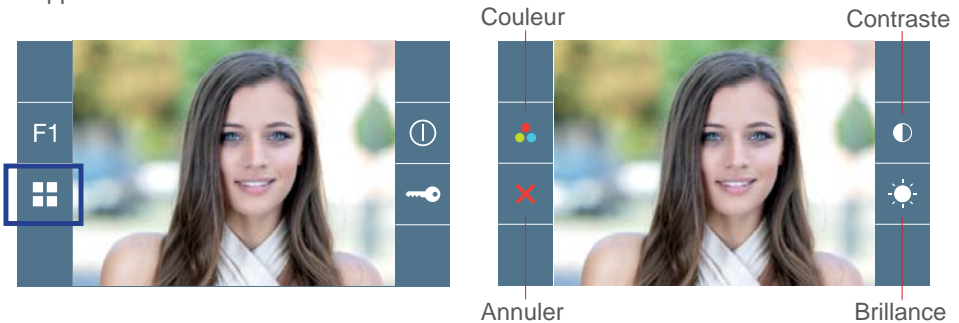

1. Sélectionner les réglages de contraste, brillance et couleur, avec les boutons correspondants.

Depuis ces écrans, on peut aussi activer l'audio (*ouvrir la communication*).

Note : Le temps pour réaliser les réglages de vidéo est de 30 secondes. Ce temps écoulé, le moniteur repassera en mode inactif. Depuis ces écrans, on peut aussi activer l'audio (ouvrir la communication).

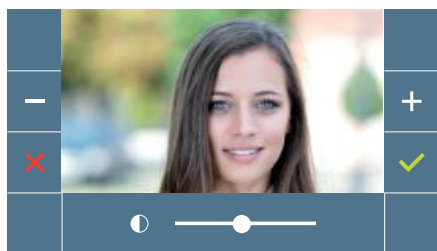

contraste

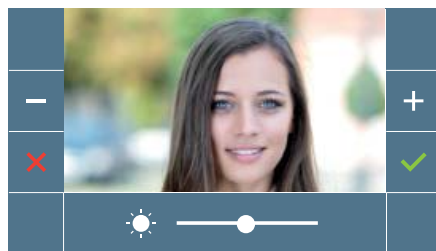

brillance

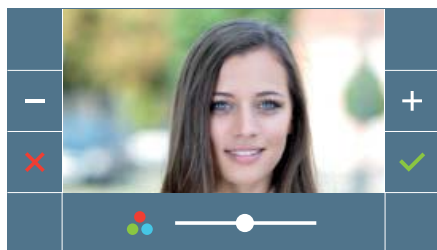

couleur

5.2 RÉGLAGES : RÉGLAGES AUDIO

Pendant le temps d'ouverture du canal audio, il est possible de régler son volume. Afin de réaliser le réglage, appuyer sur le bouton  (menu) et un menu contextuel apparaîtra à l'écran.

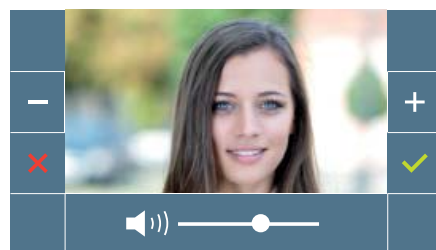
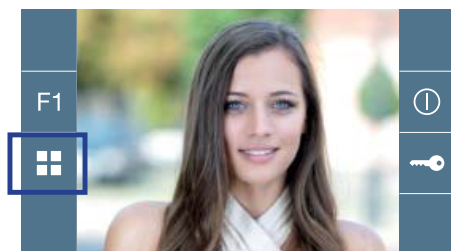

 Manuel Utilisateur : FONCTIONNEMENT

FONCTIONNEMENT

1. FONCTIONNEMENT : RÉPONDRE À UN APPEL Réception d'appel.

En appuyant sur le bouton-poussoir sur la **Platine de rue**, une tonalité d'appel se produit dans celle-ci et le moniteur, outre l'allumage de l'écran. On dispose de 30 secondes pour répondre avant de revenir en mode inactif. Pendant ce temps, la led rouge s'éteindra indiquant que l'appel est en attente de réponse.

Il est possible de décrocher le combiné et de maintenir une conversation avec la platine de rue. La communication se terminera automatiquement au bout de 90 secondes ou à tout moment en raccrochant le combiné du téléphone.

Notes :

- *S'il y a plusieurs moniteurs/téléphones dans le même logement, seul le premier qui décrochera obtiendra la mise en communication, les autres moniteurs/téléphones repassant en mode inactif. Si l'on tente d'en décrocher un d'entre eux, on aura une tonalité de ligne occupée.*
- *Si la communication ne s'établit pas (en décrochant le combiné) avec la platine de rue, le moniteur s'éteint automatiquement au bout de 30 secondes.*

En recevant un appel depuis la platine de la rue, il est possible d'ouvrir la porte à tout moment, en appuyant sur le bouton .

1.1 Appel vidéo.

Dans le cas où l'appartement reçoit un appel depuis une platine vidéo, le moniteur affichera la vidéo capturée par la caméra de la platine extérieure.

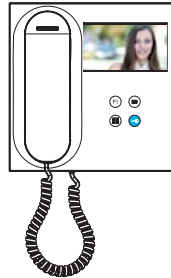

1.2 Appel audio.

Dans le cas où l'appartement reçoit un appel d'une platine audio, l'écran suivant s'affiche :

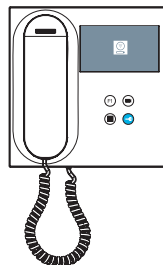

1.3 Appel à la Conciergerie.

Si un moniteur est configuré en mode MIXTE ou en mode JOUR, appuyer sur la gâche lorsqu'il est inactif déclenchera un appel à la dernière conciergerie qui l'a configuré dans ce mode. L'écran du moniteur affiche l'image suivante et une tonalité d'appel retentit.

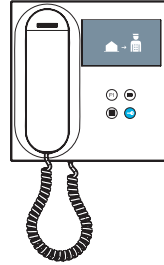

Si vous recevez un appel du concierge sur le moniteur d'appartement, l'image suivante s'affiche :

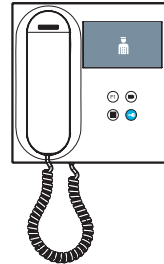
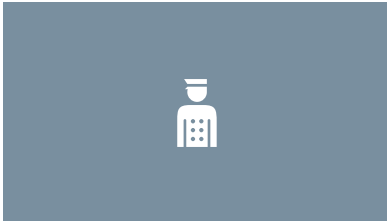

2. FONCTIONNEMENT : ACTIVATION MANUELLE DU MONITEUR (AUTOALLUMAGE)

Lorsque le moniteur est en Stand by, appuyer sur la touche  (caméra) pour allumer manuellement le moniteur.

Les temps de prévisualisation sans audio (30sec) ou de conversation (90sec) au total, même si vous changez de caméra.

Autoallumage en Stand by :

1. Si l'appel précédent depuis la platine s'est terminé il y a moins de 15 secondes, cette même platine est rappelée : **R**.



2. Si le point précédent ne se produit pas, l'autoallumage commence avec les différentes platines prises en charge par le moniteur.

En appuyant consécutivement Platine 0, Platine 1, Platine Générale, (selon disponibilité des platines).

- 1 Platine 0 ou Caméra 0 du Bloc du moniteur.
- 2 Platine 1 ou Caméra 1 du Bloc du moniteur.
- 3 Platine 0 ou Caméra 0 de l'Entrée Générale.



Une fois la communication avec une platine établie, elle peut être modifiée en appuyant sur le bouton poussoir  (caméra).

Autoallumage lors de la réception d'un appel :

1. Si l'appel provient d'une platine de la séquence décrite au point précédent, l'autoallumage continue à la platine suivante de la séquence.
2. Si l'appel ne provient PAS d'une platine, l'autoallumage démarre avec la platine de bloc 0, (selon la disponibilité de la platine) et suit la séquence ::



1 Platine 0 ou Caméra 0 du Bloc du moniteur



2 Platine 1 ou Caméra 1 du Bloc du moniteur



3 Platine 0 ou Caméra 0 de l'Entrée Générale

Notes :

- L'autoallumage ne peut être effectué qu'avec les platines indiquées. Si vous ne parvenez pas à effectuer l'autoallumage, consultez votre installateur. Une fois que vous avez tenté de vous connecter sans succès aux trois platines possibles, le moniteur émettra une tonalité d'erreur et se remet en Stand by.
 - A la fin de toute communication avec une platine, si le bouton d'autoallumage est pressé à nouveau dans les 15 secondes, il se connectera à la platine.
- Autoallumage sans établir d'audio, si l'ouverture de porte se fait dans les 5 secondes, l'appel prend fin.
- Si un second moniteur effectue un autoallumage, il existe plusieurs cas de figure :
 - o Le premier moniteur est en autoallumage et n'a pas établi de conversation audio : Dans ce cas, l'autoallumage du deuxième moniteur n'est pas autorisé.
 - o Le premier moniteur a effectué un autoallumage et a établi une conversation audio : la configuration de l'autoallumage peut démarrer.
 - o Dans tous les cas, une fois la conversation ou l'autoallumage avec vidéo du premier moniteur terminé, le second moniteur est autorisé à démarrer l'autoallumage.

3. FONCTIONNEMENT : VISUALISATION DES IMAGES

Fonction pour voir toutes les captures d'images réalisées. La fonction capture d'images doit être activée au préalable. [Voir chapitre 4.5 Menu UTILISATEUR - 4.5.3 Activation/Désactivation des images.](#)

En réalisant un appel depuis la platine de la rue, (a fonction capture d'images doit être activée au préalable), une photo est réalisée automatiquement après 3 secondes, et elle se stockera dans la mémoire.

Note : Le nombre maximum d'images que l'on peut garder est de 150. Si l'on stocke une nouvelle image avec la mémoire pleine, l'image la plus ancienne s'effacera.

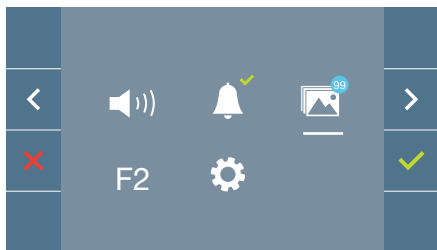

Sélectionner l'icône  pour visualiser les différentes photos réalisées.

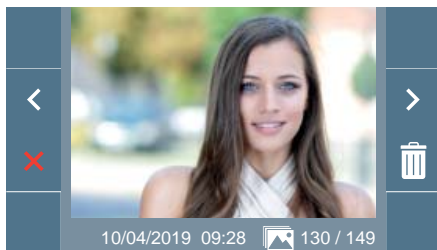

L'image la plus récente apparaît avec la date, l'heure et le nombre de photos.



Un menu contextuel apparaît :

  : Pour sélectionner/visualiser les photos enregistrées.

 : Pour effacer les images.

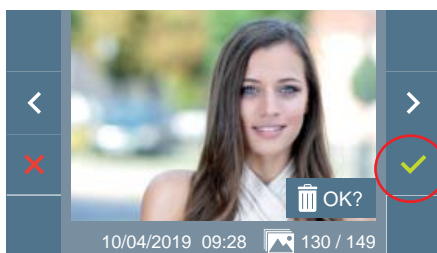
 : Pour annuler et aller à l'écran précédent.



Si l'on appuie sur la fonction de suppression  on accède à l'écran de confirmation de suppression d'images, en appuyant sur l'icône de confirmation  a photo sélectionnée s'effacera. L'utilisateur peut naviguer à travers les photos enregistrées, y compris lorsque la fenêtre de confirmation est activée.

Note : Si vous maintenez l'icône de confirmation enfoncée  pendant 5 secondes, toutes les images peuvent être effacées après confirmation.

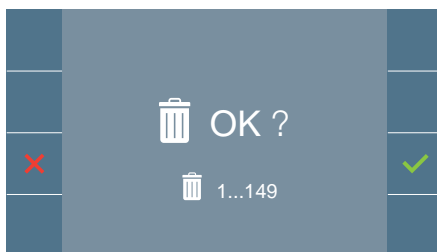

Dans le cas où il y aurait des captures d'images qui n'auraient pas été visualisées par l'utilisateur, des notifications apparaîtront sur l'icône du menu de l'utilisateur et sur l'écran de Vidéo.

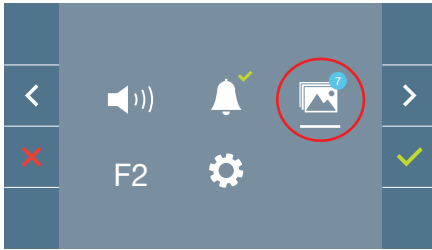

L'icône de visualisation d'images change en montrant un cercle bleu avec le nombre d'images à regarder (maximum 99). Sur le cercle, le nombre d'images vues par l'utilisateur aura été enlevé.



Quand un appel se produit, on est informé de l'existence de photos non vues, mais le nombre n'est pas précisé dans ce cas présent.

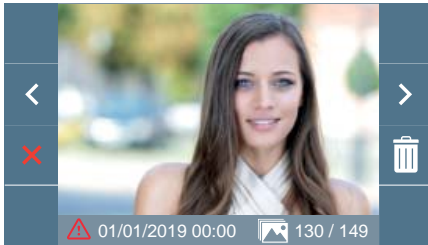

Si pour une raison quelconque il y a une coupure de courant, la configuration de la date et de l'heure sera celle par défaut (01/01/2019).

Si l'on capture une image sans avoir ajusté la date et l'heure, cette icône apparaîtra pendant la visualisation de l'image , en nous indiquant que les réglages de la date et de l'heure qui apparaissent avec l'image, ne sont pas corrects.



L'appareil que vous avez acheté porte un marquage conforme à la directive 2012/19/UE relative aux déchets d'équipements électriques et électroniques (DEEE). En savoir plus :





WIR GRATULIEREN IHNEN ZU DIESEM QUALITÄTSPRODUKT!!
FERMAX entwickelt und produziert hochwertige Geräte, die den höchsten Design- und Technologiestandards gerecht werden. Wir hoffen, dass Sie sich an seinen Funktionen erfreuen.

*Technische Publikation mit informativem Charakter herausgegeben von FERMAX ELECTRÓNICA S.A.U.
Im Rahmen der kontinuierlichen Qualitätsverbesserung behält sich FERMAX ELECTRÓNICA das Recht vor, den Inhalt dieses Dokuments und die Eigenschaften der darin enthaltenen Produkte jederzeit ohne vorherige Ankündigung zu ändern.
Alle Änderungen werden in späteren Ausgaben dieses Dokuments berücksichtigt.*





Dieses Produkt ist durch die folgenden Patente und Gebrauchsmuster geschützt:

PATENTE: US 9215410, US 9762852, BE1023440, AU2014203706.

NUTZMODELLE: ES1187384U, ES1141495U, FR3038192, DE202016000632U1, CN205987229(U).

Cod. 970159 V04_19

INHALTSVERZEICHNIS

	EINLEITUNG	4
	INSTALLATION	5
	-Installation Monitor	5
	-Verbindungen	6
	TECHNISCHE EIGENSCHAFTEN	8
	PRODUKTBESCHREIBUNG	9
	- Tasten	9
	- LEDs	10
	- Induktionsschleife	10
	PROGRAMMIERUNG	10
	1. Zugriff auf das Administrator- und Benutzermenü	10
	2. Navigations- und Monitortasten	12
	3. Administratormenü	12
	1. Programmierung Ausrichtung Monitor	12
	2. Einstellungs-Reset	15
	3. Information/Hilfe	15
	4. Benutzermenü	15
	1. Einstellung der Lautstärke	16
	2. Nicht stören-Funktion	16
	3. Bilder anzeigen	16
	4. Funktion F2	17
	5. Benutzereinstellungen	17
	5. Audio- und Videoeinstellungen	21
	FUNKTIONSWEISE	23
	1. Anrufentgegennahme	24
	2. Manuelle Aktivierung des Monitors (Auto-Einschaltung)	25
	3. Anzeige von Bildern	27



EINLEITUNG

Der VEO DUOX Monitor stellt ein neues elektronisches Design dar, das die DUOS Audio- und Video-Technologie, Stromversorgung und Datenleitung über zwei nicht polarisierte Drähte integriert.

Die Haupteigenschaften des Duox-Systems sind die Folgenden:

- Spannungsversorgung der Monitore über Bus mit 18 VDC / 24 VDC.
- Gesprächsgeheimhaltung.
- Verpolungssichere Bus-Verdrahtung.

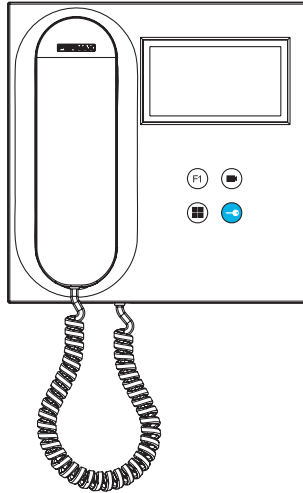

FUNKTIONEN

Die verfügbaren Funktionen des VEO DUOX sind in der folgenden Liste zusammengefasst:

- Türöffnung.
- Pförtneruf.
- Regulierung der Anruflautstärke.
- Rufabschaltung (Nicht stören).
- 1. Melodieauswahl.
- Türklingel.
- Programmierung von der Türstation, dem Monitor und der Türklingel.
- Audio-Lautstärkeregelung.
- Einstellungen für Bildschirmmenü (OSD).
- Einstellen von Helligkeit, Kontrast und Farbe.
- Hilfsfunktionen F1 und F2
- Induktionsschleife (*je nach Modell*).
- Bildaufzeichnung (*mit Speicher*).



INSTALLATION

INSTALLATION MONITOR

Anschlusssocket

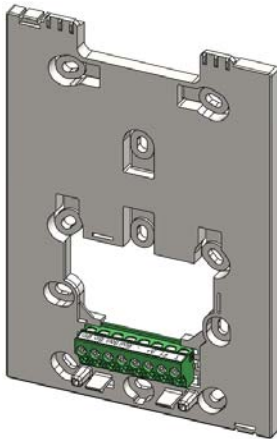

Oberflächenverkabelung

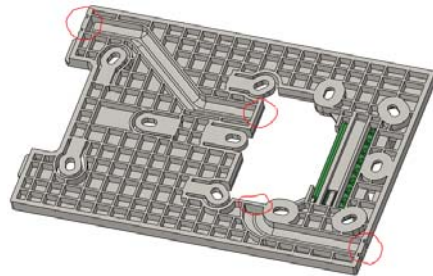

Für nicht eingebettete Installationen verfügt der Socket über zwei Kanäle, um die Kabel vom Boden oder der Decke aus zur Anschlussleiste zu führen. Zwei der markierten Trennwände müssen mit einem Abisolierer entfernt werden, um den Kabelzugang von unten oder oben zu ermöglichen.

Montage des Monitors

1

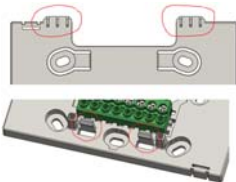

Der Monitor wird an den beiden oberen Ösen des Sockels eingehängt und wird von zwei Klammern im unteren Bereich gehalten.

2

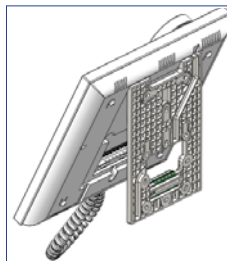
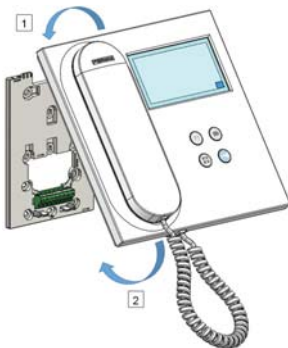

Die folgende Abbildung zeigt den Monitor während des Einhängens am Socket, bevor er zum Abschluss der Montage heruntergeklappt wird.

Platzieren Sie den Monitor in einem Winkel zwischen 15 und 30 Grad zum Socket und hängen Sie ihn an den oben genannten Halterungen ein. Klappen Sie den Monitor über den Socket und üben Sie auf beiden Seiten des unteren Endes Druck auf die Wand aus, bis Sie hören oder bemerken, dass die unteren Crimps geschlossen sind.

3



Um den Monitor zu positionieren und den Halt zu verstärken, verfügt der Socket über zwei Führungen auf beiden Seiten der Crimpzangen.

Demontage des Monitors

a)

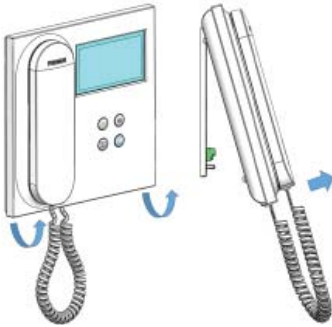

a) An der Wand montiert

Der Sockel ist so konzipiert, dass der Monitor ohne Werkzeug entfernt werden kann. Dazu ziehen Sie einfach die unteren Ecken senkrecht zur Wand, bis die Crimps entriegelt sind und ein Mindestwandwinkel von 10 Grad erreicht ist. Lösen Sie dann den Monitor von den oberen Ösen des Sockels.

b)



b) Monitor und Sockel verbunden

Für den Fall, dass Monitor und Sockel verbunden sind ohne dass diese an einer Wand verankert sind, ist es notwendig, sie mit einem flachen Schraubendreher zu hebeln und wie angegeben zu trennen.

ANSCHLÜSSE

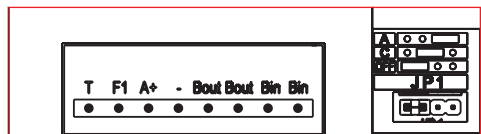
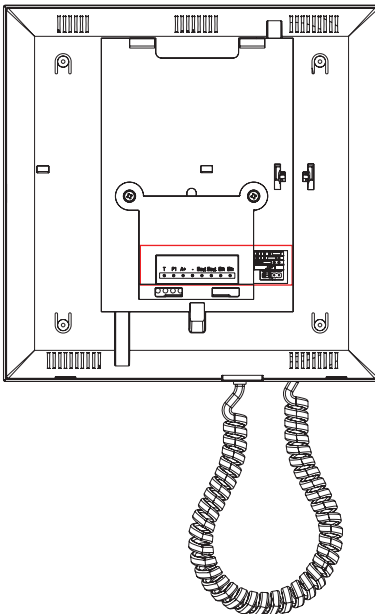

Anschlüsse Monitor:

Bin,Bin: Daten-, Audio- und Videoeingang.

Bout,Bout: Daten-, Audio- und Videoeingang (für Kaskadenanschluss).

T, -: Anruftaste von Tür zu Wohneinheit(P1).

A+, -: Anschlussfolgender Geräte möglich:

- Anruferweiterer ref. 2040.
- Licht- und Summeraktivator ref. 2438.

F1: Zusatzfunktion. (Minus-Ausgang „-“ / Befehlsendung, *siehe Kapitel Tasten: Zusatzfunktion F1*).

JP1: Brücke integrierter Netzadapter

- Rechts: Anpassung Typ A.
- Mitte: Anpassung Typ C.
- Links: Ohne Leitungsanpassung: OFF (Standard).

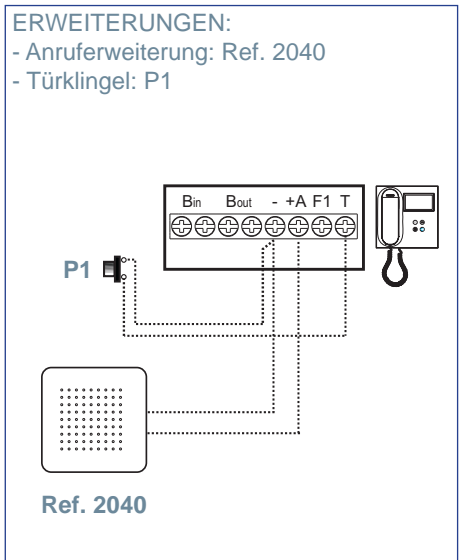
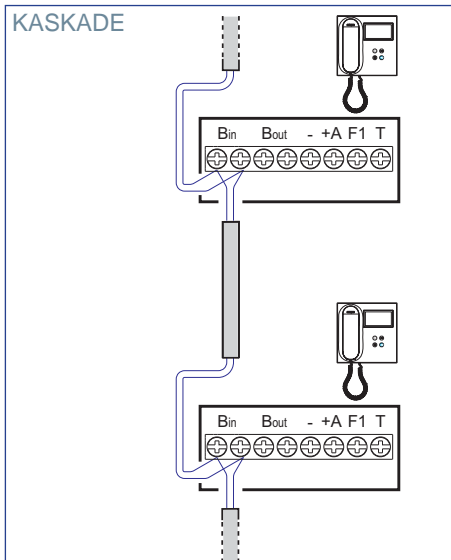
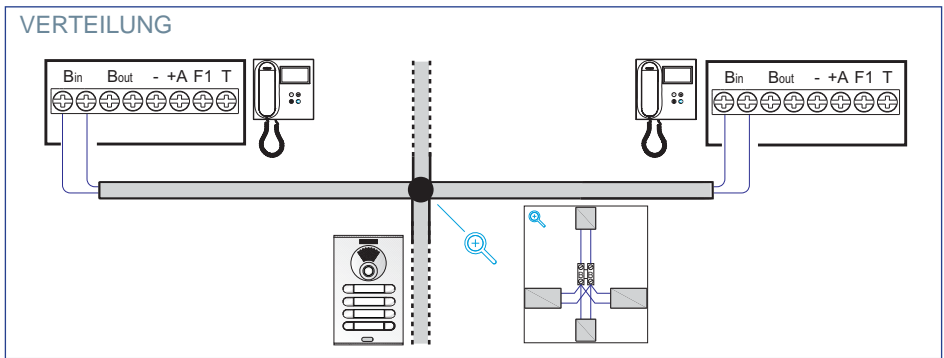

ERWEITERUNGEN: Licht- und Summeraktivator ref. 2438

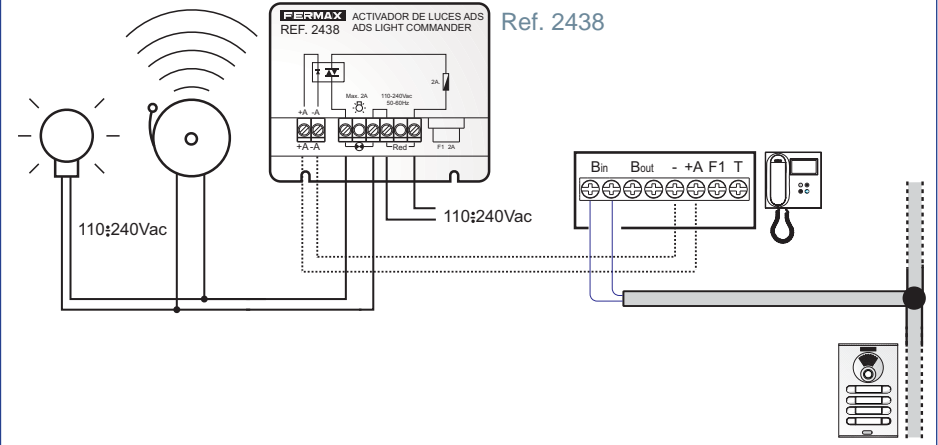

TECHNISCHE EIGENSCHAFTEN

Stromversorgung (ohne Polarität)	18 - 24 VDC
Verbrauch	
Verbrauch im Standby	0,8 W
Maximaler Verbrauch	5,2 W
Anzahl der Terminals pro Wohnung	3
Adresse jedes Monitors: 6 Ziffern	000001...999999
Betriebstemperatur	[-5° , +40° C] / [23° , 104° F]
Luftfeuchtigkeit	[0% - 90%]
OSD Bildschirm	TFT 4.3"
Auflösung	
Horizontal:	480 Line TV
Vertikal:	272 Line TV
MaßeMonitor (Höhe x Breite x Tiefe)	200 x 200 x 46mm - 8" x 8" x 1.8"

Wichtiger Hinweis: Dieser VEO-Monitor ist kompatibel mit VEO- und VEO XS-Monitoren in den Versionen V2.x und V3.x.

Wenn einer der Monitore der angegebenen Versionen ausgetauscht wird, muss auch der Sockel des Monitors ausgetauscht werden. Der Sockel des aktuellen Monitors hat die Referenz 9447.

PRODUKTBESCHREIBUNG

VEO Monitor

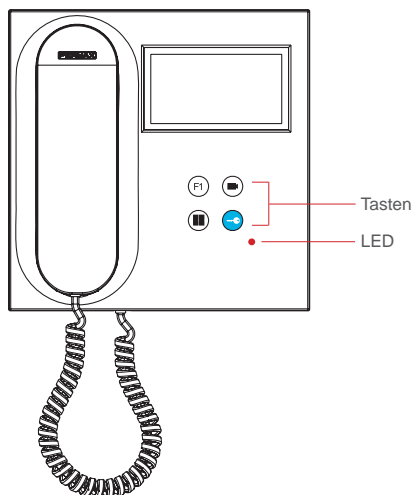

TASTEN



Türöffner / Pförtnerurf.

- Bei der Kommunikation mit der Türstation (*nur Audio oder Video oder Audio + Video*), wird mit dieser Taste der Türöffner betätigt.
- Bei aufgehängtem Hörer (*Monitor im Ruhezustand*), kann mit dieser Taste der Pförtner angerufen werden (wenn es eine Pförtnerzentrale gibt und der Monitor im Tag-Modus eingestellt ist).



Auto-Einschaltung.

Verbindung mit Kamera vom allgemeinen Anschlussblock oder vom Zugang (*Funktion je nach Installationstyp verfügbar, siehe Kapitel Funktionsweise: Auto-Einschaltung*).



Hilfsfunktion F1

Hilfsfunktion (Minus-Ausgang „-“ / Befehlsendung).

Minussignal: *Minus-Ausgang über die Klemme F1 durch Drücken der Taste F1 und es erfolgt ebenfalls ein F1-Befehl, um ein Zusatzgerät zu aktivieren.*



Menü-Taste.

· Um zuzugreifen auf:

- **Programmierungsmenü**, in das man gelangt, wenn der Monitor nicht programmiert ist. Von diesem Menü lässt sich die Programmierung des Monitors je nach Installierungsanforderungen vornehmen.
- **Benutzermenü**, (nach Programmierung des Monitors). In diesem Menü lässt sich auf die Benutzereinstellungen für die Personalisierung zugreifen.

LEDs

● Rote LED:

Schnell blinkend. Monitor ist nicht programmiert.

Langsam blinkend. Zeigt an, dass die Nicht stören-Funktion aktiviert ist.

Eingeschaltet. Monitor im Ruhezustand.

Induktionsschleife

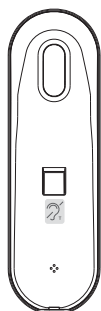

Induktionsschleife. Wird mit dieser Kennzeichnung angegeben (je nach Modell). Es gibt ein VEO Monitor-Modell mit Induktionsschleife in der Gabel des Monitors. [Siehe 97507 Telefongabel Induktionsschleife auf www.fermax.com](http://www.fermax.com).

- Beinhaltet eine induktive Hörfunktion, die mit Hörgeräten von Hörgeschädigten in Wechselwirkung tritt.

Hinweis: Hörgeräte mit manueller Reglereinstellung, müssen im digitalen Modus eingestellt sein.



PROGRAMMIERUNG:

1. PROGRAMMIERUNG: ZUGRIFF AUF DAS ADMINISTRATOR- UND

BENUTZERMENÜ

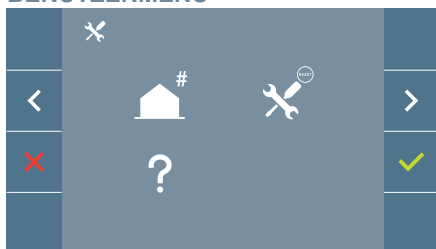

Bildschirm: ADMINISTRATORMENÜ

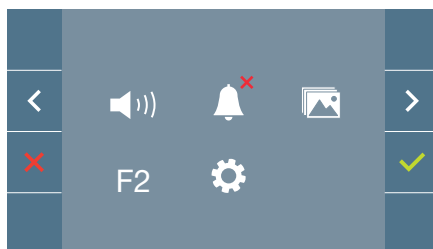

Bildschirm: BENUTZERMENÜ

Die Symbole für die Nicht stören-Funktion (Bildschirm: Benutzermenü) und der Bildaufzeichnung (Bildschirm Benutzermenü. Benutzereinstellungen) wechseln in Abhängigkeit davon, ob sie aktiviert/deaktiviert sind. Wenn Sie aktiviert sind, wird ein grüner Haken ✓ oben rechts von dem Symbol angezeigt, während ein rotes Kreuz ✗ angezeigt wird, wenn sie deaktiviert sind.

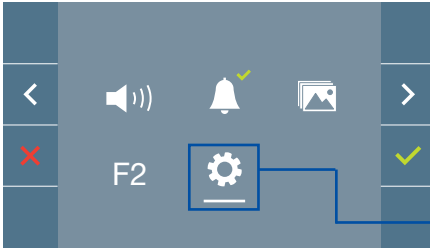

Bildschirm: BENUTZERMENÜ

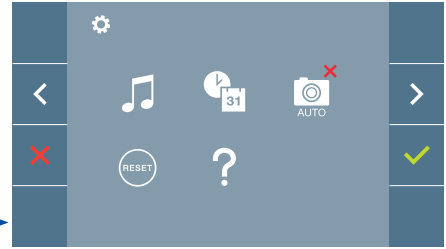

Bildschirm: Benutzereinstellungen im BENUTZERMENÜ.

Beim Drücken der Taste  **MENÜ**, gelangt man direkt zu:

- Der Möglichkeit, das Administratormenü des Monitors zu programmieren, wenn der Monitor nicht programmiert ist.
- Zu dem Bildschirm des Benutzermenüs, wenn der Monitor programmiert ist.

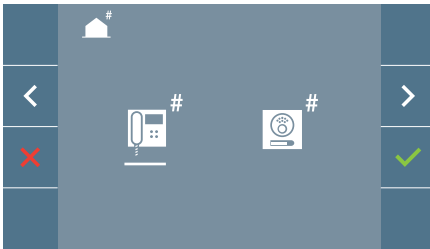

Bildschirm: Möglichkeit der Programmierung des ADMINISTRATORMENÜS des Monitors.

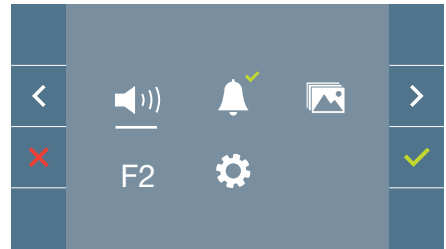

Bildschirm: BENUTZERMENÜ

Um auf das Administratormenü zuzugreifen wenn der Monitor programmiert ist, müssen zwei Schritte durchgeführt werden:

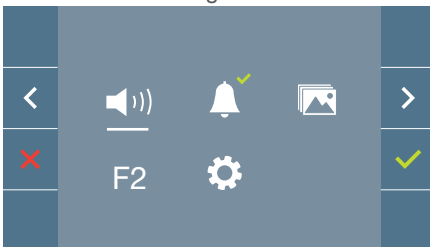

1. **MENÜ**-Taste  drücken , um auf das **Benutzermenü** zuzugreifen.





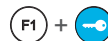



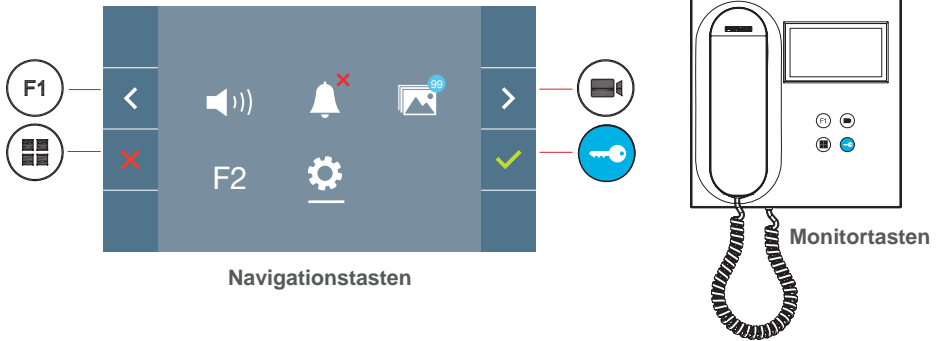

2. Im Benutzermenü gleichzeitig zwei Tasten drücken:



2. PROGRAMMIERUNG: NAVIGATIONS- UND MONITORTASTEN



Die auf dem Bildschirm angezeigten Symbole (*Navigationstasten*: , ,  und ), werden mit den entsprechenden Knöpfen an dem Monitor bedient:

- : Zurück zum vorherigen Bildschirm oder Stand-by.
- : Vorherige Option des Menüs.
- : Nachfolgende Option des Menüs.
- : Bestätigt die Wahl und aktiviert die Funktion.

Hinweise:

- Die weiße Linie unter dem Symbol zeigt die aktuelle Funktion an. Bei Drücken wird diese gewählt.
- Der Monitor verlässt die Programmierung automatisch nach 60 Sekunden der Inaktivität.

3. PROGRAMMIERUNG: Bildschirm ADMINISTRATORMENÜ

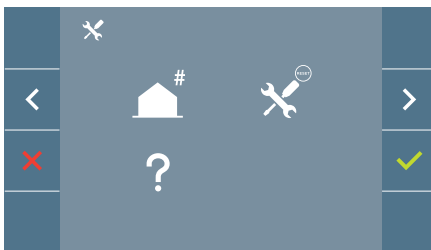

Es gibt mehrere Möglichkeiten:

1. Programmierung der Ausrichtung des Monitors.
2. Einstellungs-Reset
3. Information/Hilfe.

3.1 ADMINISTRATORMENÜ: PROGRAMMIERUNG Ausrichtung Monitor

Der Monitor ist ohne vorherige Programmierung nicht betriebsbereit!

Hinweis: Das langsame Blinken der blauen LED zeigt an, dass der Monitor nicht programmiert ist. Sobald die Ausrichtung des Monitors programmiert wurde, wird dies durch die permanent leuchtende rote LED angezeigt.

Es gibt drei Möglichkeiten zur Programmierung des Monitors:

- a) Von dem Monitor.
- b) Von der Türstation.
- c) Von der Türklingel.

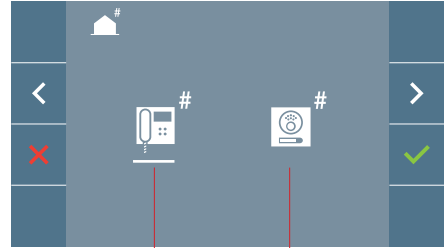

Von dem Monitor Von der Türstation

a) Von dem Monitor.

Der Monitor kann über das Bildschirmmenü programmiert werden.

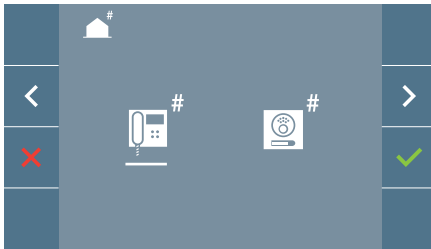

Programmierung der Rufnummer: ✓ auf dem vorherigen Bildschirm drücken, um auf den Bildschirm für die Programmierung der Wohnungsnummer zu gelangen (*Zahlen von rechts nach links*).

Jedes Mal, wenn + gedrückt wird, erhöht sich die Ziffer (*beginnend bei 1*) und mit der **Pfeiltaste** wechselt man die Stelle. Ein weißer Cursor zeigt die Eingabeposition der Ziffer an. Stellen Sie die entsprechende Nummer ein und bestätigen Sie mit ✓. Sobald die Monitoradresse programmiert ist, wird dies durch die rote LED angezeigt.

b) Von der Türstation.

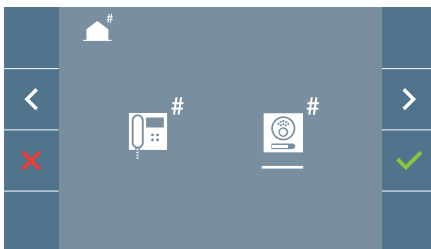

Die Auswahl wird durch die weiße Linie unter dem Symbol angezeigt. Beim Drücken von ✓, ertönt ein Piepton auf dem Monitor.

Der Monitor verbindet sich automatisch mit der Türstation und aktiviert die Kamera. Von der Türstation ist der Rufcode für diesen Monitor einzugeben. Daraufhin je nach installierter Türstation:

- Die entsprechende Taste drücken
- Den Code eingeben + klingeln.

Hinweise:

- Der Bestätigungs-Piepton bei Programmierungsbeginn und der Rufaufbau von der Türstation für die Programmierung der Monitoradresse, müssen innerhalb einer Dauer von zweieinhalb Minuten liegen.
- Die Türstation, von der die Programmierung erfolgt, muss als Haupttürstation eingestellt sein.

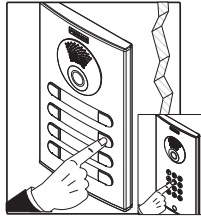
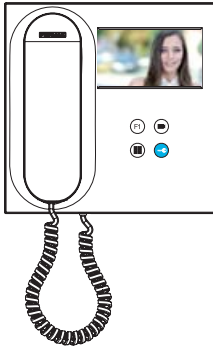

Ein unterschiedlicher Rufton signalisiert die Monitorprogrammierung, während das Kamerabild weiter eingeblendet wird. Nach einigen Sekunden kehrt der Monitor in den Ruhezustand zurück. Sobald die Monitoradresse programmiert ist, wird dies durch die rote LED angezeigt.

c) Von der Türklingel.

Über die Eingabe auf der Türklingel von T und - lässt sich ebenfalls die Monitoradresse einstellen.

Um diese Programmierung durchzuführen, sollte der Monitor nicht zuvor programmiert worden sein.

Bei Drücken der Türklingel für 5 Sekunden, ertönt der Bestätigungs-Piepton für den Programmierungsbeginn des Monitors.

Der Monitor verbindet sich automatisch mit der Türstation und aktiviert die Kamera. An der Türstation ist der Rufcode für diesen Monitor einzugeben. Daraufhin je nach installierter Türstation:

- Die entsprechende Taste drücken
- Den Code eingeben + klingeln

Ein unterschiedlicher Rufton signalisiert die Monitorprogrammierung, während das Kamerabild weiter eingeblendet wird. Nach einigen Sekunden kehrt der Monitor in den Ruhezustand zurück. Sobald die Monitoradresse programmiert ist, wird dies durch die rote LED angezeigt.

Hinweise:

- Der Bestätigungs-Piepton bei Programmierungsbeginn auf dem Monitor und der Rufaufbau von der Türstation für die Programmierung der Monitoradresse, müssen innerhalb einer Dauer von zweieinhalb Minuten liegen.
- Die Türstation, von der die Programmierung erfolgt, muss als Haupttürstation eingestellt sein.

3.2 ADMINISTRATORMENÜ: **EINSTELLUNGS-RESET**

Der Installateur kann ein Reset mit der entsprechenden Auswahl und Bestätigung durchführen, um die standardmäßige Werkseinstellung wiederherzustellen.

Das Reset wirkt sich sowohl auf die Benutzereinstellungen als auch auf die Monitoradresse aus.



Hinweis: Das schnelle Blinken der roten LED zeigt an, dass der Monitor nicht programmiert ist. Da das Reset die Monitoradresse löscht, zeigt die langsam blinkende LED an, dass das Reset abgeschlossen ist.

3.3 ADMINISTRATORMENÜ: **INFORMATIONEN/HILFE**

Auf dem Bildschirm wird ein QR-Code angezeigt, mit dessen Hilfe man auf die gesamten Dokumente des Monitors zurückgreifen kann.



4. PROGRAMMIERUNG: **Bildschirm BENUTZERMENÜ**

Durch Drücken der Taste  MENÜ, hat man direkten Zugriff auf das Benutzermenü, wenn der Monitor programmiert wurde.

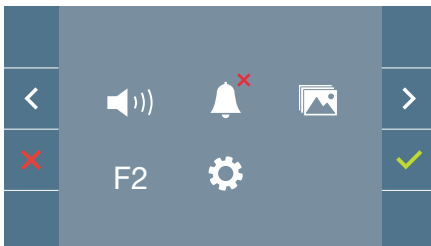

Es gibt mehrere Möglichkeiten:

1. Einstellung der Monitor-Lautstärke
2. Nicht Stören-Funktion
3. Bilder anzeigen
4. Funktion F2
5. Benutzereinstellungen

4.1 BENUTZERMENÜ: **EINSTELLUNG DER MONITOR-LAUTSTÄRKE**

Sie können die Lautstärke der Melodie in einem Bereich von zehn möglichen Werten einstellen.

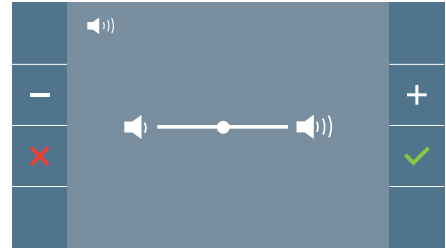
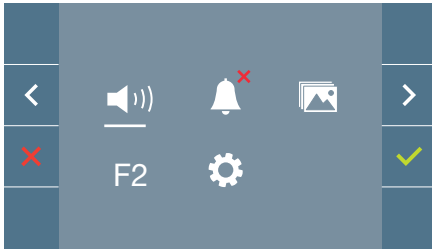

Zuerst erscheint und ertönt die aktuelle Lautstärke, die mit den entsprechenden Tasten (+) erhöht oder (-) gesenkt werden kann. Stellen Sie anhand dieser die gewünschte Lautstärke ein.

4.2 BENUTZERMENÜ: **NICHT STÖREN-MODUS**

Mit diesem Symbol können Sie den Rufton (*Nicht stören-Modus*) aktivieren/deaktivieren.

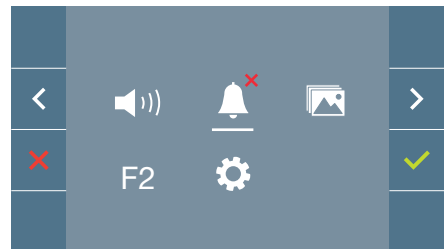
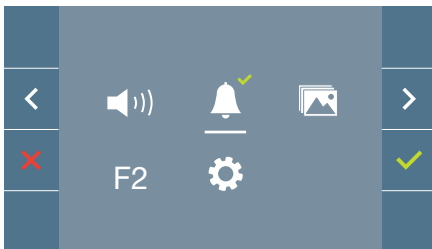

Um die Auswahl zu ändern, drücken Sie . Standardmäßig ist die normale Funktionsweise eingestellt (*Anrufe sind vernehmbar*).

Wenn der Nicht stören-Modus eingestellt ist, blinkt die rote LED des Monitors langsam.

4.3 BENUTZERMENÜ: **BILDER ANZEIGEN**

Mit diesem Symbol lassen sich aufgenommene Bilder automatisch wiedergeben und löschen. Für weitere Informationen [siehe Kapitel Funktionsweise: Anzeige von Bildern](#).

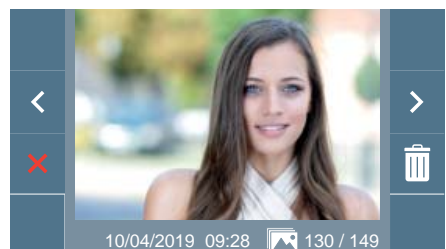
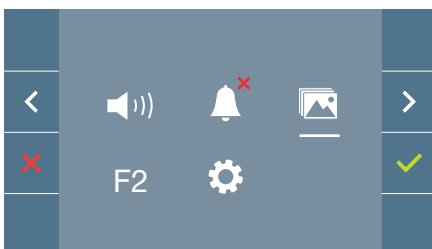

4.4 BENUTZERMENÜ: F2-FUNKTION

Die F2-Funktion sendet einen Befehl zur Aktivierung eines Zusatzgeräts.

Auf dem Bildschirm wird angezeigt: F2 ON (für 3 Sekunden). Diese Funktion befindet sich auf dem Hauptbildschirm des Benutzermenüs.

Es wird ein F2-Befehl mit der Monitoradresse über den Bus gesendet, um das am Bus angeschlossene Zusatzgerät, wie z. B. ein Duox-Relais zu aktivieren, *(fragen Sie Ihren Installateur)*.

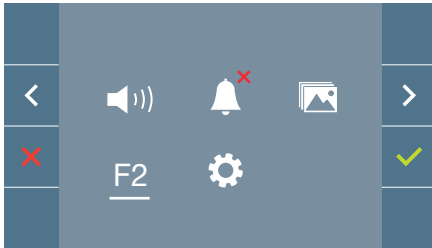

4.5 BENUTZERMENÜ: BENUTZEREINSTELLUNGEN

Durch die Auswahl der Option „Benutzereinstellungen“ im Benutzermenü, gelangt man zu einem neuen Bildschirm mit den entsprechenden Einstellungen:

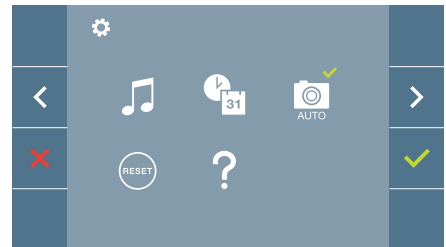
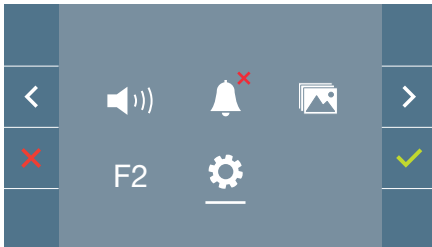

Es gibt die folgenden Einstellungen:

1. Melodieauswahl
2. Datum und Uhrzeit
3. Aktivierung/Deaktivierung der Bildaufzeichnung
4. Reset der Einstellungen
5. Benutzerhilfe

4.5.1 Benutzereinstellungen: MELODIEAUSWAHL

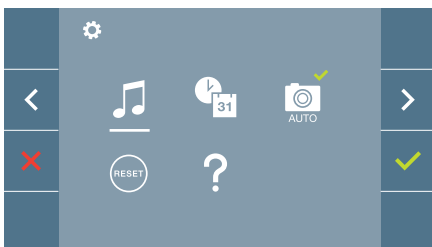

Der Monitor ermöglicht es Ihnen, eine separate Melodie für die Türstationen und die Pförtnerereinheit auszuwählen. Die Türstationen sind:

- Türstation 0 mit Monitor am Block.
- Türstation 1 mit Monitor am Block.
- Türstation 0 am Haupteingang.

Man kann zwischen 5 verschiedenen Melodien wählen.

a) Melodieauswahl Türstation

Türstation 0 mit Monitor am Block

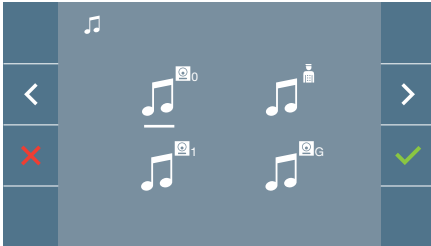

Wenn Sie diese Option wählen, können Sie die Melodie ändern, die auf dem Monitor zu hören ist, wenn ein Anruf von der Türstation im Aussenbereich 0 des Monitors am Block aus erfolgt.

Türstation 1 mit Monitor am Block

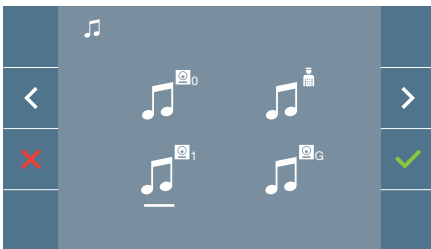

Wenn Sie diese Option wählen, können Sie die Melodie ändern, die auf dem Monitor zu hören ist, wenn ein Anruf von der Türstation im Aussenbereich 1 des Monitors am Block aus erfolgt.

Türstation 0 am Haupteingang

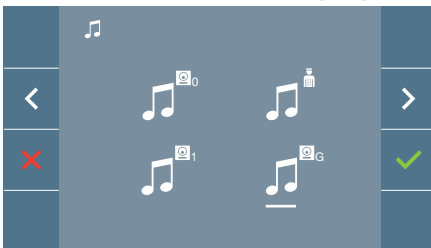

Wenn Sie diese Option wählen, können Sie die Melodie ändern, die auf dem Monitor zu hören ist, wenn ein Anruf über die Türstation im Aussenbereich 0 des Haupteingangs erfolgt.

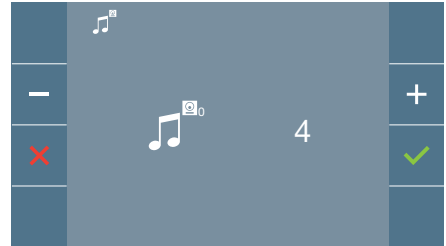

Wenn eine Option ausgewählt wurde, ertönt und erscheint die aktuelle Melodie. Durch Drücken der Taste + oder - können die verschiedenen Melodien ausgewählt und angehört werden.

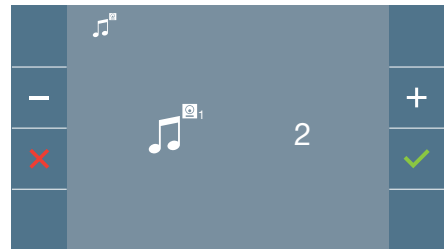

Wenn eine Option ausgewählt wurde, ertönt und erscheint die aktuelle Melodie. Durch Drücken der Taste + oder - können die verschiedenen Melodien ausgewählt und angehört werden.

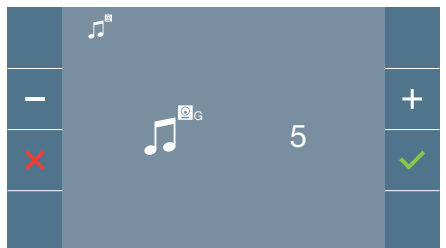

Wenn eine Option ausgewählt wurde, ertönt und erscheint die aktuelle Melodie. Durch Drücken der Taste + oder - können die verschiedenen Melodien ausgewählt und angehört werden.

b) Melodieauswahl Pfortnerzentrale

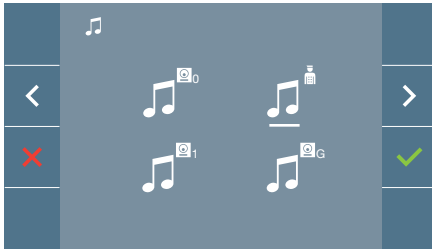

Mit dieser Option, lässt sich die Melodie ändern, die auf dem Monitor zu hören ist, wenn die Pfortnerzentrale auf dem Monitor anruft.

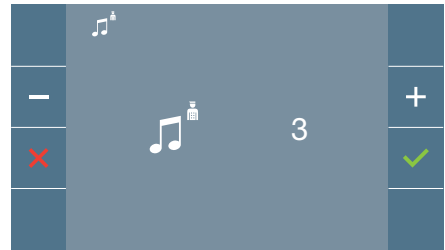

Wenn eine Option ausgewählt wurde, ertönt und erscheint die aktuelle Melodie. Durch Drücken der Taste + oder - können die verschiedenen Melodien ausgewählt und angehört werden.

4.5.2 Benutzereinstellungen: DATUM UND UHRZEIT

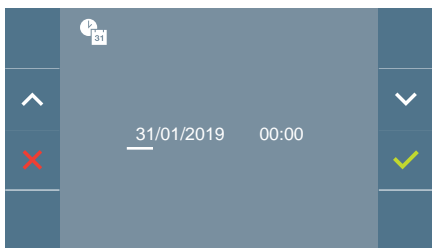
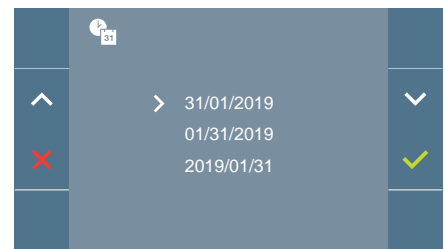
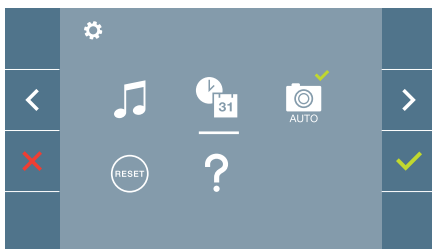

Der Monitor ermöglicht die Einstellung von Datum und Uhrzeit. Über die Navigationssymbole kann man die Datum- und Uhrzeiteinstellungen ändern und durch diese navigieren. Durch Drücken der Taste ✓ wird die Auswahl bestätigt.

Wenn aus irgendeinem Grund die Stromversorgung ausfällt, werden Datum und Uhrzeit auf Werkseinstellung (01/01/2019). zurückgesetzt. Auf dem Monitor erscheint im Benutzermenü und auf dem Videobildschirm ein Symbol, welches anzeigt, dass das Datum nicht korrekt ist.

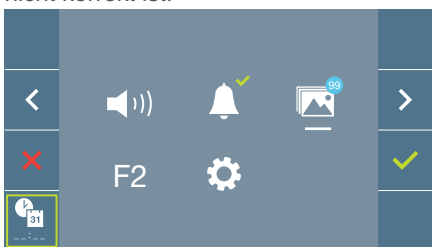

Hinweise:

- Die Einstellung von falschen Angaben von Datum und Uhrzeit sind nicht gestattet.
- Hält man die Navigationstasten  -  gedrückt, ändern sich die Zahlen schneller.

4.5.3 Benutzereinstellungen: **AKTIVIERUNG/DEAKTIVIERUNG DER BILDAUFZEICHNUNG**

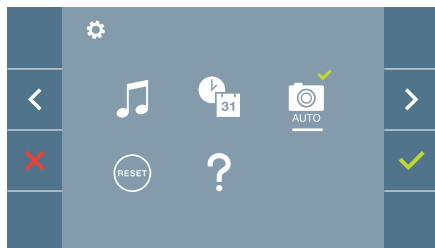
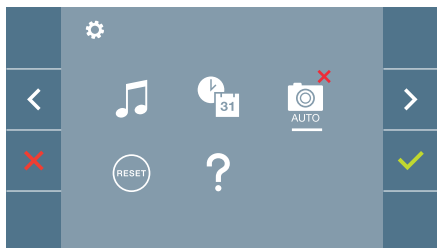

Mithilfe dieser Option kann man die automatische Bildaufzeichnung aktivieren/deaktivieren. Wählen Sie das Symbol für Bildaufzeichnung und drücken Sie die Bestätigungstaste  zum aktivieren/deaktivieren.

Der Monitor kann 3 Sekunden nach Anrufeingang von einer Türstation automatisch ein Bild aufnehmen. Aufgrund der Datenschutzverordnung (EU 2016/679) der Europäischen Union kann die Aufnahme von Bildern eingeschränkt werden. Im Auslieferungszustand ist diese Funktion deaktiviert, kann aber auf eigene Verantwortung aktiviert werden.

Ebenfalls könnte diese Verordnung zwingend vorschreiben, dass ein Warnschild neben der Türstation zu platzieren ist, welches auf die Bildspeicherfunktion des Monitors hinweist.

Ein solches Musterschild können Sie sich von <https://www.fermax.com/intl/de/pro/online-support.html> downloaden.

4.5.4 Benutzereinstellungen: **BENUTZER-RESET**

Mit dieser Option können alle Einstellungen auf Werkseinstellung zurückgesetzt werden, wobei die im Monitor programmierte Adresse beibehalten wird. Option auswählen und bestätigen.

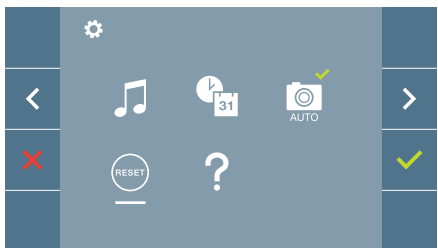

Bestätigen, wenn das Reset erfolgen soll.

4.5.5 Benutzereinstellungen: HILFE

Auf dem Bildschirm wird ein QR-Code angezeigt, der zu einem Werbelink führt, auf dem im Detail das digitale DUOX-System von FERMAX erklärt wird.

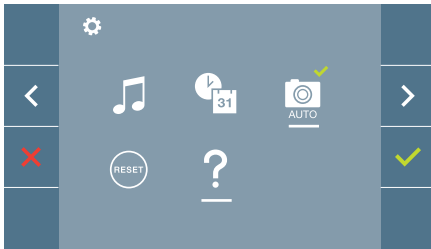

5. EINSTELLUNGEN: VIDEO UND AUDIO

5.1 EINSTELLUNGEN: EINSTELLUNG VIDEO: HELLIGKEIT - KONTRAST - FARBE

Während eines Anrufs oder einer Auto-Einschaltung (📷) (Kamera) lassen sich Helligkeit, Kontrast und Farbe einstellen (ohne die Kommunikation zu starten). *Siehe Kapitel Funktionsweise: Auto-Einschaltung.*

Wenn das Videobild auf dem Bildschirm angezeigt wird, ist die Taste (☐) (Menü) kurz zu drücken und es erscheint auf dem Bildschirm ein Kontextmenü zur Einstellung von Helligkeit, Kontrast und Farbe.

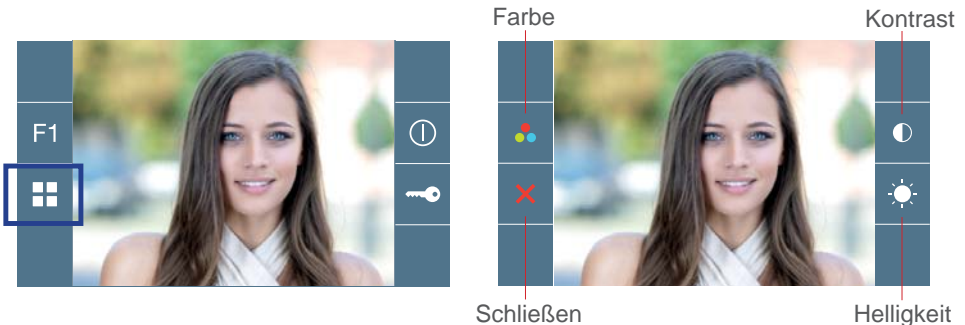

1. Wählen Sie die Einstellungen für Kontrast, Helligkeit und Farbe mit den entsprechenden Tasten.

Von dieser Bildschirmanzeige kann auch die Lautstärke aktiviert werden (bei aktiver Kommunikation).

Hinweis: Die Dauer für die Durchführung der Videoeinstellungen beträgt 30 Sekunden, danach kehrt der Monitor in den Ruhezustand zurück.

Nota: El tiempo para realizar los Ajustes de Video es de 30 segundos, transcurrido este tiempo el monitor volverá a reposo.

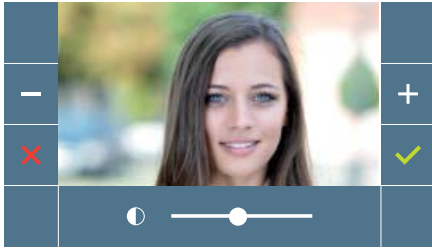

kontrast

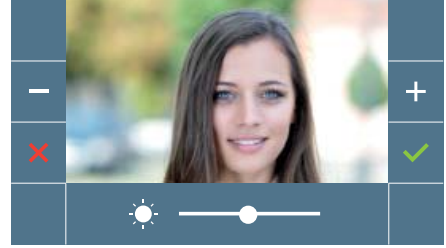

helligkeit

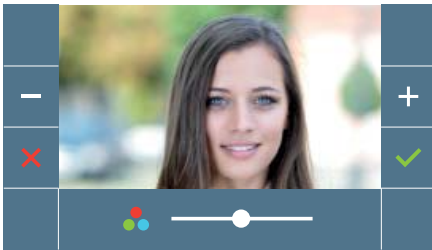

farbe

5.2 EINSTELLUNGEN: AUDIOEINSTELLUNGEN

Während der Audiokanal geöffnet ist, kann die Lautstärke reguliert werden. Für die Audioeinstellung drücken Sie die Taste  (Menü) und es erscheint auf dem Bildschirm ein Kontextmenü für die diese Einstellung.

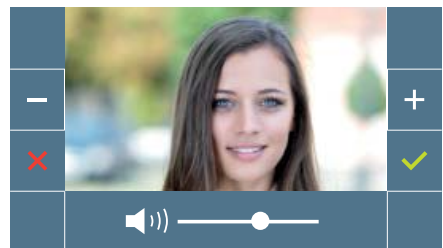

 Benutzerhandbuch: FUNKTIONSWEISE



FUNKTIONSWEISE

1. FUNKTIONSWEISE: ANRUFENTGEGENNAHME. Anruf entgegennehmen.

Durch Drücken der Ruftaste an der **Türstation**, ertönt auf dieser und auf dem Monitor ein Rufton und der Bildschirm schaltet sich ein. Man hat 30 Sekunden zur Entgegennahme, bevor der Ruhezustand zurückkehrt. Innerhalb dieser Zeit erlischt die rote LED, um anzuzeigen, dass ein Anruf eingeht.

Man kann den Hörer abheben und dabei ein Gespräch mit der Türstation aufrecht erhalten. Die Rufverbindung endet automatisch nach 90 Sekunden oder jederzeit durch auflegen des Telefons.

Hinweise:

- Gibt es mehrere Monitore/Telefone in derselben Wohnung, entsteht das Audiosignal für denjenigen, der als erstes abnimmt, wobei die restlichen Monitore/Telefone in den Ruhezustand zurückkehren. Wenn an einem anderen Gerät abgenommen wird, ertönt ein Besetztton.
- Falls keine Sprechverbindung (bei Abheben des Hörers) mit der Türstation hergestellt wird, schaltet sich der Monitor nach Ablauf von 30 Sekunden automatisch aus.

Wenn ein Anruf von der Türstation eingeht, kann jederzeit die Tür durch Drücken der Taste  geöffnet werden.

1.1 Videoanruf.

Für den Fall, dass das Haus einen Anruf von einer Videotürstation erhält, zeigt der Monitor das von der Kamera aufgenommene Video auf der Türstation im Außenbereich an.

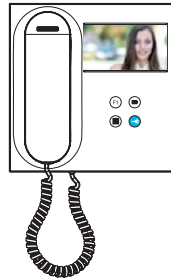

1.2 Audioanruf.

Für den Fall, dass das Haus einen Anruf von einer Audio-Türstation erhält, zeigt der Monitor den folgenden Bildschirm an:

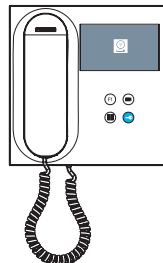

1.3 Rufen Sie den Pförtner an.

Wenn ein Monitor im MIXED-Modus oder TAG-Modus konfiguriert ist, wird durch Drücken der Türöffnertaste im Standby ein Anruf an die letzte Pförtnerereinheit eingeleitet, die ihn in diesem Modus konfiguriert hat. Auf dem Monitorbildschirm wird das folgende Bild angezeigt und ein KLINGELTON ertönt.

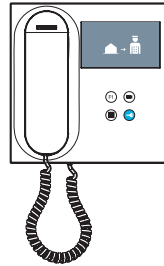

Wenn Sie einen Anruf vom Pförtner auf dem Heimmonitor erhalten, wird das folgende Bild angezeigt:

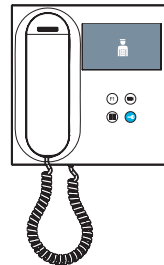
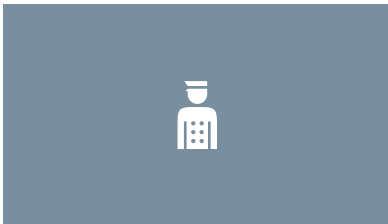

2. FUNKTIONSWEISE: MANUELLE AKTIVIERUNG DES MONITORS (AUTO POWER)

Wenn sich der Monitor im Standby-Modus befindet, drücken Sie die Taste  (Kamera), um den Monitor manuell einzuschalten.

Alle Vorschau-Timings ohne Audio (30sec) oder Gespräch (90sec), werden auch über die Kamera geändert.

Automatisches Einschalten im Standby:

1. Wenn der vorherige Anruf von der Türstation vor weniger als 15 Sekunden beendet wurde, wird die Türstation erneut angewählt: **R**.



2. Wenn der vorherige Fall nicht eintritt, beginnt das automatische Einschalten mit den verschiedenen Türstationen, die auf dem Monitor sichtbar sind.

Drücken Sie nacheinander Türstation 0, Türstation 1, HauptTürstation (je nach Verfügbarkeit der Türstationen).

- 1 Türstation 0 oder Kamera 0 mit Monitor am Block.
- 2 Türstation 1 oder Kamera 1 mit Monitor am Block.
- 3 Türstation 0 oder Kamera 0 am Haupteingang.

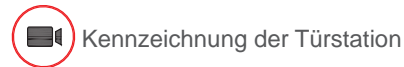

Sobald die Kommunikation mit einer Türstation hergestellt ist, kann sie durch Drücken der Taste  (*Kamera*) geändert werden.

Automatisches Einschalten bei eingehendem Anruf:

1. Wenn der Anruf einer Türstation der im vorherigen Punkt beschriebenen Sequenz entspricht, wird das automatische Einschalten auf der nächsten Türstation der Sequenz fortgesetzt.
2. Wenn der Anruf NICHT von einer Türstation aus erfolgt, beginnen Sie den Autostart mit der Türstation 0 des Blocks (je nach Verfügbarkeit der Türstation und folgen Sie der Reihenfolge:



- 1 Türstation 0 oder Kamera 0 mit Monitor am Block



- 2 Türstation 1 oder Kamera 1 mit Monitor am Block



- 3 Türstation 0 oder Kamera 0 am Haupteingang

Hinweise:

- Das automatische Einschalten kann nur mit den angegebenen Türstationen durchgeführt werden. Wenn Sie das automatische Einschalten nicht durchführen können, wenden Sie sich an Ihren Installateur. Wenn nach Abschluss der Verbindungsversuche mit jeder der drei möglichen Türstationen keine Verbindung besteht, gibt der Monitor einen Fehlerton aus und kehrt in den Ruhezustand zurück.
- Wird am Ende jeder Kommunikation mit einer Türstation innerhalb von 15 Sekunden der Autostart-Taster erneut gedrückt, wird eine Verbindung mit dieser Türstation hergestellt.
- Bei automatischem Einschalten ohne Audio und Öffnen der Tür innerhalb von 5 Sekunden, wird der Anruf beendet.
- Wird an einem zweiten Monitor ein Autostart durchgeführt, lassen sich mehrere Fälle unterscheiden:
 - o Der erste Monitor ist automatisch eingeschaltet und führt kein Gespräch mit Audio: In diesem Fall ist das automatische Einschalten des zweiten Monitors nicht zulässig.
 - o Der erste Monitor hat einen Autostart durchgeführt und ein Audio-Gespräch aufgebaut: Das Autostart-Setup darf gestartet werden.
 - o Auf jeden Fall darf der zweite Monitor am Ende des Gesprächs oder beim Autostart mit Video nur vom ersten Monitor aus den Autostart starten.

3. FUNKTIONSWEISE: ANZEIGE VON BILDERN

Funktion, um alle aufgenommenen Bilder zu sehen. Die Funktion für die Bildaufnahme muss zuvor aktiviert sein. [Siehe Kapitel 4.5 BENUTZERMENÜ - 4.5.3 Aktivierung/Deaktivierung von Bildern.](#)

Erfolgt ein Anruf von der Türstation, (Die Funktion für die Bildaufnahme muss zuvor aktiviert sein) wird nach 3 Sekunden automatisch ein Foto aufgenommen und gespeichert.

Hinweis: Es können maximal 150 Bilder gespeichert werden. Wird ein neues Bild bei vollem Speicher aufgenommen, wird das älteste Bild gelöscht

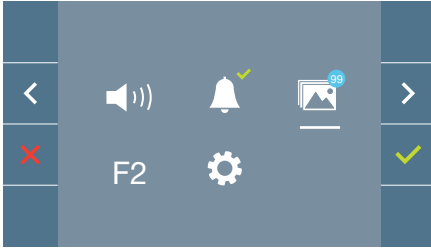





Wählen Sie die Taste  aus, um die einzelnen Fotos anzuzeigen.





Das neueste Bild wird mit dem Datum, der Uhrzeit und der Bildnummer angezeigt.

Es erscheint ein Kontextmenü:

-   :Auswählen/Anzeigen von gespeicherten Fotos.
-  : Löschen von Fotos.
-  : Schließen und zum vorherigen Bildschirm.



Wenn die Option Löschen  gedrückt wird, erscheint das Bestätigungsfenster und beim Drücken der Bestätigungstaste  wird das ausgewählte Foto gelöscht. Der Benutzer kann auch dann durch die Fotos navigieren, wenn das Bestätigungsfenster geöffnet ist.

Hinweis: Wenn Sie das Bestätigungssymbol für 5 Sekunden  gedrückt halten, können alle Bilder nach Bestätigung gelöscht werden.

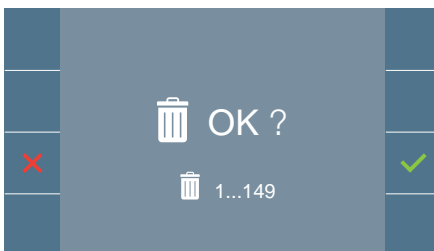

Falls es gespeicherte Bilder gibt, die noch nicht durch den Benutzer angesehen wurden, erscheinen Meldungen auf dem Symbol des Benutzermenüs und des Videobildschirms.

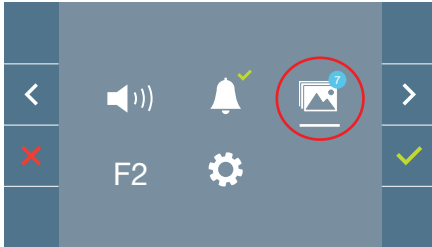

Auf dem Bildanzeige-Symbol erscheint ein blauer Kreis mit der Anzahl der anzuzeigenden Bilder (höchstens 99). Die Anzahl der durch den Benutzer angesehenen Bilder, werden auf dem blauen Kreis abgezogen.



Bei einem Anruft, erfolgt die Benachrichtigung, dass nicht angesehene Fotos bereitstehen, wobei in diesem Fall die Anzahl nicht angezeigt wird.

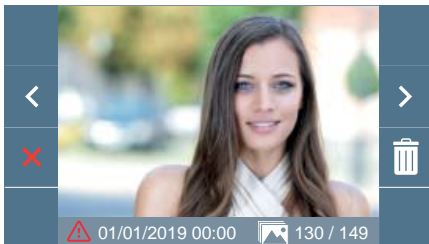

Wenn aus irgendeinem Grund die Stromversorgung ausfällt, werden Datum und Uhrzeit auf Werkseinstellung (01/01/2019) zurückgesetzt.

Wenn ein Foto ohne vorherige Einstellung des Datums und der Uhrzeit gespeichert wird, erscheint dieses Symbol  auf der Bildanzeige und weist darauf hin, dass die Einstellungen von Datum und Uhrzeit nicht korrekt sind.



Das erworbene Gerät fällt unter die Richtlinien 2012/19/EU über Elektro- und Elektronik-Altgeräte. Weitere Information:











PARABÉNS POR TER ADQUIRIDO UM PRODUTO DE QUALIDADE!
A Fermax eletrónica desenvolve e fabrica equipamentos de prestígio que cumprem os padrões mais altos de desenho e tecnologia. Esperamos que desfrute das suas funcionalidades.

*Publicação técnica de carácter informativo editada pela FERMAX ELECTRÓNICA S.A.U.
A FERMAX ELECTRÓNICA, na sua política de melhoria constante, reserva-se o direito a modificar o conteúdo deste documento assim como as características dos produtos nele referidos em qualquer momento e sem aviso prévio. Qualquer modificação será refletida nas posteriores edições deste documento.*

*Este produto está protegido com as seguintes patentes e modelos de utilidade:
PATENTES: US 9215410, US 9762852, BE1023440, AU2014203706.
MODELOS DE UTILIDADE: ES1187384U, ES1141495U, FR3038192, DE202016000632U1, CN205987229(U).*

Cod. 970159 V04_19

ÍNDICE

	INTRODUÇÃO	4
	INSTALAÇÃO	5
	-Instalação monitor	5
	-Conexões	6
	CARACTERÍSTICAS TÉCNICAS	8
	DESCRIÇÃO DO PRODUTO	9
	- Botões	9
	- Led	10
	- Ciclo indutivo	10
	PROGRAMAÇÃO	10
	1. Aceder ao menu de administrador e de usuário	10
	2. Botões de navegação e botões do monitor	12
	3. Menu administrador	12
	1. Programação direção monitor	12
	2. Reset/reinicialização de parâmetros	15
	3. Sobre	15
	4. Menu usuário	15
	1. Ajuste de volume	16
	2. Função não incomodar	16
	3. Visualizar imagens	16
	4. Função F2	17
	5. Ajustes de parâmetros de usuário	17
	5. Ajustes de vídeo e áudio	21
	FUNCIONAMENTO	23
	1. Atender uma chamada	24
	2. Ativação manual do monitor (ligação automática)	25
	3. Visualização de imagens	27



INTRODUÇÃO

O monitor VEO DUOX incorpora a tecnologia DUOX de áudio e vídeo, alimentação e dados através de dois fios não polarizados.

As características fundamentais do sistema DUOX são as seguintes:

- Alimentação dos monitores através de bus de 18 Vdc / 24 Vdc.
- Segredo de conversa.
- Bus não polarizado.

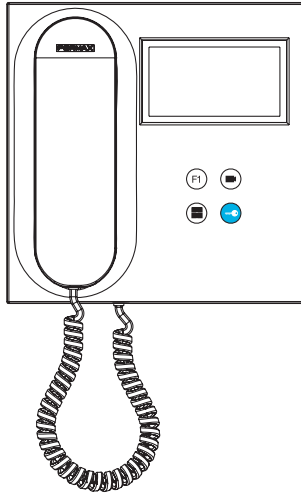

FUNCIONALIDADES

As funções disponíveis no monitor VEO DUOX são resumidas na seguinte lista:

- Abertura de porta.
- Chamada ao porteiro.
- Regulação de volume de chamada.
- Desconexão de chamada (Não incomodar).
- Seleção de melodias.
- Campainha da porta
- Programação a partir da botoneira, monitor e campainha da porta.
- Regulação de volume de áudio.
- Configuração de parâmetros por menu no ecrã (OSD).
- Ajustes de brilho, contraste e cor.
- Funções auxiliares F1 e F2.
- Ciclo indutivo (*dependendo do modelo*).
- Captura de imagens (*com memória*).

✕ INSTALAÇÃO

INSTALAÇÃO MONITOR

Conector

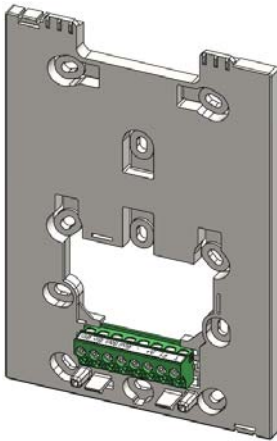

Cablagem de superfície

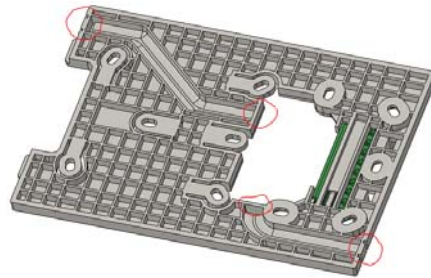

Para instalações não incorporadas, o conector tem dois canais para guiar os cabos para a faixa de ligação a partir do chão ou do teto. Duas das divisórias marcadas devem ser removidas com um alicate de corte para permitir o acesso aos cabos a partir da parte inferior ou superior do conector.

Montagem do monitor

1

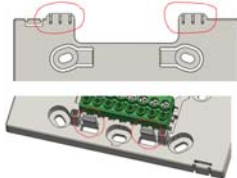

O monitor fica pendurado nos dois ganchos superiores do conector, sendo afixado ao mesmo com dois cliques localizados na área inferior.

2

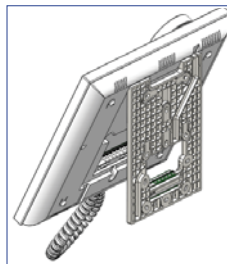
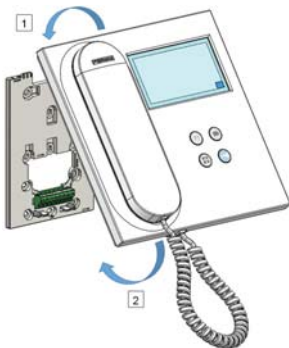

A figura seguinte mostra o monitor durante a suspensão no conector antes de o dobrar para baixo para completar a montagem.

Coloque o monitor na frente do conector num ângulo entre 15 e 30 graus, pendurando-o nos ganchos acima mencionados. Dobre o monitor sobre o conector exercendo força em direção à parede em ambos os lados da extremidade inferior até ouvir ou notar que as crimpagens inferiores estão fechadas.

3



Para posicionar o monitor e reforçar a retenção, o conector tem duas guias localizadas em ambos os lados dos engastes.

Desmontagem do monitor

a

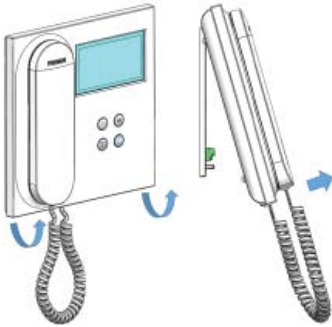

a) Instalado na parede

O conector foi desenhado para desmontar o monitor sem a necessidade de ferramentas. Para isso, basta puxar os cantos inferiores em direção perpendicular à parede até desbloquear os frisos e atingir um ângulo mínimo com a parede de 10 graus. Depois solte o monitor dos ganchos superiores do conector.

b

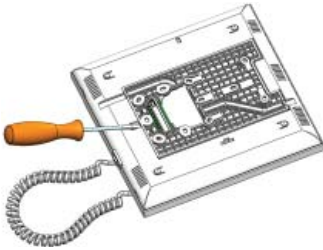

b) Monitor e conector unidos

Se o monitor e o conector estiverem juntos, sem que o conector esteja afixado a uma parede, é necessário utilizar uma chave de fendas plana para fazer de alavanca e separar conforme indicado. .

CONEXÕES

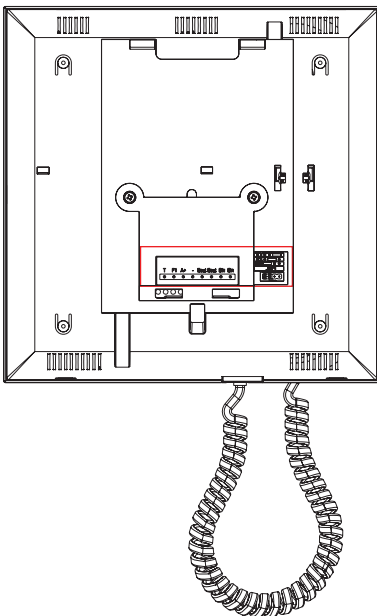

Conectores de monitor:

Bin,Bin: Dados, áudio e vídeo entrada.

Bout,Bout: Dados, áudio e vídeo entrada (*conexão em cascata*).

T, -: Botão de chamada porta vivenda (P1).

A+, -: Possibilidade conexão seguintes equipamentos:

- Prolongador de chamada ref. 2040.
- Ativador de Luzes e campainhas ref. 2438.

F1: Função adicional. (*Saída negativo “-” / envio de comando, ver capítulo Botões: Função auxiliar F1*).

JP1: Ponte adaptador de linha integrado

- Acima: Adaptação tipo A.
- Centro: Adaptação tipo C.
- Abaixo: Sem adaptação de linha: OFF, (pré-definido).

DISTRIBUIÇÃO

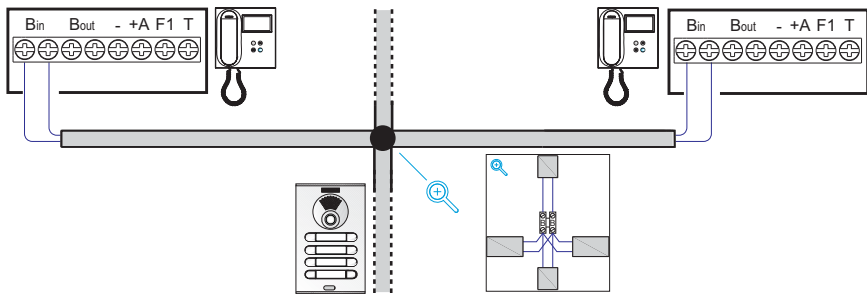

CASCATA

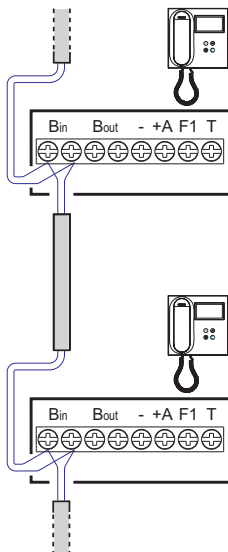

AMPLIAÇÕES:

- Prolongador de chamadas: Ref. 2040
- Campainha da porta: P1

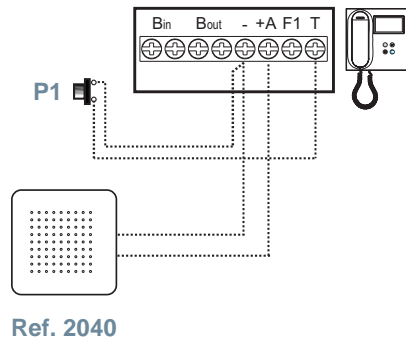

AMPLIAÇÕES: Ativador de luzes e campainhas Ref. 2438

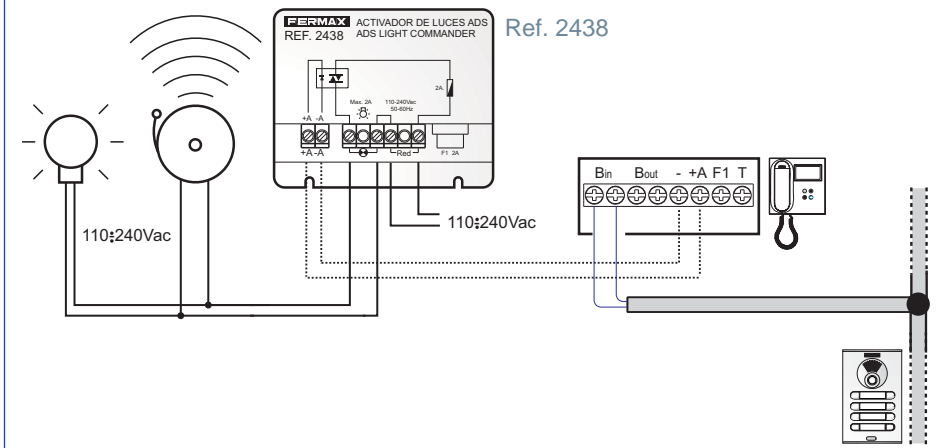

CARACTERÍSTICAS TÉCNICAS

Fonte de alimentação (sem polaridade)	18 - 24 Vdc
Consumo	
Consumo em repouso	0,8 W
Consumo máximo de energia	5,2 W
Número de terminais por vivenda	3
Endereço de cada monitor: 6 dígitos	000001...999999
Temperatura de funcionamento	[-5° , +40°C] / [23° , 104°F]
Humidade	[0% - 90%]
Ecrã OSD	TFT 4.3"
Resolução	
Hor.:	480 Line TV
Ver.:	272 Line TV
Dimensõesmonitor (Altura x Largura x Profundidade)	200 x 200 x 46mm - 8" x 8" x 1.8" x 0.8"

Nota importante: Este monitor VEO é compatível com os monitores VEO e VEO XS com as versões V2.x e V3.x.

Se algum dos monitores das versões indicadas for substituído, o conector do monitor também deverá ser substituído. O conector do monitor de corrente tem a referência 9447.

DESCRIÇÃO DO PRODUTO

Monitor VEO

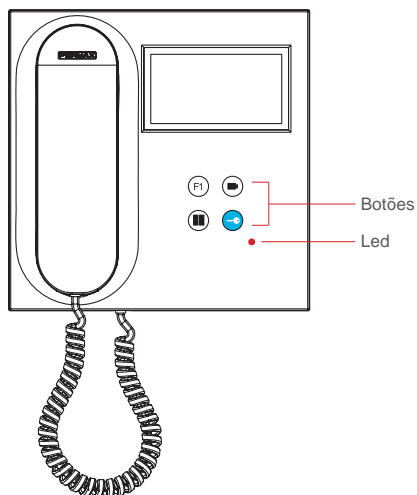

BOTÕES



Botão de trinco / chamada ao porteiro.

- Estando em comunicação com a Botoneira de Ruas (*apenas áudio ou apenas vídeo ou ainda áudio+vídeo*), ao premir este botão ativa-se o trinco.
- Com o braço pendurado (*monitor em repouso*), ao premir este botão realiza-se uma chamada ao porteiro (se existir portaria e o monitor está em modo dia ou misto).



Botão Ligação automática.

Conexão com câmara do Bloco ou da Entrada Geral (*função disponível dependendo do tipo de instalação, ver capítulo **Funcionamento: Ligação automática***).



Função auxiliar F1

Função auxiliar (saída negativo "-" / envio de comando).

Envio de negativo: *Saída de negativo pelo terminal F1 ao premir o botão F1 e também envia um comando F1 de ativação para poder ativar um dispositivo auxiliar.*



Botão Menu.

· Para aceder a:

- **Menu de Programação**, podemos aceder quando o monitor não está programado. A partir deste menu, podemos realizar a programação do monitor dependendo das necessidades da instalação.
- **Menu de Usuário**, (uma vez programado o monitor). A partir deste menu, podemos aceder aos ajustes de usuário para respetiva personalização.

LED

● Led Vermelho:

Intermitente rápido. Monitor por programar.

Intermitente lento. Indica que a função não incomodar está ativada.

Ligado. Monitor em repouso.

Ciclo Indutivo

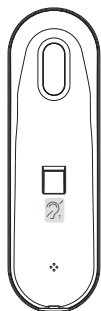

Ciclo indutivo. Vem identificado com este rótulo (*dependendo do modelo*). Existe um modelo do monitor VEO com ciclo indutivo no braço do monitor. [Ver 97507 Braço Telefone ciclo indutivo em www.fermax.com.](http://www.fermax.com)

- Inclui um ciclo que interatua com os dispositivos de audição de pessoas com incapacidade auditiva.

Nota: Em dispositivos de audição com seleção manual de modo, deve estar configurado o Modo Digital.



PROGRAMAÇÃO:

1. PROGRAMAÇÃO: ACEDER AO MENU DE ADMINISTRADOR E DE USUÁRIO

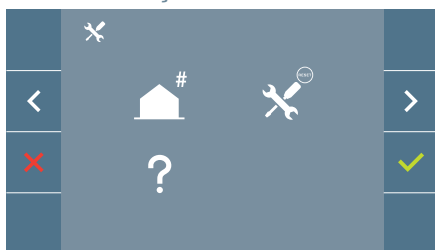

Ecrã: Menu ADMINISTRADOR

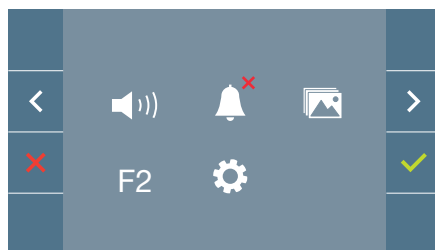

Ecrã: Menu USUÁRIO

Os ícones de Não Incomodar (*Ecrã: Menu Usuário*) e Captura de Imagem (*Ecrã Menu Usuário. Opção Parâmetros de usuário*) vão mudar dependendo de se estão ativados/desativados. Se estiverem ativados vai aparecer um tick verde ✓ na parte superior direita do ícone, enquanto que se estiverem desativados vai aparecer uma cruz vermelha ✗.

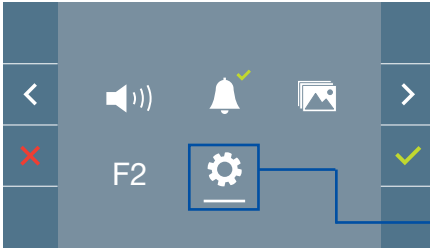

Ecrã: Menu USUÁRIO

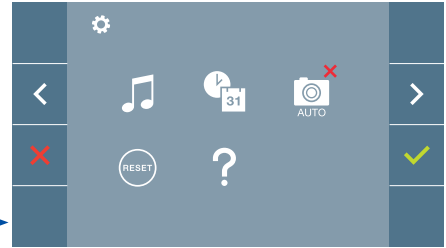

Ecrã: Opção Parâmetros de usuário do Menu USUÁRIO.

Premindo o botão  **MENU**, podemos aceder diretamente:

- À opção de Programação do monitor do Menu de Administrador, se o monitor não estiver programado.
- Ao ecrã do Menu de Usuário, se o monitor estiver programado.

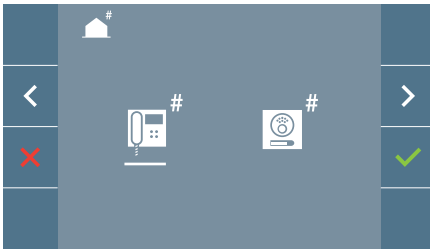

Ecrã: Opção Programação do monitor do Menu ADMINISTRADOR.

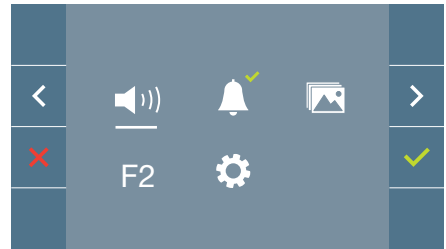

Ecrã: Menu USUÁRIO

Para aceder ao Menu de Administrador quando o monitor está programado será necessário realizar dois passos:

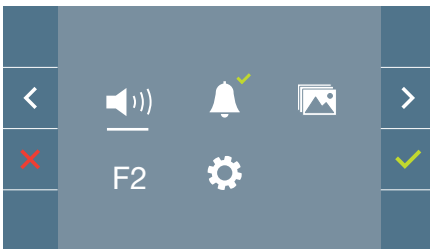

1. Premir o botão  **MENU**, para aceder ao ecrã do **Menu de Usuário**.



2. Estando no ecrã do Menu de Usuário, premir simultaneamente os botões:



2. PROGRAMAÇÃO: BOTÕES DE NAVEGAÇÃO E BOTÕES DO MONITOR



Os ícones visualizados no ecrã (*botões de navegação*: , , e), sendo manuseado com os botões correspondentes localizados no monitor:

- : Voltamos ao ecrã anterior ou stand-by.
- : Seleccionamos a opção prévia do menu.
- : Marcamos a seguinte opção do menu.
- : Confirma a seleção e ativa a função.

Notas:

- A linha branca debaixo do ícone indica a função em que nos encontramos. Ao premir, seleccionamos.
- O monitor sai da programação automaticamente, após 60 segundos de inatividade.

3. PROGRAMAÇÃO: Ecrã MENU ADMINISTRADOR

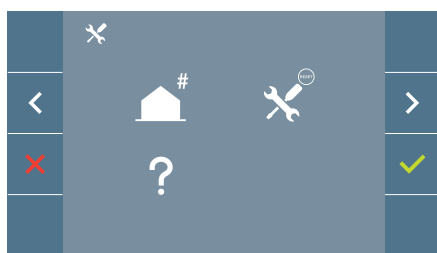

Existem várias opções:

1. Programação da direção do Monitor.
2. Reset/reinicialização de parâmetros
3. Sobre.

3.1 MENU ADMINISTRADOR: PROGRAMAÇÃO direção monitor

O monitor não funciona enquanto não tiver sido programado!

Nota: O led vermelho a piscar lentamente indica que o monitor está por programar e quando a direção do monitor tiver sido programada o led vermelho apaga.

Existem três opções para programar o monitor a partir de:

- A) A partir do Monitor.
- B) A partir da Botoneira.
- C) A partir da Campainha da porta.

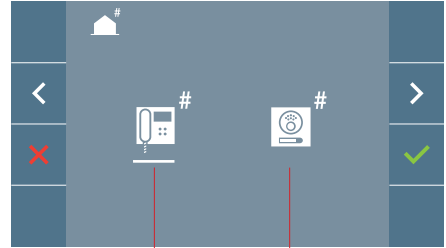



A partir do Monitor A partir da Botoneira

A) A partir do Monitor.

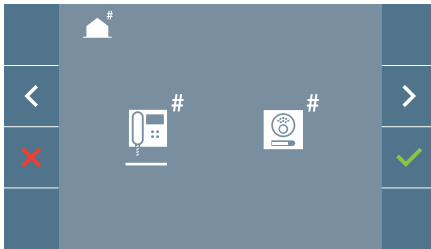
É possível programar o monitor no ecrã através do menu.



Programar o número de chamada: Premir  no ecrã e aceder o ecrã para programar o número de vivenda (*números da direita para a esquerda*).

Cada vez que se pressionar o **+** incrementa o número (*começando pelo 1*) e a **flecha** utiliza-se para o deslocamento. Um cursor branco indica a posição de introdução do dígito. Programar o número correspondente e aceitar com . Uma vez programada a direção do monitor indica-se através do led vermelho fixo.

B) A partir da Botoneira.

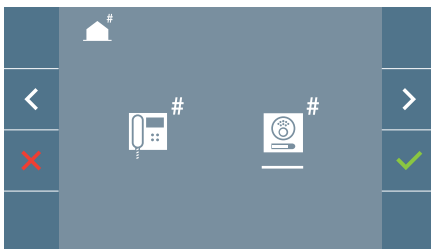

Opção selecionada através da linha branca situada abaixo do ícone. Premir , ouve-se um bip no monitor.

O monitor conecta-se automaticamente à botoneira de rua ativando a câmara. Introduzir o código de chamada para esse monitor a partir da botoneira. Dependendo do tipo da botoneira instalada:

- Premindo o botão correspondente
- Introduzindo o código + sino.

Notas:

- O tempo transcorrido desde que se ouve o bip de confirmação de entrada em programação do monitor e se produz a chamada a partir da botoneira para programar a direção do monitor, deve ser inferior a 2 minutos e meio.
- A botoneira a partir da qual se realiza a programação deve estar como botoneira mestre ou principal.

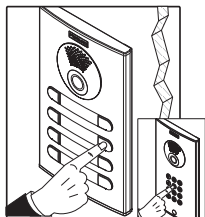
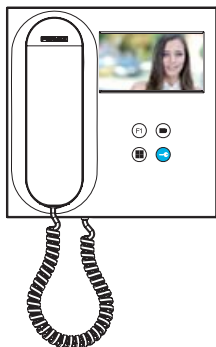

Produz-se um tom de chamada diferente, confirmando a programação do monitor continuando a visualizar-se a imagem da câmara. Transcorridos alguns segundos o monitor volta ao modo repouso. Uma vez programada a direção do monitor indica-se através do led vermelho fixo.

C) A partir da Campainha da porta.

Através da entrada da campainha da porta T e - também se pode programar a direção do monitor.

Para poder realizar este tipo de programação, o monitor não deve estar previamente programado .

Premir a campainha da porta durante 5 segundos, ouve-se o bip de confirmação de entrada na programação do monitor.

O monitor conecta-se automaticamente à botoneira de rua ativando a câmara. Introduzir o código de chamada para esse monitor a partir da botoneira, dependendo do tipo de botoneira instalada.

- Premindo o botão correspondente.
- Introduzindo o código + sino.

Produz-se um tom de chamada diferente, confirmando a programação do monitor continuando a visualizar-se a imagem da câmara. Transcorridos alguns segundos o monitor volta ao modo repouso. Uma vez programada a direção do monitor indica-se através do led vermelho fixo.

Notas:

- O tempo transcorrido desde que se ouve o bip de confirmação de entrada em programação do monitor e se produz a chamada a partir da botoneira para programar a direção do monitor, deve ser inferior a 2 minutos e meio.
- A botoneira a partir da qual se realiza a programação deve estar como botoneira mestre ou principal.

3.2 MENU ADMINISTRADOR: **RESET /REINICIALIZAÇÃO DE PARÂMETROS**

O instalador pode reinicializar os parâmetros para deixar o monitor com a configuração padrão, selecionando e confirmando a opção.

A reinicialização afeta tanto os parâmetros de configuração do usuário como a direção do monitor.



Nota: O led vermelho a piscar rapidamente indica que o monitor está por programar. Como o reset/reinicialização apaga a direção do monitor programada, quando o led estiver a piscar indica que o reset/reinicialização já terminou.

3.3 MENU ADMINISTRADOR: **SOBRE**

No ecrã mostra-se um código QR que permite aceder à documentação completa do monitor.



4. PROGRAMAÇÃO: **Ecrã MENU USUÁRIO**

Premindo o botão  MENU, acedemos diretamente ao ecrã do Menu de Usuário se o monitor estiver programado.

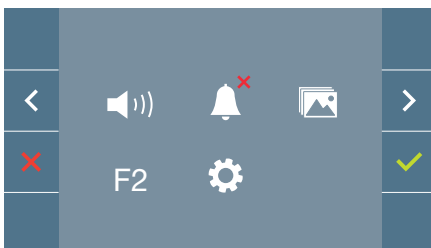

Existem várias opções:

1. Ajuste de volume do monitor
2. Função não incomodar
3. Visualizar imagens
4. Função F2
5. Ajustes parâmetros de usuário

4.1 MENU USUÁRIO: AJUSTE DO VOLUME DO MONITOR

É possível ajustar o volume de melodia numa faixa de dez valores possíveis.

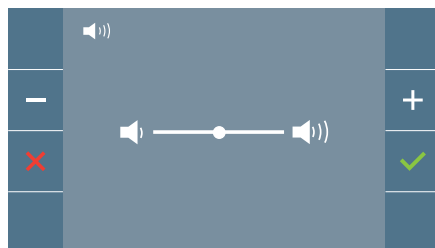
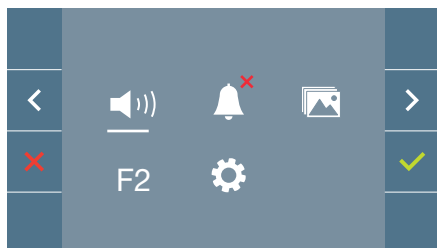

Em primeiro lugar mostra-se e ouve-se o volume atual que poderá ir aumentando (+) ou diminuindo (-) com os botões correspondentes. Através dos mesmos podemos obter a regulação desejada.

4.2 MENU USUÁRIO: MODO NÃO INCOMODAR

Neste ícone podemos ativar/desativar o tom de chamada (*modo não incomodar*).

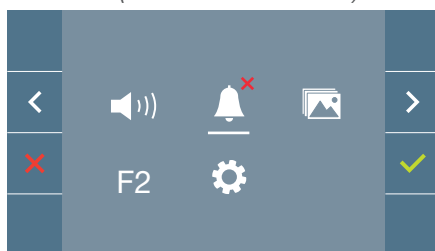
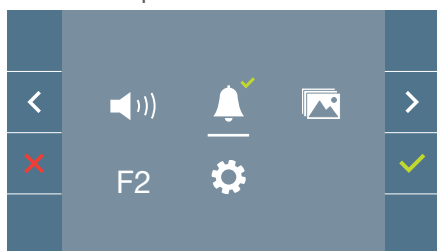

Premir o ícone ✓ para alterar a seleção. Por padrão está selecionado o funcionamento normal (*ouve-se a chamada*).

O led vermelho do monitor pisca lentamente quando o modo não incomodar está ativo.

4.3 MENU USUÁRIO: VISUALIZAR IMAGENS

A partir deste ícone podemos visualizar as imagens capturadas automaticamente e apagá-las. Para mais informação [ver capítulo Funcionamento: Visualização de imagens.](#)

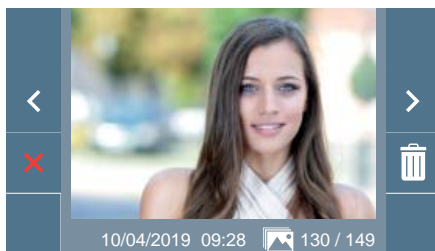
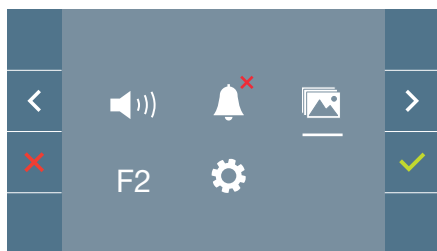

4.4 MENU USUÁRIO: FUNÇÃO F2

A função F2 envia um comando de ativação para poder ativar um dispositivo auxiliar.

A ação será notificada no ecrã: F2 ON durante 3 segundos. Esta função está no ecrã principal do menu do usuário.

O comando F2 é enviado por bus incluindo a direção do monitor para ativar o dispositivo auxiliar conectado ao bus como por exemplo um relé duox, (*consulte o seu instalador*).



4.5 MENU USUÁRIO: AJUSTES PARÂMETROS DE USUÁRIO

No menu de usuário, ao selecionar a opção «Ajustes parâmetros de usuário», acedemos a um novo ecrã correspondente a diferentes parâmetros de configuração:

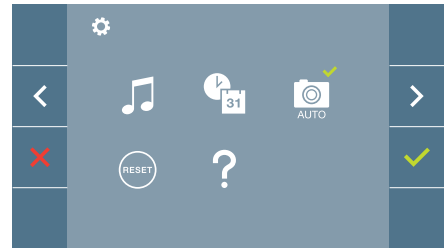
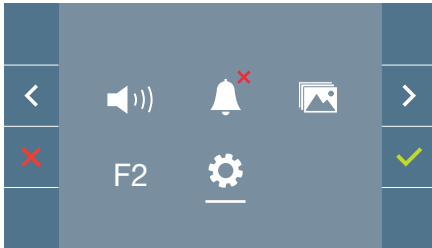

Os parâmetros são os seguintes:

1. Seleção de melodias
2. Ajuste data e hora
3. Ativação/Desativação Captura de imagens
4. Reset/reinicialização dos parâmetros de configuração
5. Ajuda de usuário

4.5.1 Ajustes parâmetros de usuário: SELEÇÃO DE MELODIAS

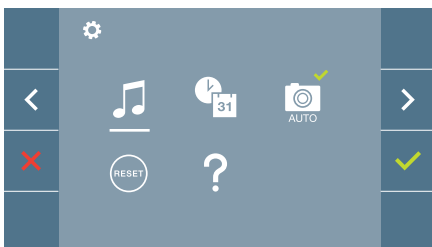

O monitor permite selecionar uma melodia separada para as botoneiras e para a portaria. As botoneiras são:

- Botoneira 0 de Bloqueio do monitor.
- Botoneira 1 de Bloqueio do monitor.
- Botoneira 0 da Entrada Geral.

Permite atribuir entre 5 tons diferentes de melodias.

a) Seleção melodia botoneira

Botoneira 0 do Bloco do monitor

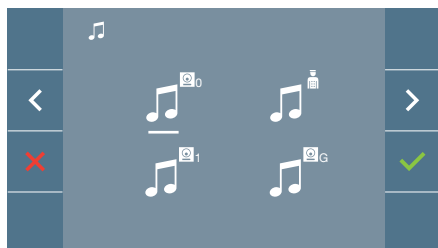

Selecionando esta opção, podemos alterar a melodia que se vai ouvir no monitor quando se realizar uma chamada a partir da botoneira de rua 0 do bloco do monitor.

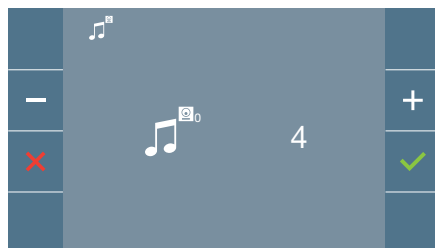

Uma vez seleccionada a opção, mostra e ouve-se a melodia atual, premindo o botão + ou - podemos ir seleccionando e ouvindo as diferentes melodias disponíveis no monitor.

Botoneira 1 do Bloco do monitor

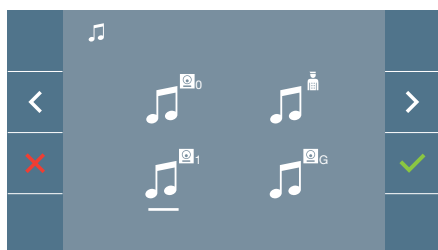

Selecionando esta opção, podemos alterar a melodia que se vai ouvir no monitor quando se realizar uma chamada a partir da botoneira de rua 1 do bloco do monitor.

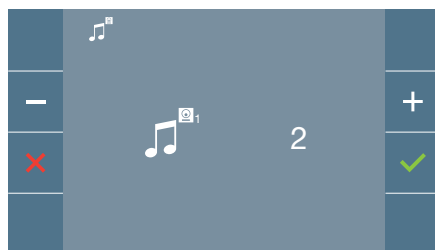

Uma vez seleccionada a opção, mostra e ouve-se a melodia atual, premindo o botão + ou - podemos ir seleccionando e ouvindo as diferentes melodias disponíveis no monitor.

Botoneira 0 da Entrada Geral

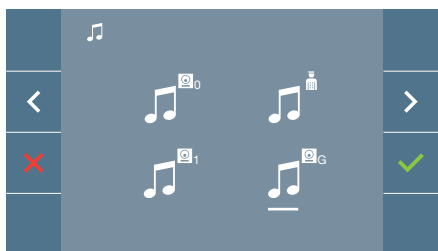

Selecionando esta opção, podemos alterar a melodia que se vai ouvir no monitor quando se realizar uma chamada a partir da botoneira de rua 0 do bloco do monitor.

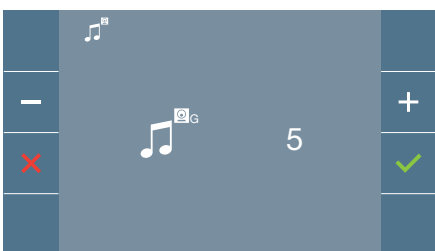

Uma vez seleccionada a opção, mostra e ouve-se a melodia atual, premindo o botão + ou - podemos ir seleccionando e ouvindo as diferentes melodias disponíveis no monitor.

b) Seleção melodia portaria

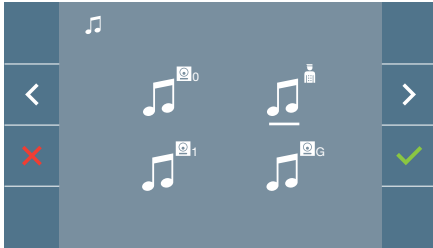

Selecionando esta opção podemos alterar a melodia que se vai ouvir no monitor quando realizar uma chamada a partir da botoneira de rua.

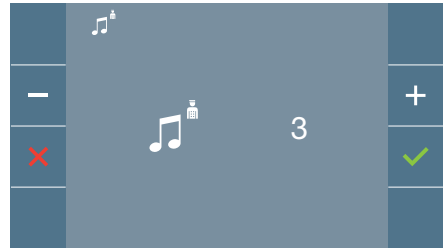

Uma vez selecionada a opção, mostra e ouve-se a melodia atual, premindo o botão + ou - podemos ir seleccionando e ouvindo as diferentes melodias disponíveis no monitor.

4.5.2 Ajustes parâmetros de usuário: AJUSTES DE DATA E HORA

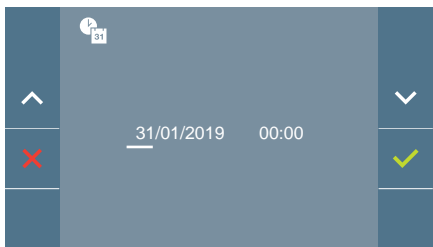
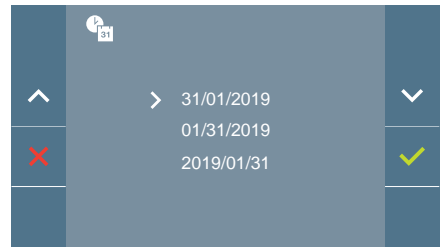
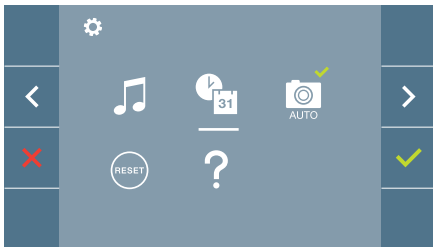

O monitor permite ajustar a data e a hora.

Através dos ícones de navegação podemos alterar os ajustes de data e hora e navegar pelos mesmos. Premir o ícone ✓ para confirmar a seleção.

Se por algum motivo se perder a alimentação, a configuração de data e hora passará a ser a configuração padrão (01/01/2019). No monitor vai aparecer no menu de usuário e no ecrã de vídeo um ícone indicando que a data não está correta.

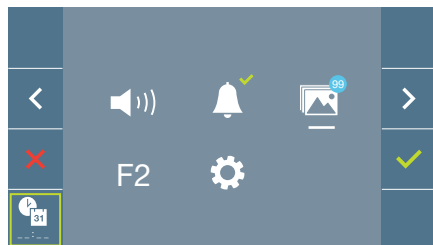

Notas:

- Não se permite validar com dados incorretos de data e hora, sendo sugerida uma data e hora mais próximas.
- Mantendo os ícones de navegação  -  premidos, os números mudam mais depressa.

4.5.3 Ajustes parâmetros de usuário: **ATIVÇÃO/DESATIVÇÃO CAPTURA DE IMAGENS**

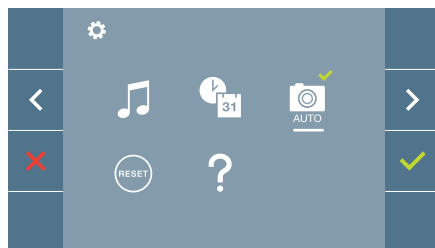
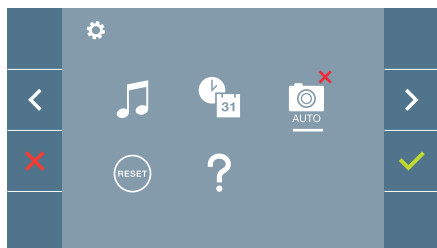

A partir desta opção, podemos ativar/desativar a captura automática de imagens. Selecionar o ícone de captura de imagens e premir confirmar  para ativar/desativar.

O monitor realizará uma fotografia automática passados 3 segundos de ter recebido uma chamada de uma botoneira de rua. Devido à legislação de proteção de dados ((UE) 2016/679) da União Europeia, a captura de imagens pode ser restrita. Por defeito está desativada, podendo ser ativada no monitor por sua conta e risco.

Também obriga a colocar ao lado da placa de rua um aviso indicando que o monitor pode capturar imagens. Pode ser descarregado em <https://www.fermax.com/portugal/corporate/utilidades.html>.

4.5.4 Ajustes parâmetros de usuário: **RESET DE USUÁRIO**

Com esta opção, podemos reinicializar todos os parâmetros de configuração a valores de fábrica, conservando a direção programada no monitor. Selecionando e confirmando a opção.

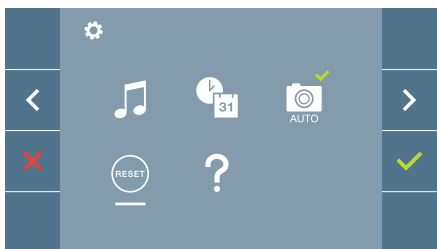

Se se desejar realizar a reinicialização, deverá confirmar a opção.

4.5.5 Ajustes parâmetros de usuário: **AJUDA**

No ecrã aparece um código QR que permite aceder a um enlace promocional que explica pormenorizadamente o sistema digital DUOX criado pela FERMAX.

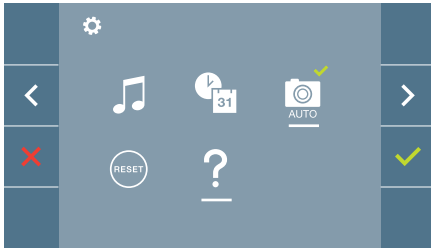

5. AJUSTES: VÍDEO E ÁUDIO

5.1 AJUSTES: AJUSTE VÍDEO: BRILHO - CONTRASTE - COR

O monitor permite realizar os ajustes de brilho, contraste e cor assim que receber uma chamada (*sem iniciar a comunicação*) ou realizando uma ligação automática (📷) (câmara).
 Ver capítulo **Funcionamento: Ligação automática**.

Tendo a imagem de vídeo no ecrã, realizar uma pressão curta no botão (☰) (Menu) e vai aparecer no ecrã um menu contextual para o ajuste do brilho, contraste e cor da imagem.

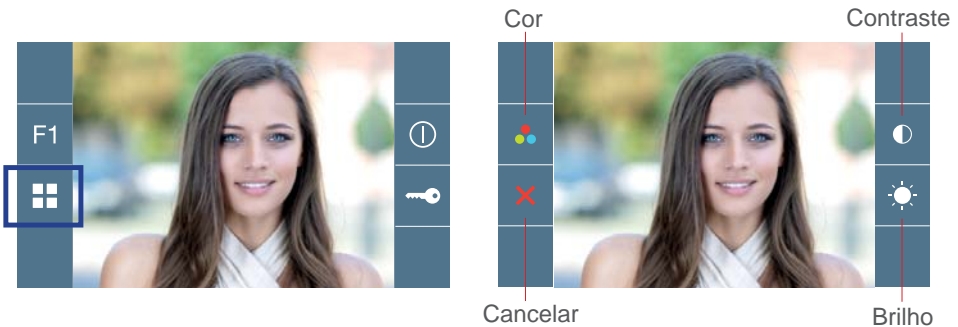

1. Selecionar os ajustes de contraste, brilho e cor, com os botões correspondentes.

A partir destes ecrãs também se pode ativar o áudio (*iniciar a comunicação*).

Nota: O tempo para realizar os Ajustes de Vídeo é de 30 segundos, transcorrido este tempo o monitor voltará ao modo repouso. A partir destes ecrãs também se pode ativar o áudio (iniciar a comunicação).

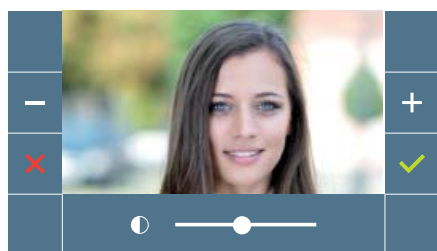

Contraste

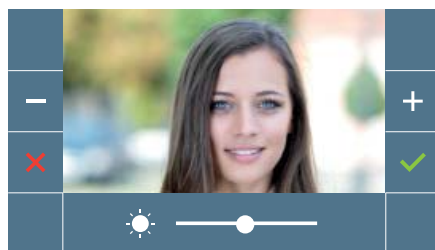

Brilho

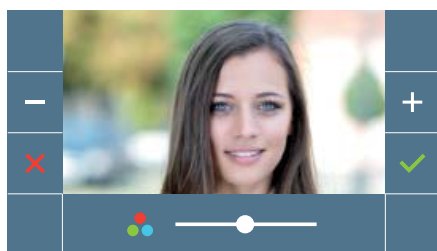

Cor

5.2 AJUSTES: AJUSTE ÁUDIO

Durante o tempo que o canal de áudio está aberto podemos regular o volume de áudio. Para realizar o ajuste de áudio, premir o botão  (*menu*) e vai aparecer no ecrã um menu contextual para o ajuste em questão.

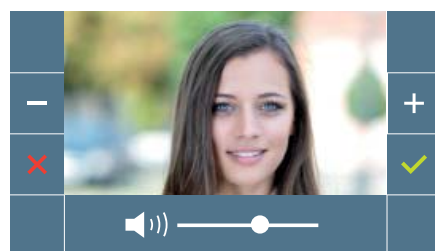
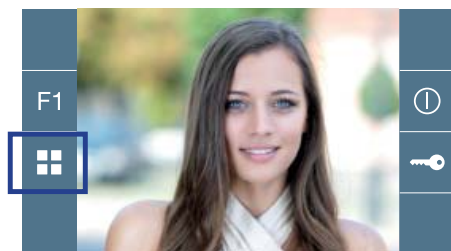

 Manual Usuário: FUNCIONAMENTO

FUNCIONAMENTO

1. FUNCIONAMENTO: **ATENDER UMA CHAMADA. Recepção de chamadas.**

Ao pressionar o botão de chamada na **Botoneira de Rua**, produz-se um tom de chamada na mesma e no monitor além de acender o ecrã. Dispomos de 30 segundos para responder antes de que regresse à situação de repouso. Durante este tempo, o led vermelho vai apagar para saber que a chamada está pendente de resposta.

Pode-se retirar o braço e manter uma conversa com a botoneira de rua. A comunicação vai finalizar automaticamente após 90 segundos ou em qualquer momento ao colocar novamente o braço do telefone.

Notas:

- Se existirem vários monitores/telefones na mesma vivenda só o primeiro a retirar o telefone conseguirá ter áudio, voltando os restantes monitores/telefones ao modo repouso. Se algum deles tentar retirar o telefone vai obter um tom de linha ocupada.
- Se não se estabelecer comunicação (retirando o braço) com a botoneira de rua, o monitor apaga-se automaticamente passados 30 seg.

Ao receber uma chamada a partir da botoneira, é possível abrir a porta em qualquer momento, premindo o botão .

1.1 Vídeochamada.

Se a vivenda receber uma chamada de uma botoneira de vídeo, o monitor exibirá o vídeo capturado pela câmara na botoneira de rua.

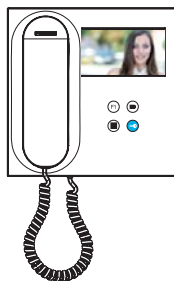

1.2 Vídeochamada.

Se a vivenda receber uma chamada de uma botoneira de áudio, o monitor exibirá o seguinte ecrã:

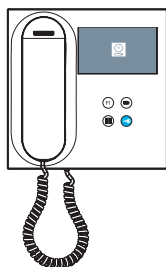

1.3 Chamada para o Porteiro.

Se um monitor estiver configurado no modo MISTO ou no modo DIA, ao premir o botão do trinco da porta enquanto inativo o mesmo iniciará uma chamada para a portaria que o configurou neste modo. O ecrã do monitor exibirá a seguinte imagem e um tom de toque será emitido (RINGING).

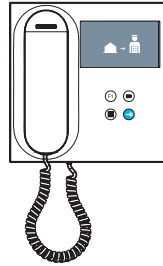

Se receber uma chamada do porteiro no monitor da vivenda, será apresentada a seguinte imagem:

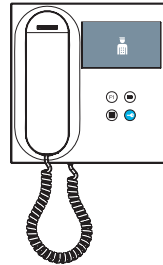

2. FUNCIONAMENTO: ATIVAÇÃO MANUAL DO MONITOR (ALIMENTAÇÃO AUTOMÁTICA)

Com o monitor no modo de espera, pressione o botão (câmara)  para ligar manualmente o monitor.

As temporizações de pré-visualização sem áudio (30sec) ou conversa (90sec) no total, mesmo que mude de câmara.

Ligação automática em repouso:

1. Se a chamada anterior da botoneira tiver terminado há menos de 15 segundos, realiza-se uma nova chamada à botoneira em questão: **R**.



2. Se o ponto anterior não ocorrer, a inicialização automática começa com as diferentes botoneiras visíveis no monitor.

Pressionando sequencialmente a Botoneira 0, Botoneira 1, Botoneira Geral, (de acordo com a disponibilidade da botoneira).

- 1 Botoneira 0 ou Câmara 0 do Bloco do monitor.
- 2 Botoneira 1 ou Câmara 1 do Bloco do monitor.
- 3 Botoneira 0 ou Câmara 0 da Entrada Geral.

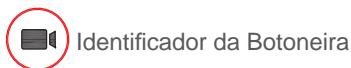

Uma vez estabelecida a comunicação com uma botoneira, esta pode ser alterada premindo o botão (câmara) .

Ligação automática no estado de chamada recebida:

1. Se a chamada corresponder a uma botoneira da sequência descrita no ponto anterior, a auto-ignição continua até à placa seguinte da sequência.
2. Se a chamada NÃO for feita a partir de uma botoneira, o arranque automático inicia com a botoneira do bloco 0 (dependendo da disponibilidade da placa) e segue a sequência:



- 1 Botoneira 0 ou Câmara 0 do Bloco do monitor.



- 2 Botoneira 1 ou Câmara 1 do Bloco do monitor.



- 3 Botoneira 0 ou Câmara 0 da Entrada Geral.

Notas:

- O arranque automático só pode ser efetuado com as botoneiras indicadas. Se não conseguir executar o arranque automático, consulte o seu instalador. Ao completar as tentativas de conexão com cada uma das três botoneiras possíveis, se isso não for possível, o monitor emitirá um tom de erro e voltará ao estado de inatividade.
- No final de qualquer comunicação com uma botoneira, durante 15 segundos, se o botão de alimentação automática for pressionado novamente, voltará a conectar-se com essa botoneira.
- Na ligação automática sem estabelecimento de áudio, se se abrir a porta após 5 segundos a chamada terminará.
- Se um segundo monitor arrancar automaticamente, é possível distinguir vários casos:
 - o O primeiro monitor está em modo de ligação automática e não estabeleceu uma conversa com o áudio: Neste caso, a ativação automática do segundo monitor não é permitida.
 - o O primeiro monitor efetuou um arranque automático e estabeleceu uma conversa de áudio: a configuração de arranque automático pode ser iniciada.
 - o Em qualquer caso, no final da conversa ou no arranque automático apenas com vídeo do primeiro monitor, o segundo monitor pode iniciar o arranque automático.

3. FUNCIONAMENTO: VISUALIZAÇÃO DE IMAGENS

Função para ver todas as capturas de imagens realizadas. A função de captura de imagens deve estar previamente ativada. [Ver capítulo 4.5 Menu USUÁRIO - 4.5.3 Ativação/Desativação de imagens.](#)

Ao realizar uma chamada a partir da botoneira de rua, (a função de captura de imagens deve estar previamente ativada), transcorridos 3 segundos, realiza-se automaticamente uma fotografia, que será armazenada na memória.

Nota: O número máximo de imagens que se podem armazenar é 150, se se armazenar uma imagem nova com a memória cheia, a imagem mais antiga será apagada.

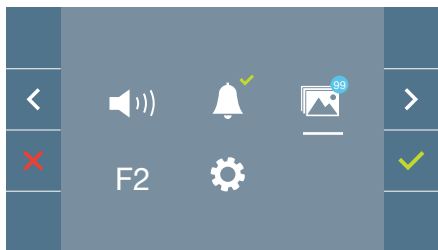

Selecionar o ícone  para visualizar as diferentes fotografias realizadas.

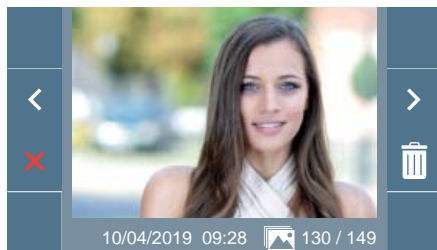

Mostra a imagem mais recente com a data, hora e número de fotografia.

Aparece un menú contextual:



: Para seleccionar/visualizar fotografias salvasdas.





: Para apagar imagens.

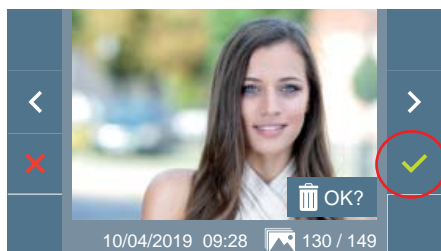

: Para cancelar e ir ao ecrã anterior.



Se premir a opção de apagar  acederá ao ecrã de confirmação de apagar imagens, premindo o ícone correspondente a confirmar  a fotografia seleccionada será eliminada. O usuário pode navegar através das fotografias salvasdas, inclusive quando a janela de confirmação estiver ativa.

Nota: Se se mantiver o ícone correspondente a confirmar pressionado  durante 5 segundos, todas as imagens podem ser apagadas após confirmação.

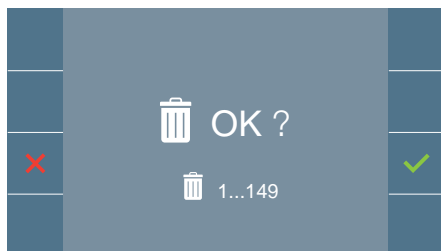

Se existirem capturas de imagens que não foram visualizadas pelo usuário vão aparecer notificações no ícone do menu de usuário e no ecrã de vídeo.

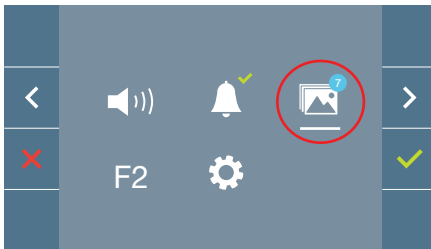

O ícone de visualização de imagens muda mostrando um círculo azul com o número de imagens por visualizar (máximo 99). No círculo, será descontado o número de imagens visualizadas pelo usuário.



Quando se produzir uma chamada, informa-se que existem fotografias por visualizar, não especificando neste caso o número.

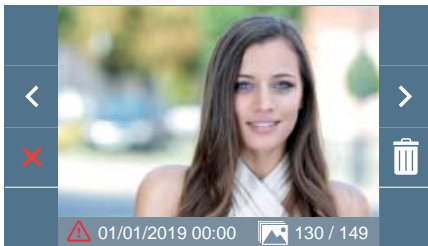

Se por algum motivo perdermos a alimentação no monitor, a configuração da data e hora passará a ser a configuração padrão (01/01/2019). Se se capturar uma imagem sem ter ajustado a data e hora, na visualização da imagem vai aparecer este ícone , indicando que os ajustes de data e hora que aparecem junto à imagem não são corretos.



El O equipamento que adquiriu está identificado de acordo com a Diretiva 2012/19/UE relativa aos resíduos de equipamentos elétricos e eletrónicos. Mais informação:





Avd. Tres Cruces, 133
46017 Valencia
Spain

Para más información, visitar www.fermax.com

Contacto: tec@fermax.com / www.fermax.com/contact

For extended information, visit www.fermax.com

Contact: tec@fermax.com / www.fermax.com/contact

Pour de plus amples renseignements, rendez-vous sur www.fermax.com

Contact : tec@fermax.com / www.fermax.com/contact

Für weitere Information siehe www.fermax.com

Kontakt: tec@fermax.com / www.fermax.com/contact

Para informação detalhada, visite www.fermax.com

Contacto: tec@fermax.com / www.fermax.com/contact