

KLIC-DI v2

KNX - Daikin Gateway for Commercial and Industrial Range Daikin A/C Units

ZCLDIV2

Application program version: [1.2]

User manual edition: [1.2]_b

www.zennio.com

CONTENTS

Contents	2
Document Updates	3
1 Introduction	4
1.1 KLIC-DI v2	4
1.2 Installation.....	5
1.3 Start-Up and Power Loss.....	6
2 Configuration.....	7
2.1 General.....	7
2.2 A/C Gateway	9
2.2.1 Configuration	9
2.2.2 Initial Configuration	24
2.2.3 Scenes	26
2.2.4 Error Handling.....	27
2.3 Inputs	29
2.3.1 Binary Input.....	29
2.3.2 Temperature Probe.....	29
2.3.3 Motion Detector	29
2.4 Logic Functions.....	30
ANNEX I. Communication Objects.....	31

DOCUMENT UPDATES

Version	Changes	Page(s)
[1.2]_b	Changes in the document: <ul style="list-style-type: none"> Clarification on KLIC-DI v2 configuration in case of controlling units with R32 refrigerant. 	12
[1.2]_a	Changes in the application program: <ul style="list-style-type: none"> Object to receive the temperature of the master control probe. Optimisation of the Heartbeat, Logic Functions and Temperature Probe modules. 	-
[1.1]_a	Changes in the application program: <ul style="list-style-type: none"> Functionality <i>Operation mode management</i>: <ul style="list-style-type: none"> Parameter is removed. New status object to know the type of machine being controlled. Optimisation of the Binary Inputs and Motion Detector modules. 	-

1 INTRODUCTION

1.1 KLIC-DI V2

KLIC-DI v2 from Zennio is a gateway that enables **full-duplex** communication between the KNX home automation system and **commercial and industrial range Daikin air-conditioning systems** through the 2-wire connection provided by the latter.

Because of this **bidirectional** communication, the air conditioning system can be controlled from the home automation system in the same manner as it is through its own controls. Moreover, the actual status of the unit can be monitored and periodically sent to the KNX bus to inform other devices.

The most outstanding features of KLIC-DI v2 are:

- **Bidirectional control** of Daikin A/C units of **SKY** commercial range or **VRV** industrial range with variable refrigerant volume.
- Control of the **main functions** of the commercial and industrial range Daikin A/C unit: On/Off, temperature, mode of operation, fan speed, swing of the flaps, etc.
- **Error management** to handle specific error codes from the A/C unit itself as well as any communication issues that may arise.
- **2 analogue-digital inputs**, for the connection of temperature probes, motion detectors or binary pushbuttons or switches.
- **10** customisable, multi-operation **logic functions**.
- Up to **five scenes**.
- **Heartbeat** or periodic “still-alive” notification.

1.2 INSTALLATION

1. Prog./Test LED
2. Prog./Test button
3. 2-wire communication connection with A/C unit (P1/P2 port).
4. Inputs Connector.
5. KNX Connector.

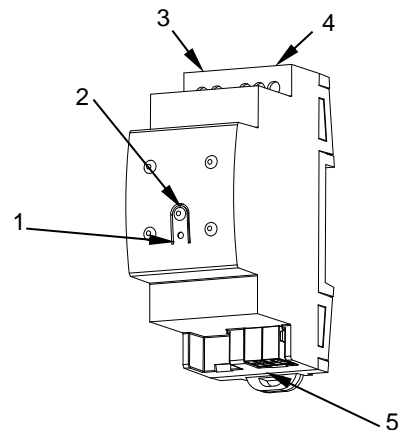

Figure 1. Element scheme

KLIC-DI v2 connects to the KNX bus via the corresponding built-in terminal (5). Once the device is provided with power from the KNX bus, both the physical address and the KLIC-DI v2 application program can be downloaded.

This device does not need any external power as it is entirely powered through the KNX bus.

The remaining elements are described next.

- **Prog./Test button (2):** a short press on this button will set the device into the programming mode, making the associated LED (1) light in red.

Note: if this button is held while plugging the device into the KNX bus, the device will enter into safe mode. The LED will blink in red every 0.5 seconds

- **Analogue-Digital Inputs (4):** input ports for the stripped cables of external elements such as switches, motion detectors, temperature probes, etc.
- **P1/P2 Communication (3):** 2-wire communication cable that will connect KLIC-DI v2 to the A/C unit. The other end of the cable, therefore, is intended to be connected to the P1/P2 connector in the PCB board of the internal unit.

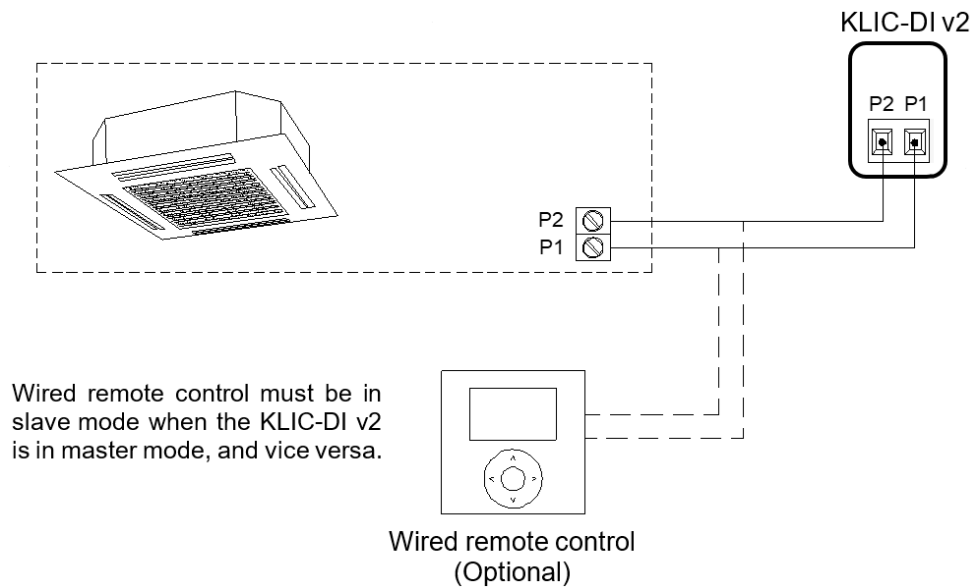

Figure 2. Connecting KLIC-DI v2 to the P1/P2 bus.

Important: *if intending to control the A/C unit both through its incorporated wired remote control and through KLIC-DI v2, it must be taken into account the master-slave configuration assigned to both of them.*

For detailed information about the technical features of KLIC-DI v2, as well as on security and installation procedures, please refer to the device **Datasheet**, bundled in the device packaging and available at www.zennio.com.

1.3 START-UP AND POWER LOSS

Depending on the configuration, some specific actions will be performed during the device start-up. The integrator may set up an initial status to be sent to the A/C unit after the bus power restored, as well as the sending of certain objects to the KNX bus, as described in later sections.

On the other hand, when a bus power failure takes place, the device will interrupt any pending actions, and will save its state so it can be recovered once the power supply is restored.

2 CONFIGURATION

2.1 GENERAL

The general configuration of the device consists in enabling the specific functionalities that will be required during normal operation:

- **Heartbeat** or periodic “still-alive” notification.
- **Inputs**.
- **Logic functions**.
- **A/C gateway**.

The latter entails all functions specific to KLIC-DI v2, i.e., all the functions related to interfacing with the A/C unit and to the management of the climate control system.

ETS PARAMETERISATION

After importing the corresponding database in ETS and adding the device into the topology of the desired project, the configuration process begins by entering the Parameters tab of the device.

The General screen is shown in the first place, containing the following parameters:

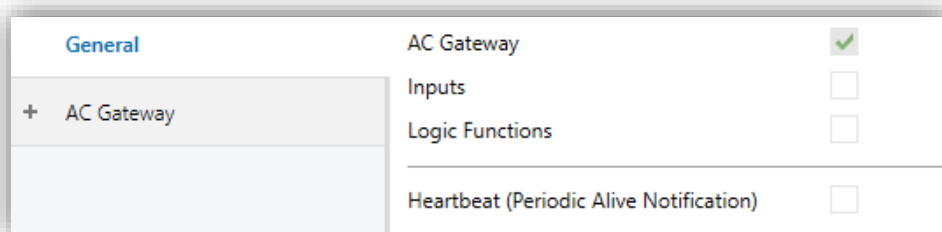

Figure 3. General

- **A/C Gateway** [[enabled](#)]¹: enables the “A/C Gateway” tab in the tree on the left. For more information, see section 2.2.

¹ The default values of each parameter will be highlighted in blue in this document, as follows: [[default/rest of options](#)].

- **Inputs** [[disabled/enabled](#)]: enables or disables the “Inputs” tab in the tree on the left, depending on whether the device will or will not be connected any external accessories. For more information, see section 2.3.
- **Logic Functions** [[disabled/enabled](#)]: enables or disables the “Logic Functions” tab in the tree on the left. For more information, see section 2.4.
- **Heartbeat (Periodic Alive Notification)**: this parameter lets the integrator incorporate a 1-Bit object to the project (“**[Heartbeat] Object to Send ‘1’**”) that will be sent periodically with value “1” to notify that the device is still working (*still alive*).

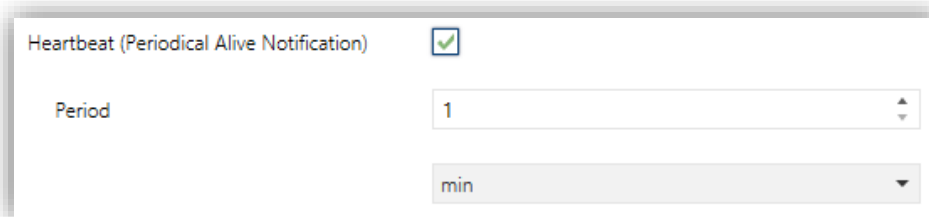

Figure 4. Heartbeat

Note: *the first sending after download or bus failure takes place with a delay of up to 255 seconds, to prevent bus overload. The following sendings match the period set.*

- **Device Recovery Objects (Send 0 and 1)** [[disabled/enabled](#)]: this parameter lets the integrator activate two new communication objects (“**[Heartbeat] Device Recovery**”), which will be sent to the KNX bus with values “0” and “1” respectively whenever the device begins operation (for example, after a bus power failure). It is possible to parameterise a certain **delay** [[0..255](#)] to this sending.

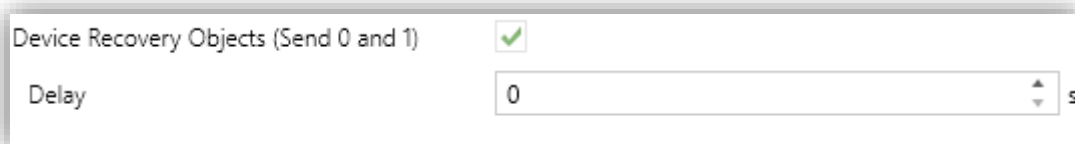

Figure 5. Device Recovery Objects.

Note: *After download or bus failure, the sending takes place with a delay of up to 6,35 seconds plus the parameterised delay, to prevent bus overload.*

Regardless of the above parameters, the following objects are available by default:

- “[AC] On/Off” and “[AC] On/Off (Status)”: allow switching on (value “1”) and off (value “0”) the A/C unit or reading the current status, respectively.
- “[AC] Temperature Setpoint” and “[AC] Temperature Setpoint (Status)”: allow setting the desired temperature setpoint or reading the current value, respectively. See section 2.2.1 for further options.
- “[AC] Mode” and “[AC] Mode (Status)”: allow setting the desired operation mode (either Automatic, Heating, Cooling, Fan or Dry) or reading the current mode, respectively. See section 2.2.1 for further options.
- “[AC] Fan: Percentage Control” and “[AC] Fan: Percentage Control (Status)”: allow establishing desired fan speed or reading the current fan speed, respectively. See section 2.2.1.
- Several **error objects**. See section 2.2.4.
- “[AC] Operation Mode Management (Status)”: This object is only available on VRV Units. It indicates whether the KLIC-DI v2 will control a *master or slave of mode* unit in case several machines are connected to the same outside machine. See section 2.2.1.

2.2 A/C GATEWAY

2.2.1 CONFIGURATION

KLIC-DI v2 allows controlling and monitoring an air-conditioning unit in the same way it would be through the wired remote control it is provided with.

Through the KNX bus, KLIC-DI v2 can be sent orders to control the following basic functions of the air conditioning unit:

- **On/Off** switch of the air-conditioning unit.
- **Operation mode**: automatic, heating, cooling, fan and dry.
- **Temperature setpoint**, which can be modified within a 16-32°C range.

- **Fan speed:** 2 or 3 levels, depending on the model of the A/C unit.
- **Control of flaps (or vanes) positioning:** direct positioning or swing movement of flaps, depending on the A/C unit.

Moreover, KLIC-DI v2 allows configuring several advanced functions:

- **Remote control configuration:** which allows establishing the type of master-slave control desired to KLIC-DI v2.
- **Indoor unit model:** allows to select the indoor unit model between VRV and Sky Air.
- **Reference temperature:** which allows supervising reference temperature that it is taken into account by A/C unit for control temperature. This temperature can be the internal temperature of A/C unit or an external reference temperature, provided by a temperature probe.
- **Setpoint limits:** to restrict the range for the temperature setpoint.
- **Automatic off,** which allows an automatic and temporary switch-off of the unit (after a pre-established delay, if desired) when the communication object associated to this function is triggered due to a certain event.
- **Initial configuration,** which allows establishing the desired initial parameters for the state of the A/C unit after programming or restarting the device.
- **Scenes,** which allows defining predefined climate control environments, to be sent to the machine on the reception of scene orders from the KNX bus.
- **Operation time** provides in hours and/or seconds the A/C unit operating time.

These functionalities imply changes in the state of the A/C unit, which therefore notifies KLIC-DI v2 periodically about the current state. When KLIC-DI v2 is notified about a change, it updates the **status objects** and sends them to the KNX bus. In addition, KLIC-DI v2 provides an **error management** function (see section 2.2.4), which allows sending messages to the KNX bus in case the A/C unit reports any errors.

ETS PARAMETRIZATION

The Configuration window under A/C Gateway provides the following parameters:

General	REMOTE CONTROL
AC Gateway	Remote Control Type <input checked="" type="radio"/> Master <input type="radio"/> Slave
Configuration	INDOOR UNIT
	Indoor Unit Model <input checked="" type="radio"/> VRV <input type="radio"/> Sky Air
	OPERATION MODES
	Simplified Mode (Only Cooling/Heating) <input type="checkbox"/>
	VENTILATION
	Fan Speeds (*) <input checked="" type="radio"/> 2 <input type="radio"/> 3
	Flaps (*) <input checked="" type="checkbox"/>
	Swing Objects <input type="checkbox"/>
	(*) Configure according to the available functions in the indoor unit.
	REFERENCE TEMPERATURE
	External Reference Temperature Object <input type="checkbox"/>
	Reference Temperature State Object <input type="checkbox"/>
	TEMPERATURE SETPOINT
	Setpoint Limits <input type="checkbox"/>
	AUTOMATIC OFF
	Automatic Off <input type="checkbox"/>
	INITIAL CONFIGURATION
	Initial Configuration <input checked="" type="radio"/> Default <input type="radio"/> Custom
	SCENES
	Scenes <input type="checkbox"/>
	OPERATION TIME
	Seconds <input type="checkbox"/>
	Hours <input type="checkbox"/>

Figure 6. A/C Gateway. Configuration.

REMOTE CONTROL

REMOTE CONTROL
Remote Control Type <input checked="" type="radio"/> Master <input type="radio"/> Slave

Figure 7. A/C Gateway. Configuration. Remote control.

- **Remote control type** [*Master / Slave*]: configures the control type of KLIC-DI v2.

The **master** control type will correspond to the device which directly communicates with the machine. It will also be in charge of retransmitting the instructions to the **slave** control, if any. This configuration will still permit controlling the machine from the slave control.

This feature allows connecting to the same installation both the KLIC-DI v2 interface and the wired remote control of the A/C unit.

Important:

- *In case of having KLIC-DI v2 and the wired remote control operating together, please, make sure that the control type of both devices is not the same (necessarily one of them must be master and the other slave).*
- *In the case of controlling **units with R32 refrigerant**, it is mandatory to have a **Madoka as master of the installation** and, therefore, the KLIC-DI v2 must be configured as a slave.*

Notes:

- *Switching the wired control between the slave and master modes requires interrupting its power supply in order to make the wired control re-initialise under the new mode.*
- *If the power supply of the wired control fails, it may be necessary to disconnect and reconnect the bus voltage of the device after the power supply has been restored in order for the configuration between the wired control unit and the KLIC-DI v2 to be successful (especially if the KLIC-DI v2 has been configured as master and the wired control as slave).*

INDOOR UNIT



Figure 8. A/C Gateway. Configuration. Indoor unit.

- **Indoor unit model** [[VRV / Sky Air](#)]: KLIC-DI v2 must be configured according to the indoor unit model which will be controlled.

In case of selecting “[VRV](#)” as the indoor model unit, the 1-Byte object “[**AC**] **Operation Mode Management (Status)**” is enabled. This object enables to know if an indoor unit is configured as master or as a slave of mode.

The concept of the **Master Unit** is derived from the possibility of having several indoor A/C units within the same facility, all of them connected to a single outdoor unit. Unless there is a BS box installed, there may be only one main mode active at any time, and therefore a single internal unit may work as a master unit, being the only one able of switching the active mode. The remaining indoor units (and their respective master or slave controls) will act as **slave units**, thus will only have certain modes available, depending on the currently active main mode.

Table 1 shows the different modes that can be selected from the device depending on whether it is controlling a master unit or as a slave unit. Note that in case of acting as a slave unit, the available modes will depend on the mode currently under selection by the master of mode.

Modes available for selection									
Master Unit	Cool			Heat		Fan	Dry		
Slave Unit	Cool	Fan	Dry	Heat	Fan	Fan	Cool	Fan	Dry

Table 1. Configurable modes from a master of mode and from a slave of mode.

If a KLIC-DI v2, which controls a slave mode unit, changes to a different mode from allowed modes (according to master unit main mode), the mode of master unit will be established.

For example, if master unit is operating in Heat mode, the allowed modes in a slave unit will be Heat and Fan, while disallowed modes will be Cool and Dry. Thus, if KLIC-DI v2, which controls a slave mode unit, changes to Dry or Cool mode (disallowed modes), through KNX bus Heat mode will be received. Conversely, if the slave unit changes to Fan or Heat mode, then there will be established in this unit and these statuses will be received through KNX bus.

Please, note that simplified mode functionality will not be available with a configuration of a slave mode unit (“**[AC] Simplified Mode**”), due to it would not be useful.

Notes:

- *If an installation with multiply indoor A/C units connected to a single outdoor unit has a BS box, all units can change its mode as master unit. Therefore, in case of using a BS box, all KLIC-DI v2 which control indoor unit will show its “operation mode management” as master units.*

OPERATION MODES

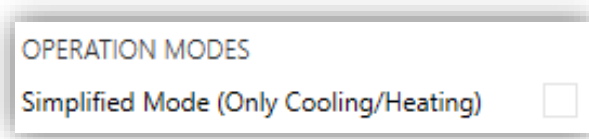

Figure 9. A/C Gateway. Configuration. Operation modes.

KLIC-DI v2 allows controlling the A/C unit operating mode through the following objects, available by default:

- **“[AC] Mode”**: 1-Byte object which allows selecting the A/C unit operation mode. There will be only taken in account values that are appropriated with some of available modes in Daikin units, which are represented in Table 2.
- **“[AA] Mode (status)”**: 1-Byte object which allows knowing the A/C unit operating mode status.

Object Value	A/C unit mode
0	Auto
1	Heating
3	Cooling
9	Fan only
14	Dry

Table 2. A/C unit operating modes.

Additionally, a simplified mode can be configured to select Cooling and Heating mode.

- **Simplified Mode (Only Cooling/Heating)** [[disabled/enabled](#)]: in addition to the “**Mode**” and “**Mode (Status)**” 1-Byte objects, available by default, it is possible to commute and to verify the current operation mode through the following 1-Bit objects, which get enabled after activating this parameter:
 - “**Simplified Mode**”, which allows switching to the Cooling mode by sending it a “0” and to the Heating mode by sending it a “1”.
 - “**Simplified Mode (Status)**”, which will send a value of “0” when the mode switches to Cooling or to Dry, or a value of “1” when it switches to Heating. The Fan mode is not reflected in the value of this object. In Auto mode the value will be actualized depending of the current mode operating: Auto-Cooling (“0”) or Auto-Heating (“1”).

Notes: *In an installation with both KLIC-DI v2 and wired control remote, and mode changes (Auto-Cool to Auto-Heat or vice versa) are performed from both controls during automatic mode, that the setpoint/ventilation/flame states are updated to those of the last time the mode was entered is possible.*

VENTILATION

VENTILATION

Fan Speeds (*) 2 3

Flaps (*)

Swing Objects

Swing Objects Polarity 0 = Swing On; 1 = Swing Off
 0 = Swing Off; 1 = Swing On

(*) Configure according to the available functions in the indoor unit.

Figure 10. A/C Gateway. Configuration. Ventilation.

- **Fan Speeds** [[2/3](#)]: specified the number of the fan levels distinguished by A/C unit.

KLIC-DI v2 allows the sending of fan speed change orders to the A/C unit to switch the ventilation speed along the available levels. To that end, KLIC-DI v2 provides a **percentage** control through the objects “[AC] Fan: percentage control” y “[AC] Fan: percentage control (Status)”, available by default.

Important: fan speed must be configured according to the available functions in the A/C unit.

Table 3 and Table 4 reflect the percentage values that refer to several ventilation levels:

Control Value	Status Value	Level sent to the A/C unit
0-50%	50%	1 (minimum)
51-100%	100%	2 (maximum)

Table 3. Fan Speed for 2 levels of ventilation.

Control Value	Status Value	Level sent to the A/C unit
0-33%	33%	1 (minimum)
34-66%	66%	2
67-100%	100%	3 (maximum)

Table 4. Fan Speed for 3 levels of ventilation.

Note: In dry mode, A/C unit sets fan speed in automatic mode. Due to this fact the fan speed control orders will be ignored during this mode, and will be taken into account when Dry mode expires.

- **Flaps** [*disabled/enabled*]. Flaps function allows sending the A/C unit orders to switch the position of the flaps (or vanes), in case of being available in the unit.

Important: this parameter must be configured according to the available functions in the A/C unit, in order not to cause an abnormal control or behaviour of the air machine. Note that, if this parameter is not configured properly, the communication with a slave remote wired control will not be possible, in case of having it in the installation.

When flaps are enabled, “[AC] Flaps: Percentage Control” and “[AC] Flaps: Percentage Control (Status)” 1-byte objects are available, which allow sending the A/C unit orders to switch the position of the flaps or activating the swing function and supervising flaps status. Furthermore, it will appear a new parameter called *Movement objects*.

Control values	Status value	Position sent to the Unit
0%	0%	Swing
1-20%	20%	Position 1
21-40%	40%	Position 2
41-60%	60%	Position 3
61-80%	80%	Position 4
81-100%	100%	Position 5

Table 5. Flaps Control

- **Swing objects** [*disabled/enabled*]: enables 1-Bit objects “[AC] Flaps: Swing” and “[AC] Flaps: Swing (Status)” to activate or not swing movement and, also, consulting its status.

The parameter **Swing object polarity** [*0 = Swing On; 1 = Swing Off / 0 = Swing Off; 1 = Swing On*] is available to set the polarity of the enabled objects.

Note: on certain A/C unit models, positions 3-5 may not be available under the Cool mode, as a measure to prevent that a cold air flow is outputted directly to particular points of the room where people are supposed to stand. Analogously, positions 1 and 2 may not be permitted by the A/C unit under the Heat mode, to prevent hot air accumulation on the top of the room.

REFERENCE TEMPERATURE

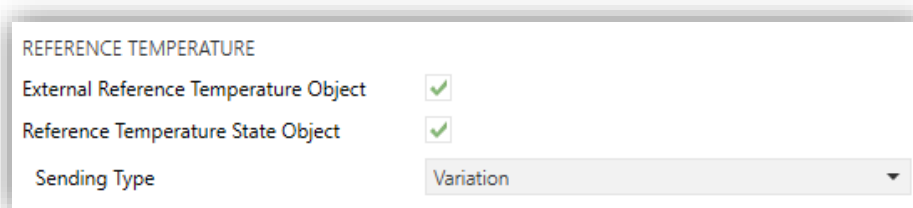

REFERENCE TEMPERATURE

External Reference Temperature Object

Reference Temperature State Object

Sending Type Variation

Figure 11. A/C Gateway. Configuration. Reference temperature (master control).

- **External reference temperature object** [*disabled/enabled*]: enables a 2-Byte object “[AC] External Reference Temperature” which will receive the temperature values provided by an external temperature probe and these values will be employed by the A/C unit to control the temperature (instead of employing its internal values). If during 3 minutes, no temperature values are received, values of the internal probe will be recuperated again to execute

temperature control, in the same way as it will be controlled if KLIC-FJ was configured disabling this option. If a new external temperature value is received, the control will be again executed by using this external value. The values allow to be received in this object are include in [0-63.5] °C (if different values are received, they will be ignored).

Note: *external reference temperature object only will be available if KLIC-DI v2 is configured as master control.*

Depending on how KLIC-DI v2 is configured, the status of the reference temperature will be shown. If KLIC-DI v2 is configured as master control, the following object can be selected:

- **Reference temperature state object** [*disabled/enabled*]: enables a 2-Byte object “[AC] Reference Temperature (Status)” which informs of the temperature that the A/C Unit use as reference to do the temperature control (internal or external).

On the other hand, if KLIC-DI v2 is configured as slave control, the following objects can be selected:

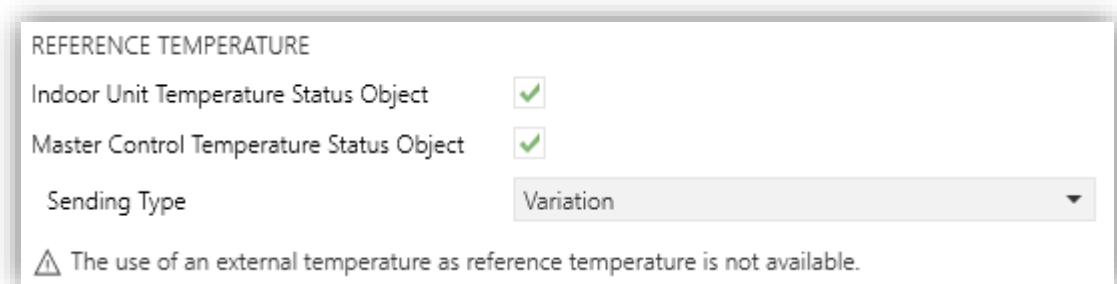

REFERENCE TEMPERATURE

Indoor Unit Temperature Status Object

Master Control Temperature Status Object

Sending Type Variation

⚠ The use of an external temperature as reference temperature is not available.

Figure 12. A/C Gateway. Configuration. Reference temperature (slave control).

- **Indoor Unit Temperature Status Object** [*disabled/enabled*]: enables a 2-Byte object “[AC] Indoor Unit Temperature (Status)” which provides the value of the temperature measured by the A/C Unit.
- **Master Control Temperature Status Object** [*disabled/enabled*]: enables a 2-Byte object “[AC] Master Control Temperature (Status)” which provides the value of the temperature measured by the master control probe used as reference.

Note: If the master control does not send any reference temperature, the temperature status object of the master control will send the temperature value of the indoor unit.

- **Sending type:** defines the mode in which the reference temperature will be sent:
 - [[Variation](#)]: reference temperature will be sent when there is almost a variation of 0.1°C, and additionally, 30 seconds have passed from the previous sending to avoid KNX bus saturation.
 - [[Periodic](#)]: reference temperature will be sent periodically according to the configured sending **period** [[30...3600](#)][s] / [[1...15...1440](#)][min] / [[1...24](#)][h].
 - [[Periodic + Variation](#)]: consists of the combination of the two previous options, the sending will be made by variation and periodically.

Note: *Daikin indoor units have three different ways to be programmed in regards with its reference temperature. This configuration must be done by a Daikin qualified technician or installer using wired remote control.*

- 1) *Use of external and internal reference temperature: the indoor unit uses its own return temperature when there is a big difference between the ambient temperature and the setpoint temperature. The ambient temperature will be used from the Master device (remote controller, or KLIC-DI device) when this difference is small.*
- 2) *Use of internal reference temperature: the indoor unit always uses its own return temperature.*
- 3) *Use of external reference temperature: the indoor unit only uses the ambient temperature from the Master device (Daikin wired remote control or KLIC-DI v2 device).*

This functionality must be configured in the unit according with the KLIC-DI v2 parametrization in order to do an effective temperature control. For example, a wrong configuration would be one in where indoor unit employs one of the options that uses external reference temperature and configuring a master KLIC-DI v2 without external reference temperature to control it.

TEMPERATURE SETPOINT

TEMPERATURE SETPOINT	
Setpoint Limits	<input checked="" type="checkbox"/>
Minimum (Cooling/Auto Mode)	18 °C
Maximum (Heating/Auto Mode)	30 °C

Figure 13. A/C Gateway. Configuration. Temperature setpoint.

The following objects to control and supervise setpoint temperature will be available by default:

- “[AC] Temperature Setpoint”: 2-Byte object to select decimal temperature values that belong to the range [16°-32°].
- “[AC] Temperature Setpoint (Status)”: 2-Byte object that provides the Temperature setpoint status.

Note: A X.Y value will be rounded to X.0 if [Y < 5] or to X.5 if [Y ≥ 5].

Status object will be updated to the last setpoint temperature value received by the A/C unit after a complete communication cycle and will be sent to KNX bus every time that its value changes.

Setpoint limits can be configured by parameter:

- **Setpoint Limits** [*disabled/enabled*]: allows restricting the range of the temperature setpoint (from below in the Cooling and Auto modes and from above in the Heating and Auto modes), provided that the limits are still within the predefined limits of the A/C unit. When KLIC-DI v2 receives an order to send the A/C unit a setpoint which is greater (or lower) than the configured limits, it will actually send the limit value.
 - **Minimum (Cooling / Auto Mode)** [*16...18...32*] °C: sets the upper limit.
 - **Maximum (Heating / Auto Mode)** [*16...30...32*] °C: sets the lower limit.

Once these limits are enabled, several objects to modify them at run time will be available. The values of this objects will be restricted to an interval which is defined by the absolute limits established by the A/C unit (10°C to 32°C).

- “[AC] Temperature Setpoint: Lower Limit”: 2-Byte object that allows changing the lower limit at run time.
- “[AC] Temperature Setpoint: Lower Limit (Status)”: 2-Byte object with the lower limit current value.
- “[AC] Temperature Setpoint: Upper Limit”: 2-Byte object that allows changing the upper limit at run time.
- “[AC] Temperature Setpoint: Upper Limit (Status)”: 2-Byte object with the upper limit current value.

Notes:

- *If [Minimum] ≥ [Maximum], limits will not be taken in account in Auto mode due to the incongruity. In this case, default values will be used.*
- *These parameters only can be set as integer values in ETS. However, at run time the associated objects allow decimal values.*
- *The A/C unit set a fixed temperature setpoint in Fan and Dry mode, this is the reason why KLIC-DI v2 will not send the setpoint value to A/C unit, however the value will be saved in order to be sent when these modes expires.*
- *The setpoint limits set by the A/C unit on each operating mode are indicated in Table 6, however, these limits can be more restrictive changing the configuration with the wired remote control:*

Mode	Temperature Setpoint
Auto	[16°-32°]
Cooling	[16°-32°]
Heating	[16°-32°]
Fan	Not available
Dry	Not available

Table 6. Interior setpoint limits of A/C unit

AUTOMATIC OFF

AUTOMATIC OFF

Automatic Off

Automatic Off Object Polarity 0 = Activate; 1 = Deactivate
 0 = Deactivate; 1 = Activate

Automatic Off Delay s

Figure 14. A/C Gateway. Configuration. Automatic off.

- **Automatic Off** [*disabled/enabled*]: enables the “[AC] Automatic Off” binary object, which lets performing a temporary switch-off of the A/C unit by sending it a value of “1” and a later switch-on by sending it a value of “0”. This object will be typically linked to a window sensor or a similar event trigger. Automatic off will be also active if the unit is previously in off state, so, the unit will not be able of being on until this situation finishes.

During the temporary switch-off state, KLIC-DI v2 will still monitor any control orders being received (setpoint, fan speed, etc.), so they can be applied once it leaves such state.

- **Automatic Off Object Polarity** [*0 = Activate; 1 = Deactivate / 0 = Deactivate; 1 = Activate*]: sets the polarity of the above object.
- **Automatic Off Delay** [*1...60...3600*] s: sets the time KLIC-DI v2 waits before switching the A/C machine off. Any switch-off order received during the delay will abort the time count.

Note: *switch-on orders sent to the A/C unit from a wireless control have a higher priority than the Auto Off mode.*

INITIAL CONFIGURATION

INITIAL CONFIGURATION

Initial Configuration Default Custom

Figure 15. A/C Gateway. Configuration. Initial configuration.

- **Initial Configuration:** allows setting the desired initial state that KLIC-DI v2 will send the A/C unit after programming or restarting the device:

- [[Default](#)]: the initial state will be the last one KLIC-DI v2 is aware of.
- [[Custom](#)]: see section 2.2.2

SCENES



Figure 16. A/C Gateway. Configuration. Scenes.

- **Scenes** [[disabled/enabled](#)]: allows setting up different scenes (up to 5), consisting each of them in a set of orders to be sent to the A/C unit upon the reception of scene trigger values through the KNX bus. See section 0.

OPERATING TIME

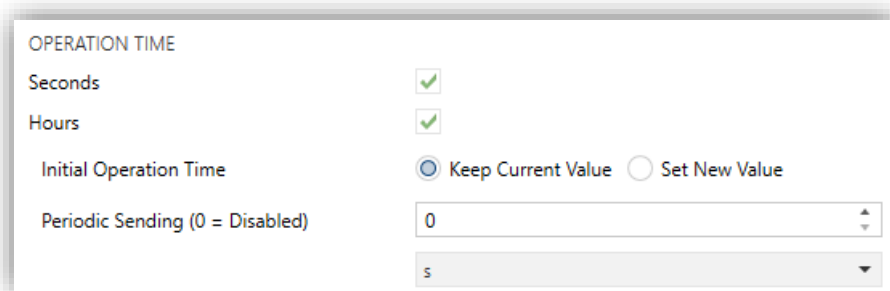

Figure 17. A/C Gateway. Configuration. Operating Time.

The operating time of the A/A machine in hours and/or seconds can be known.

The available parameters in ETS are:

- **Seconds** [[disabled/enabled](#)]: enables the 2-Byte object “[AC] Operating time (s)”. This object can be read and overwritten during executing time.
- **Hours** [[disabled/enabled](#)]: enables the 4-Byte object “[AC] Operating time (h)”. This object can be read and overwritten during executing time.
- **Initial Operation Time**, two options are available:
 - [[Keep current value](#)]: keeps the previous value.

- [Set new value]: establishes an initial operating time **value** [[0...3600][s] / [0...65535][h]].
- **Periodic Sending** [[0...3600][s] / [0...65535][min/h]]: operating time retransmission period. If set to 0 the periodic send is disabled.

When operating time object reaches its maximum value (65535h), it will be sent through KNX bus (in spite of the fact that the periodic sending has not been configured) and it will keep this value until the user reset it.

2.2.2 INITIAL CONFIGURATION

The custom initial configuration allows setting the desired status that KLIC-DI v2 will send the A/C unit after downloading or restarting the device. This status is defined in terms of on/off, mode, fan speed, flaps position and temperature setpoint.

In addition, it is possible to activate an initial sending of this status to the KNX bus.

ETS PARAMETRISATION

After selecting “Custom” for the **Initial Configuration** option under the Configuration tab (see section 2.2.1), a new tab named **Initial Configuration** is displayed with the following parameters:

On/Off	Last (Before Restart)
Mode	Last (Before Restart)
Fan Speed	Last (Before Restart)
Flaps	Last (Before Restart)
Setpoint	<input type="checkbox"/>
Value	Last (Before Restart)
Send Initial Configuration	<input type="checkbox"/>

Figure 18. A/C Gateway. Initial configuration.

- **On/Off** [Last (before restart) / On / Off].
- **Mode** [Last (before restart) / Automatic / Heating / Cooling / Fan / Dry].

- **Fan speed** [[Last \(before restart\) / 1 / 2 / 3](#)]. The number of speeds (“1 / 2” or “1 / 2 / 3”) will depend on those selected in the **Fan speeds** parameter, in the AA Gateway **Configuration** tab (see section 2.2.1, **ventilation**)
- **Flaps** [[Not Available](#)]. The following options will only be available if you enable **Flaps** in the AA Gateway **Configuration** tab (see section 2.2.1, **ventilation**): [[Last \(before restart\) / Swing / 1 / 2 / 3 / 4 / 5](#)].
- **Setpoint** [[disabled/enabled](#)]:
 - **Value.** Depending on the value of the previous parameter, it will be shown:
 - [[No change](#)]: the value of the setpoint temperature will be kept. When **Setpoint** is disabled.
 - [[16...25...32](#)] °C When **Setpoint** is enabled.

Note: *this initial setpoint value may be modified by the setpoint limits during runtime.*

- **Send initial configuration** [[disabled/enabled](#)]: If enabled, the status objects will be sent to the KNX bus after applying the parametrized **delay** [0...3600], in seconds.

Notes:

- *Even if this option is not enabled, the status objects may be sent to the KNX bus if the initial configuration differs from the current status of the A/C machine.*
- *The delay parametrized in initial configuration sending is approximate, due to it starts to be counted when the communication between KLIC-DI v2 and A/C unit is confirmed.*

2.2.3 SCENES

The Scenes function allows defining a set of statuses (in terms of On/Off, mode, fan speed, etc.) that KLIC-DI v2 will send to the A/C unit whenever it receives the corresponding scene values from the KNX bus.

ETS PARAMETRISATION

After enabling this function (see section 2.2.1), a new tab named **Scenes** will be incorporated to the tab tree. It allows setting up different scenes (up to 5), consisting each of them in a set of orders to be sent to the A/C unit upon the reception, through the KNX bus and by means of the Scenes object, of the corresponding scene value (decreased by 1, according to the KNX standard).

Scene 1	<input checked="" type="checkbox"/>
Scene Number	1
On/Off	No change
Mode	No Change
Fan Speed	No Change
Flaps	No Change
Setpoint	<input type="checkbox"/>
Value	No Change
Scene 2	<input type="checkbox"/>
Scene 3	<input type="checkbox"/>
Scene 4	<input type="checkbox"/>
Scene 5	<input type="checkbox"/>

Figure 19. A/C Gateway. Scenes.

For every enabled scene, the particular parameters that should be configured are:

- **Scene number** [[1...64](#)]: sets the scene number that, upon reception through the object “[AC] Scene” (decreased by one), will trigger the corresponding orders, as defined next:
 - **On/Off** [[No change](#) / [On](#) / [Off](#)]. If “[No change](#)” is selected, the machine will retain the last state before scene reception.
 - **Mode** [[Last \(before restart\)](#) / [Automatic](#) / [Heating](#) / [Cooling](#) / [Fan](#) / [Dry](#)].

- **Fan speed** [[No change](#) / 1 / 2 / 3]. The number of speeds (“1 / 2” or “1 / 2 / 3”) will depend on those selected in the **Fan speeds** parameter, in the AA Gateway **Configuration** tab (see section 2.2.1, **ventilation**)
- **Flaps** [[Not Available](#)]. The following options will only be available if you enable **Flaps** in the AA Gateway **Configuration** tab (see section 2.2.1, **ventilation**): [[No change](#) / [Swing](#) / 1 / 2 / 3 / 4 / 5].
- **Setpoint** [[disabled/enabled](#)]:
 - **Value.** Depending on the value of the previous parameter, it will be shown:
 - [[No change](#)]: the value of the setpoint temperature will be kept. When **Setpoint** is disabled.
 - [[16...25...32](#)] °C When **Setpoint** is enabled.

Note: *this setpoint value may be modified by the setpoint limits during runtime.*

2.2.4 ERROR HANDLING

KLIC-DI v2 is capable of managing two error types:

- **Communication or internal errors:** errors in the communication process between KLIC-DI v2 and the A/C unit:

- **Communication error:** KLIC-DI v2 is not able to establish communication with the A/C machine.

There is a LED notification, by which the LED on the device will light green when communication error is active.

- **Wrong acknowledgement:** KLIC-DI v2 received an unexpected response after sending a request to the A/C unit.

There is a LED notification, by which the LED on the device will blink every 0.5 seconds in green and stay off for other 3 seconds when wrong acknowledgement error is active.

- **Errors in the A/C unit:** errors reported by the A/C unit itself. KLIC-DI v2 can notify the KNX bus about the reported error code, although referring to the specific documentation of the A/C machine is advisable in order to obtain further information.

ETS PARAMETRISATION

The error handling function does not entail any parameter configuration. The following objects are available by default:

- Internal error objects:
 - “[AC] Internal Error: Communication”: 1-Bit object to indicate that KLIC-DI v2 is unable to access to the internal communication port.
 - “[AC] Internal Error: Wrong acknowledgement”: 1-Bit object to indicate that an unexpected response or a response with transmission errors has been received.

In case any of the above errors is detected, the corresponding object will be sent periodically (with a value of “1”) to the KNX bus. Once the error is over, it the object will be sent (once) with a value of “0”.

In case of being in an internal error situation, control orders will be ignored by KLIC-DI v2 and the status will be the previous to the error activation.

- Errors in the A/C machine:
 - “[AC] A/C unit Error: Active Error”: 1-Bit object which indicate that there is an error in the A/C unit.
 - “[AC] A/C unit Error: Error Code”: 14-Byte object that supplies the error code.

In case the A/C unit reports an error, the former object will be sent with value of “1”, while the latter will report the corresponding error code. Once the error is over, both binary and 14-byte objects will send a value of “0”. Please, refer to the user manual of the A/C unit for details about the error codes.

2.3 INPUTS

KLIC-DI v2 incorporates **two analogue/digital inputs**, each configurable as a:

- **Binary Input**, for the connection of a pushbutton or a switch/sensor.
- **Temperature Probe**, for the connection of a temperature sensor from Zennio.
- **Motion Detector**, for the connection of a motion detector from Zennio.

2.3.1 BINARY INPUT

Please refer to the “**Binary Inputs**” user manual, available in the KLIC-DI v2 product section, at the Zennio website (www.zennio.com).

2.3.2 TEMPERATURE PROBE

Please refer to the “**Temperature Probe**” user manual, available in the KLIC-DI v2 product section, at the Zennio website (www.zennio.com).

2.3.3 MOTION DETECTOR

Please refer to the “**Motion Detector**” user manual, available in the KLIC-DI v2 product section, at the Zennio website (www.zennio.com).

2.4 LOGIC FUNCTIONS

This module makes it possible to perform numeric and binary operations with incoming values received from the KNX bus, and to send the results through other communication objects specifically enabled for this purpose.

KLIC-DI v2 can implement **up to 10 different and independent functions**, each of them entirely customisable and consisting in **up to 4 consecutive operations each**.

The execution of each function can depend on a configurable **condition**, which will be evaluated every time the function is **triggered** through specific, parameterisable communication objects. The result after executing the operations of the function can also be evaluated according to certain **conditions** and afterwards sent (or not) to the KNX bus, which can be done every time the function is executed, periodically or only when the result differs from the last one.

Please refer to the “**Logic Functions**” user manual (available in the KLIC-DI v2 product section at the Zennio homepage, www.zennio.com) for detailed information about the functionality and the configuration of the related parameters.

ANNEX I. COMMUNICATION OBJECTS

- “Functional range” shows the values that, with independence of any other values permitted by the bus according to the object size, may be of any use or have a particular meaning because of the specifications or restrictions from both the KNX standard or the application program itself.

Number	Size	I/O	Flags	Data type (DPT)	Functional Range	Name	Function
1	1 Byte	I/O	C R W T U	DPT_SceneControl	0-63; 128-191	[AC] Scene	0 - 63 (Execute 1 - 64); 128 - 129 (Save 1 - 64)
2	1 Bit	I	C - W - -	DPT_Switch	0/1	[AC] On/Off	0 = Off; 1 = On
3	1 Bit	O	C R - T -	DPT_Switch	0/1	[AC] On/Off (Status)	0 = Off; 1 = On
4	2 Bytes	I	C - W - -	DPT_Value_Temp	-273.00° - 670433.28°	[AC] Temperature Setpoint	[16 ... 32] °C
5	2 Bytes	O	C R - T -	DPT_Value_Temp	-273.00° - 670433.28°	[AC] Temperature Setpoint (Status)	[16 ... 32] °C
6	2 Bytes	I	C - W - -	DPT_Value_Temp	-273.00° - 670433.28°	[AC] Temperature Setpoint: Lower Limit	[16 ... 32] °C
7	2 Bytes	O	C R - T -	DPT_Value_Temp	-273.00° - 670433.28°	[AC] Temperature Setpoint: Lower Limit (Status)	[16 ... 32] °C
8	2 Bytes	I	C - W - -	DPT_Value_Temp	-273.00° - 670433.28°	[AC] Temperature Setpoint: Upper Limit	[16 ... 32] °C
9	2 Bytes	O	C R - T -	DPT_Value_Temp	-273.00° - 670433.28°	[AC] Temperature Setpoint: Upper Limit (Status)	[16 ... 32] °C
10	1 Byte	I	C - W - -	DPT_HVACContrMode	0=Auto 1=Heat 3=Cool 9=Fan 14=Dry	[AC] Mode	0 = Automatic; 1 = Heating; 3 = Cooling; 9 = Fan; 14 = Dry
11	1 Byte	O	C R - T -	DPT_HVACContrMode	0=Auto 1=Heat 3=Cool 9=Fan 14=Dry	[AC] Mode (Status)	0 = Automatic; 1 = Heating; 3 = Cooling; 9 = Fan; 14 = Dry
12	1 Bit	I	C - W - -	DPT_Heat_Cool	0/1	[AC] Simplified Mode	0 = Cooling; 1 = Heating
13	1 Bit	O	C R - T -	DPT_Heat_Cool	0/1	[AC] Simplified Mode (Status)	0 = Cooling; 1 = Heating
14	1 Byte	I	C - W - -	DPT_Scaling	0% - 100%	[AC] Fan: Percentage Control	[0...50.20] % = S1; [50.59...100] % = S2

	1 Byte	I	C - W - -	DPT_Scaling	0% - 100%	[AC] Fan: Percentage Control	[0...33.33] % = S1; [33.73...66.67] % = S2; [67.06...100] % = S3
15	1 Byte	O	CR - T -	DPT_Scaling	0% - 100%	[AC] Fan: Percentage Control (Status)	50.20 % = S1; 100 % = S2
	1 Byte	O	CR - T -	DPT_Scaling	0% - 100%	[AC] Fan: Percentage Control (Status)	33.33 % = S1; 66.67 % = S2; 100 % = S3
16	1 Byte	I	C - W - -	DPT_Scaling	0% - 100%	[AC] Flaps: Percentage Control	0 % = Swing; [0.39...20] % = P1; [20.39...40] % = P2; [40.39...60] % = P3; [60.39...80] % = P4; [80.39...100] % = P5
17	1 Byte	O	CR - T -	DPT_Scaling	0% - 100%	[AC] Flaps: Percentage Control (Status)	0 % = Swing; 20 % = P1; 40 % = P2; 60 % = P3; 80 % = P4; 100 % = P5
18	1 Bit	I	C - W - -	DPT_Switch	0/1	[AC] Flaps: Swing	0 = Swing Off; 1 = Swing On
	1 Bit	I	C - W - -	DPT_Switch	0/1	[AC] Flaps: Swing	0 = Swing On; 1 = Swing Off
19	1 Bit	O	CR - T -	DPT_Switch	0/1	[AC] Flaps: Swing (Status)	0 = Swing Off; 1 = Swing On
	1 Bit	O	CR - T -	DPT_Switch	0/1	[AC] Flaps: Swing (Status)	0 = Swing On; 1 = Swing Off
20	2 Bytes	I	C - W - -	DPT_Value_Temp	-273.00° - 670433.28°	[AC] External Reference Temperature	[0 ... 99] °C
21	2 Bytes	O	CR - T -	DPT_Value_Temp	-273.00° - 670433.28°	[AC] Reference Temperature (Status)	Effective Control Temperature (°C)
22	2 Bytes	O	CR - T -	DPT_Value_Temp	-273.00° - 670433.28°	[AC] Indoor Unit Temperature (Status)	Return temperature measured by the indoor unit
23	2 Bytes	O	CR - T -	DPT_Value_Temp	-273.00° - 670433.28°	[AC] Master Control Temperature (Status)	Temperature measured by the master control probe
24	1 Bit	I	C - W - -	DPT_Switch	0/1	[AC] Automatic Off	0 = Deactivate; 1 = Activate
	1 Bit	I	C - W - -	DPT_Switch	0/1	[AC] Automatic Off	0 = Activate; 1 = Deactivate
25	1 Bit	O	CR - T -	DPT_Switch	0/1	[AC] Automatic Off (Status)	0 = Deactivated; 1 = Activated
	1 Bit	O	CR - T -	DPT_Switch	0/1	[AC] Automatic Off (Status)	0 = Activated; 1 = Deactivated
26	2 Bytes	I	C - W - -	DPT_TimePeriodSec	0 - 65535	[AC] Automatic Off: Delay	[0...3600] s (0 = Disabled)
27	4 Bytes	I/O	CRWT -	DPT_LongDeltaTimeSec	-2147483648 - 2147483647	[AC] Operating Time (s)	Operation time in seconds
28	2 Bytes	I/O	CRWT -	DPT_TimePeriodHrs	0 - 65535	[AC] Operating Time (h)	Operation time in hours
29	1 Bit	O	CR - T -	DPT_Alarm	0/1	[AC] Internal Error: Communication	Unable to Set AC Communication
30	1 Bit	O	CR - T -	DPT_Alarm	0/1	[AC] Internal Error: Wrong Acknowledgement	Acknowledgement Received with Errors
31	1 Bit	O	CR - T -	DPT_Alarm	0/1	[AC] AC Unit Error: Active Error	AC Unit Error
32	14 Bytes	O	CR - T -	DPT_String_ASCII		[AC] AC Unit Error: Error Code	See AC Unit Manual

33	1 Byte	O	CR-T-	DPT_MasterSlaveMode		[AC] Operation Mode Management (Status)	1 = Master Unit; 2 = Slave Unit
34, 38	2 Bytes	O	CR-T-	DPT_Value_Temp	-273.00° - 670433.28°	[Ix] Current Temperature	Temperature Sensor Value
35, 39	1 Bit	O	CR-T-	DPT_Alarm	0/1	[Ix] Overcooling	0 = No Alarm; 1 = Alarm
36, 40	1 Bit	O	CR-T-	DPT_Alarm	0/1	[Ix] Overheating	0 = No Alarm; 1 = Alarm
37, 41	1 Bit	O	CR-T-	DPT_Alarm	0/1	[Ix] Probe Error	0 = No Alarm; 1 = Alarm
42, 48	1 Bit	I	C-W--	DPT_Enable	0/1	[Ix] Input Lock	0 = Unlock; 1 = Lock
43, 49	1 Bit		C--T-	DPT_Switch	0/1	[Ix] [Short Press] 0	Sending of 0
	1 Bit		C--T-	DPT_Switch	0/1	[Ix] [Short Press] 1	Sending of 1
	1 Bit	I	C-WT-	DPT_Switch	0/1	[Ix] [Short Press] 0/1 Switching	Switching 0/1
	1 Bit		C--T-	DPT_UpDown	0/1	[Ix] [Short Press] Move Up Shutter	Sending of 0 (Up)
	1 Bit		C--T-	DPT_UpDown	0/1	[Ix] [Short Press] Move Down Shutter	Sending of 1 (Down)
	1 Bit		C--T-	DPT_UpDown	0/1	[Ix] [Short Press] Move Up/Down Shutter	Switching 0/1 (Up/Down)
	1 Bit		C--T-	DPT_Step	0/1	[Ix] [Short Press] Stop/Step Up Shutter	Sending of 0 (Stop/Step Up)
	1 Bit		C--T-	DPT_Step	0/1	[Ix] [Short Press] Stop/Step Down Shutter	Sending of 1 (Stop/Step Down)
	1 Bit		C--T-	DPT_Step	0/1	[Ix] [Short Press] Stop/Step Shutter (Switched)	Switching of 0/1 (Stop/Step Up/Down)
	4 Bit		C--T-	DPT_Control_Dimming	0x0 (Stop) 0x1 (Dec. by 100%) ... 0x7 (Dec. by 1%) 0x8 (Stop) 0xD (Inc. by 100%) ... 0xF (Inc. by 1%)	[Ix] [Short Press] Brighter	Increase Brightness
	4 Bit		C--T-	DPT_Control_Dimming	0x0 (Stop) 0x1 (Dec. by 100%) ... 0x7 (Dec. by 1%) 0x8 (Stop) 0xD (Inc. by 100%) ... 0xF (Inc. by 1%)	[Ix] [Short Press] Darker	Decrease Brightness
	4 Bit		C--T-	DPT_Control_Dimming	0x0 (Stop) 0x1 (Dec. by 100%) ... 0x7 (Dec. by 1%)	[Ix] [Short Press] Brighter/Darker	Switch Bright/Dark

					0x8 (Stop) 0xD (Inc. by 100%) ... 0xF (Inc. by 1%)		
	1 Bit		C--T-	DPT_Switch	0/1	[Ix] [Short Press] Light On	Sending of 1 (On)
	1 Bit		C--T-	DPT_Switch	0/1	[Ix] [Short Press] Light Off	Sending of 0 (Off)
	1 Bit	I	C-WT-	DPT_Switch	0/1	[Ix] [Short Press] Light On/Off	Switching 0/1
	1 Byte		C--T-	DPT_SceneControl	0-63; 128-191	[Ix] [Short Press] Run Scene	Sending of 0 - 63
	1 Byte		C--T-	DPT_SceneControl	0-63; 128-191	[Ix] [Short Press] Save Scene	Sending of 128 - 191
	1 Bit	I/O	CRWT-	DPT_Switch	0/1	[Ix] [Switch/Sensor] Edge	Sending of 0 or 1
	1 Byte		C--T-	DPT_Value_1_Ucount	0 - 255	[Ix] [Short Press] Constant Value (Integer)	0 - 255
	1 Byte		C--T-	DPT_Scaling	0% - 100%	[Ix] [Short Press] Constant Value (Percentage)	0% - 100%
	2 Bytes		C--T-	DPT_Value_2_Ucount	0 - 65535	[Ix] [Short Press] Constant Value (Integer)	0 - 65535
	2 Bytes		C--T-	9.xxx	-671088.64 - 670433.28	[Ix] [Short Press] Constant Value (Float)	Float Value
44, 50	1 Byte	I	C-W--	DPT_Scaling	0% - 100%	[Ix] [Short Press] Shutter Status (Input)	0% = Top; 100% = Bottom
	1 Byte	I	C-W--	DPT_Scaling	0% - 100%	[Ix] [Short Press] Dimming Status (Input)	0% - 100%
45, 51	1 Bit		C--T-	DPT_Switch	0/1	[Ix] [Long Press] 0	Sending of 0
	1 Bit		C--T-	DPT_Switch	0/1	[Ix] [Long Press] 1	Sending of 1
	1 Bit	I	C-WT-	DPT_Switch	0/1	[Ix] [Long Press] 0/1 Switching	Switching 0/1
	1 Bit		C--T-	DPT_UpDown	0/1	[Ix] [Long Press] Move Up Shutter	Sending of 0 (Up)
	1 Bit		C--T-	DPT_UpDown	0/1	[Ix] [Long Press] Move Down Shutter	Sending of 1 (Down)
	1 Bit		C--T-	DPT_UpDown	0/1	[Ix] [Long Press] Move Up/Down Shutter	Switching 0/1 (Up/Down)
	1 Bit		C--T-	DPT_Step	0/1	[Ix] [Long Press] Stop/Step Up Shutter	Sending of 0 (Stop/Step Up)
	1 Bit		C--T-	DPT_Step	0/1	[Ix] [Long Press] Stop/Step Down Shutter	Sending of 1 (Stop/Step Down)
	1 Bit		C--T-	DPT_Step	0/1	[Ix] [Long Press] Stop/Step Shutter (Switched)	Switching of 0/1 (Stop/Step Up/Down)
	4 Bit		C--T-	DPT_Control_Dimming	0x0 (Stop) 0x1 (Dec. by 100%) ... 0x7 (Dec. by 1%)	[Ix] [Long Press] Brighter	Long Pr. -> Brighter; Release -> Stop

				0x8 (Stop) 0xD (Inc. by 100%) ... 0xF (Inc. by 1%)		
	4 Bit		C--T-	DPT_Control_Dimming	0x0 (Stop) 0x1 (Dec. by 100%) ... 0x7 (Dec. by 1%) 0x8 (Stop) 0xD (Inc. by 100%) ... 0xF (Inc. by 1%)	[Ix] [Long Press] Darker Long Pr. -> Darker; Release -> Stop
	4 Bit		C--T-	DPT_Control_Dimming	0x0 (Stop) 0x1 (Dec. by 100%) ... 0x7 (Dec. by 1%) 0x8 (Stop) 0xD (Inc. by 100%) ... 0xF (Inc. by 1%)	[Ix] [Long Press] Brighter/Darker Long Pr. -> Brighter/Darker; Release -> Stop
	1 Bit		C--T-	DPT_Switch	0/1	[Ix] [Long Press] Light On Sending of 1 (On)
	1 Bit		C--T-	DPT_Switch	0/1	[Ix] [Long Press] Light Off Sending of 0 (Off)
	1 Bit	I	C-WT-	DPT_Switch	0/1	[Ix] [Long Press] Light On/Off Switching 0/1
	1 Byte		C--T-	DPT_SceneControl	0-63; 128-191	[Ix] [Long Press] Run Scene Sending of 0 - 63
	1 Byte		C--T-	DPT_SceneControl	0-63; 128-191	[Ix] [Long Press] Save Scene Sending of 128 - 191
	1 Bit	O	CR-T-	DPT_Alarm	0/1	[Ix] [Switch/Sensor] Alarm: Breakdown or Sabotage 1 = Alarm; 0 = No Alarm
	2 Bytes		C--T-	9.xxx	-671088.64 - 670433.28	[Ix] [Long Press] Constant Value (Float) Float Value
	2 Bytes		C--T-	DPT_Value_2_Ucount	0 - 65535	[Ix] [Long Press] Constant Value (Integer) 0 - 65535
	1 Byte		C--T-	DPT_Scaling	0% - 100%	[Ix] [Long Press] Constant Value (Percentage) 0% - 100%
	1 Byte		C--T-	DPT_Value_1_Ucount	0 - 255	[Ix] [Long Press] Constant Value (Integer) 0 - 255
46, 52	1 Bit		C--T-	DPT_Trigger	0/1	[Ix] [Long Press/Release] Stop Shutter Release -> Stop Shutter
47, 53	1 Byte	I	C-W--	DPT_Scaling	0% - 100%	[Ix] [Long Press] Dimming Status (Input) 0% - 100%
	1 Byte	I	C-W--	DPT_Scaling	0% - 100%	[Ix] [Long Press] Shutter Status (Input) 0% = Top; 100% = Bottom
54	1 Byte	I	C-W--	DPT_SceneNumber	0 - 63	[Motion Detector] Scene Input Scene Value

55	1 Byte		C - - T -	DPT_SceneControl	0-63; 128-191	[Motion Detector] Scene Output	Scene Value
56, 85	1 Byte	O	CR - T -	DPT_Scaling	0% - 100%	[Ix] Luminosity	0-100%
57, 86	1 Bit	O	CR - T -	DPT_Alarm	0/1	[Ix] Open Circuit Error	0 = No Error; 1 = Open Circuit Error
58, 87	1 Bit	O	CR - T -	DPT_Alarm	0/1	[Ix] Short Circuit Error	0 = No Error; 1 = Short Circuit Error
59, 88	1 Byte	O	CR - T -	DPT_Scaling	0% - 100%	[Ix] Presence State (Scaling)	0-100%
60, 89	1 Byte	O	CR - T -	DPT_HVACMode	1=Comfort 2=Standby 3=Economy 4=Building Protection	[Ix] Presence State (HVAC)	Auto, Comfort, Standby, Economy, Building Protection
61, 90	1 Bit	O	CR - T -	DPT_Switch	0/1	[Ix] Presence State (Binary)	Binary Value
	1 Bit	O	CR - T -	DPT_Start	0/1	[Ix] Presence: Slave Output	1 = Motion Detected
62, 91	1 Bit	I	C - W - -	DPT_Window_Door	0/1	[Ix] Presence Trigger	Binary Value to Trigger the Presence Detection
63, 92	1 Bit	I	C - W - -	DPT_Start	0/1	[Ix] Presence: Slave Input	0 = Nothing; 1 = Detection from slave device
64, 93	2 Bytes	I	C - W - -	DPT_TimePeriodSec	0 - 65535	[Ix] Presence: Waiting Time	0-65535 s.
65, 94	2 Bytes	I	C - W - -	DPT_TimePeriodSec	0 - 65535	[Ix] Presence: Listening Time	1-65535 s.
66, 95	1 Bit	I	C - W - -	DPT_Enable	0/1	[Ix] Presence: Enable	According to parameters
67, 96	1 Bit	I	C - W - -	DPT_DayNight	0/1	[Ix] Presence: Day/Night	According to parameters
68, 97	1 Bit	O	CR - T -	DPT_Occupancy	0/1	[Ix] Presence: Occupancy State	0 = Not Occupied; 1 = Occupied
69, 98	1 Bit	I	C - W - -	DPT_Start	0/1	[Ix] External Motion Detection	0 = Nothing; 1 = Motion detected by an external sensor
70, 75, 80, 99, 104, 109	1 Byte	O	CR - T -	DPT_Scaling	0% - 100%	[Ix] [Cx] Detection State (Scaling)	0-100%
71, 76, 81, 100, 105, 110	1 Byte	O	CR - T -	DPT_HVACMode	1=Comfort 2=Standby 3=Economy 4=Building Protection	[Ix] [Cx] Detection State (HVAC)	Auto, Comfort, Standby, Economy, Building Protection
72, 77, 82, 101, 106, 111	1 Bit	O	CR - T -	DPT_Switch	0/1	[Ix] [Cx] Detection State (Binary)	Binary Value
73, 78, 83, 102, 107, 112	1 Bit	I	C - W - -	DPT_Enable	0/1	[Ix] [Cx] Enable Channel	According to parameters
74, 79, 84, 103, 108, 113	1 Bit	I	C - W - -	DPT_Switch	0/1	[Ix] [Cx] Force State	0 = No Detection; 1 = Detection
114, 115, 116, 117, 118, 119, 120, 121, 122, 123, 124, 125, 126, 127, 128, 129, 130, 131, 132, 133, 134, 135, 136, 137, 138, 139, 140, 141, 142, 143, 144, 145	1 Bit	I	C - W - -	DPT_Bool	0/1	[LF] (1-Bit) Data Entry x	Binary Data Entry (0/1)

146, 147, 148, 149, 150, 151, 152, 153, 154, 155, 156, 157, 158, 159, 160, 161	1 Byte	I	C - W - -	DPT_Value_1_Ucount	0 - 255	[LF] (1-Byte) Data Entry x	1-Byte Data Entry (0-255)
162, 163, 164, 165, 166, 167, 168, 169, 170, 171, 172, 173, 174, 175, 176, 177	2 Bytes	I	C - W - -	DPT_Value_2_Ucount	0 - 65535	[LF] (2-Byte) Data Entry x	2-Byte Data Entry
178, 179, 180, 181, 182, 183, 184, 185	4 Bytes	I	C - W - -	DPT_Value_4_Count	-2147483648 - 2147483647	[LF] (4-Byte) Data Entry x	4-Byte Data Entry
186, 187, 188, 189, 190, 191, 192, 193, 194, 195	1 Bit	O	CR - T -	DPT_Bool	0/1	[LF] Function x - Result	(1-Bit) Boolean
	1 Byte	O	CR - T -	DPT_Value_1_Ucount	0 - 255	[LF] Function x - Result	(1-Byte) Unsigned
	2 Bytes	O	CR - T -	DPT_Value_2_Ucount	0 - 65535	[LF] Function x - Result	(2-Byte) Unsigned
	4 Bytes	O	CR - T -	DPT_Value_4_Count	-2147483648 - 2147483647	[LF] Function x - Result	(4-Byte) Signed
	1 Byte	O	CR - T -	DPT_Scaling	0% - 100%	[LF] Function x - Result	(1-Byte) Percentage
	2 Bytes	O	CR - T -	DPT_Value_2_Count	-32768 - 32767	[LF] Function x - Result	(2-Byte) Signed
	2 Bytes	O	CR - T -	9.xxx	-671088.64 - 670433.28	[LF] Function x - Result	(2-Byte) Float
196	1 Bit		C - - T -	DPT_Trigger	0/1	[Heartbeat] Object to Send '1'	Sending of '1' Periodically
197	1 Bit		C - - T -	DPT_Trigger	0/1	[Heartbeat] Device Recovery	Send 0
198	1 Bit		C - - T -	DPT_Trigger	0/1	[Heartbeat] Device Recovery	Send 1



Join and send us your inquiries
about Zennio devices:

<https://support.zennio.com>

Zennio Avance y Tecnología S.L.
C/ Río Jarama, 132. Nave P-8.11
45007 Toledo, Spain.

Tel. +34 925 232 002.

www.zennio.com
info@zennio.com