

FEATURES

- Bidirectional communication with Daikin HVAC units
- 2 analog/digital inputs
- 10 logic functions
- Total data saving on KNX bus failure
- Integrated KNX BCU (TP1-256)
- Dimensions 67 x 90 x 36 mm (2 DIN units)
- DIN rail mounting according to IEC 60715 TH35, with fixing clamp
- Conformity with CE, UKCA, RCM directives (marks on the right side)

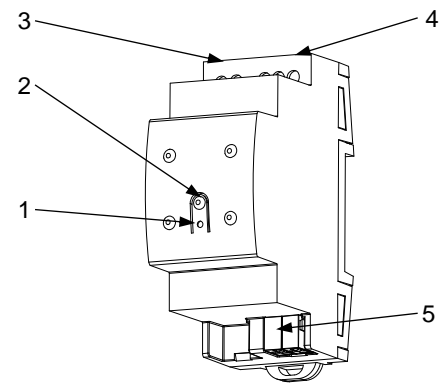

Figure 1: KLIC-DI v2

1. Programming LED	2. Programming button	3. 2-wire communication with HVAC unit
4. Inputs	5. KNX connector	

Programming button: short press to set programming mode. If this button is held while plugging the device into the KNX bus, it enters the safe mode.

Programming LED: programming mode indicator (red). When the device enters the safe mode, it blinks (red) every half second. During the start-up (reset or after KNX bus failure) and if the device is not in safe mode, it emits a red flash. The HVAC unit communication error is notified through a green light and the wrong acknowledgement error through a green blinking sequence.

GENERAL SPECIFICATIONS

CONCEPT		DESCRIPTION		
Type of device		Electric operation control device		
KNX supply	Voltage (typical)	29 VDC SELV		
	Voltage range	21-31 VDC		
	Maximum consumption	Voltage	mA	mW
		29 VDC (typical)	4.5	130.5
24 VDC ¹	10	240		
Connection type		Typical TP1 bus connector for 0.8 mm Ø rigid cable		
External power supply		Not required		
Operation temperature		0 .. +55 °C		
Storage temperature		-20 .. +55 °C		
Operation humidity		5 .. 95%		
Storage humidity		5 .. 95%		
Complementary characteristics		Class B		
Protection class / Overvoltage category		II / III (4000 V)		
Operation type		Continuous operation		
Device action type		Type 1		
Electrical stress period		Long		
Degree of protection / Pollution degree		IP20 / 2 (clean environment)		
Installation		Independent device to be mounted inside electrical panels with DIN rail (IEC 60715)		
Minimum clearances		Not required		
Response on KNX bus failure		Data saving according to parameterization		
Response on KNX bus restart		Data recovery according to parameterization		
Operation indicator		The programming LED indicates programming mode (red), HVAC unit communication error (green) or error due to wrong acknowledgement (green blinking sequence)		
Weight		114 g		
PCB CTI index		175 V		
Housing material / Ball pressure test temperature		PC FR V0 halogen free / 75 °C (housing) - 125 °C (connectors)		

¹ Maximum consumption in the worst-case scenario (KNX Fan-In model).

INPUTS SPECIFICATIONS AND CONNECTIONS	
CONCEPT	DESCRIPTION
Number of inputs	2
Inputs per common	2
Operation voltage	+3.3 VDC in the common
Operation current	1 mA @ 3.3 VDC (per input)
Switching type	Dry voltage contacts between input and common
Connection method	Screw terminal block (0.4 Nm max.)
Cable cross-section	0.5-2.5 mm ² (IEC) / 26-12 AWG (UL)
Maximum cable length	30 m
NTC accuracy (@ 25 °C) ²	±0.5 °C
Temperature resolution	0.1 °C
Maximum response time	10 ms

² For Zennio temperature probes.

INPUTS CONNECTION

Any combination of the following accessories is allowed in the inputs:

Temperature Probe**

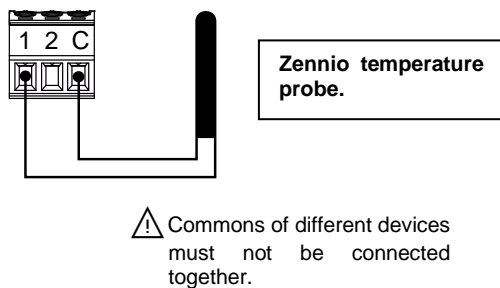

Motion Sensor

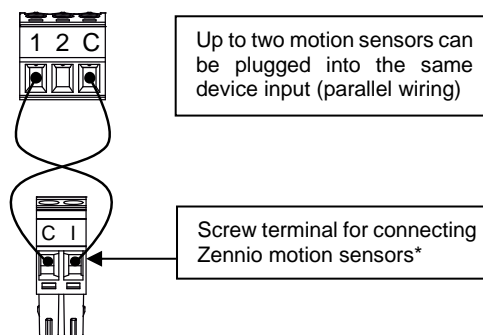

Switch/Sensor/ Push button

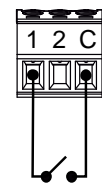

* In case of using ZN110-DETEC-P sensor, its micro switch number 2 must be in **Type B position**.

**Zennio temperature probe or any NTC with known resistance values at three points in the range [-55, 150 °C].

HVAC EQUIPMENT CONNECTION SPECIFICATION AND CONNECTIONS	
CONCEPT	DESCRIPTION
Maximum cable length	100 m
Connection method	Screw terminal block (0.4 Nm max.)
Cable cross-section	0.5-2.5 mm ² (IEC) / 26-12 AWG (UL)

WIRING DIAGRAM

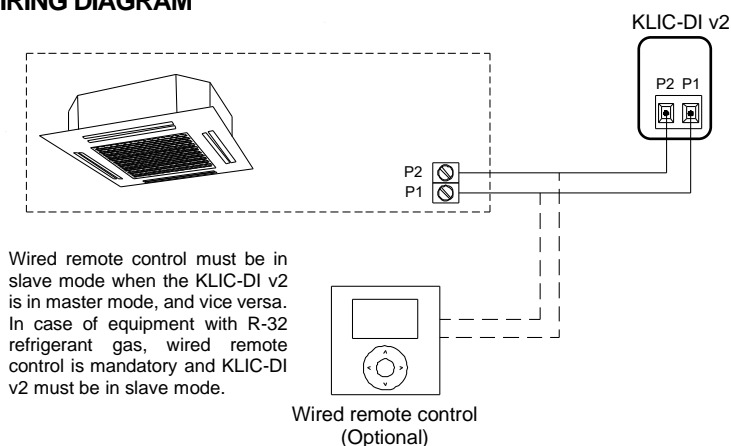

Attaching KLIC-DI v2 to DIN rail:

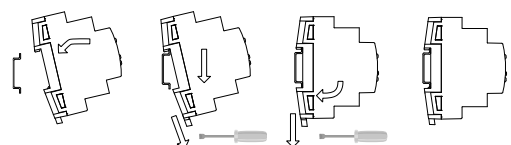

Removing KLIC-DI v2 from DIN rail:

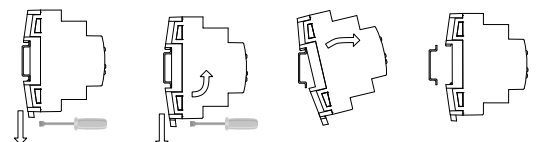

SAFETY INSTRUCTIONS AND ADDITIONAL NOTES

- Installation should only be performed by qualified professionals according to the laws and regulations applicable in each country.
- Do not connect the mains voltage nor any other external voltage to any point of the KNX bus; it would represent a risk for the entire KNX system. The facility must have enough insulation between the mains (or auxiliary) voltage and the KNX bus or the wires of other accessories, in case of being installed.
- Once the device is installed (in the panel or box), it must not be accessible from outside.
- Keep the device away from water (condensation over the device included) and do not cover it with clothes, paper or any other material while in use.
- The WEEE logo means that this device contains electronic parts and it must be properly disposed of by following the instructions at <https://www.zennio.com/en/legal/wEEE-regulation>.
- This device contains software subject to specific licences. For details, please refer to <https://zennio.com/licenses>.