

	<h2>application software</h2>	
<ul style="list-style-type: none"> ▲ Manufacturers ▲ Hager Electro ▲ RF devices <li style="background-color: #e0f0e0; padding: 2px;">Inputs / Outputs 	<h3>Radio ON/OFF Input/Output products</h3> <p><i>Electrical/Mechanical characteristics: see product user manual</i></p>	

	Product reference	Product designation	Application software ref	TP device Radio device
	TRM690G	Output 200W 2 lines + 2-fold embedded input KNX radio	STRM690G	☞
	TRM693G	1 output 3A 230V + 2-fold embedded input KNX radio	STRM693G	☞
	TRM694G	1 free outlet with 4A potential + 2-fold embedded input KNX radio	STRM694G	☞

Content

1. Presentation.....	4
1.1 General.....	4
1.2 About the program ETS.....	4
1.2.1 ETS compatibility.....	4
1.2.2 Application descriptions.....	4
1.2.3 Plugin TR131.....	4
1.3 Easy tool software appearance.....	4
2. General Description.....	5
2.1 Installation of the device.....	6
2.1.1 Overview presentation.....	6
2.1.2 Description of the device.....	7
2.2 Function modules of the application.....	8
2.2.1 Output ON/OFF.....	8
2.2.2 Input.....	10
3. Programming by ETS.....	12
3.1 Parameters.....	12
3.1.1 Fixed parameters.....	12
3.1.2 Functions of each switch actuator.....	12
3.1.2.1 Timer.....	12
3.1.2.2 Priority.....	14
3.1.2.3 Automatic control.....	15
3.1.2.4 Load shedding.....	16
3.1.2.5 Scene.....	17
3.1.3 Input operation mode.....	19
3.1.3.1 Toggle switch.....	20
3.1.3.2 ON/OFF.....	21
3.1.3.3 Timer.....	22
3.1.3.4 Shutter and blind.....	23
3.1.3.5 Dimming.....	28
3.1.3.6 Heating.....	32
3.1.3.7 Priority.....	34
3.1.3.8 Scene.....	35
3.1.3.9 Alarm.....	37
3.1.3.10 Automatic control deactivation.....	38
3.1.3.11 Load shedding.....	38
3.1.3.12 Windows contact.....	38
3.1.3.13 Tariff.....	39
3.2 Communication objects.....	40
3.2.1 Output communication objects ON/OFF.....	40
3.2.1.1 ON/OFF.....	40
3.2.1.2 Status indication.....	41
3.2.1.3 Timer.....	41
3.2.1.4 Priority.....	41
3.2.1.5 Scene.....	42
3.2.1.6 ON/OFF automatic control.....	42
3.2.1.7 Automatic control deactivation.....	43
3.2.1.8 Load shedding.....	43
3.2.2 Communication objects by input.....	44
3.2.2.1 ON/OFF and toggle switch.....	48
3.2.2.2 Timer.....	48
3.2.2.3 Shutter and blind.....	48
3.2.2.4 Dimming.....	50
3.2.2.5 Heating.....	51
3.2.2.6 Priority.....	52
3.2.2.7 Scene.....	52
3.2.2.8 Alarm.....	53
3.2.2.9 Automatic control.....	53
3.2.2.10 Load shedding.....	53
3.2.2.11 Windows contact.....	54
3.2.2.12 Tariff.....	54
3.3 Configuration with media coupler.....	55
4. Programming by Easy Tool.....	59
4.1 Product overview.....	59
4.2 Repeater Function.....	64
4.3 Product functions at output.....	64
4.3.1 ON/OFF.....	64
4.3.2 Timer.....	65
4.3.3 Priority.....	67
4.3.4 Automatic control.....	68

4.3.5 Load shedding.....	70
4.3.6 Scene.....	71
4.4 Input operation mode.....	74
4.4.1 Lighting.....	74
4.4.1.1 Toggle switch.....	76
4.4.1.2 Timer.....	77
4.4.1.3 Priority.....	78
4.4.1.4 ON/OFF Automatic control	79
4.4.1.5 Load shedding	80
4.4.2 Relative or absolute dimming (Brightness value).....	80
4.4.2.1 Dimming.....	81
4.4.2.2 Dimming automatic control	82
4.4.3 Shutter/blind	84
4.4.3.1 Up/down.....	85
4.4.3.2 Shutter or blind angle.....	87
4.4.3.3 Priority.....	90
4.4.3.4 Alarm	90
4.4.3.5 Shutter/blind automatic control	91
4.4.4 Heating/Cooling.....	94
4.4.4.1 Setpoint selection	95
4.4.4.2 Heating/Cooling	96
4.4.4.3 Priority.....	97
4.4.4.4 Heating automatic control	98
4.4.4.5 Metering.....	99
4.4.5 Automatic control deactivation	100
4.4.6 Scene.....	101
5. Factory reset.....	103
5.1 Factory reset by ETS via the media coupler.....	103
5.2 Factory reset on the product.....	103
6. Characteristics	104

1. Presentation

1.1 General

The purpose of this manual is to describe the operation and configuration of the KNX-devices using the ETS program. It consists of 4 parts:

- General information.
- The parameters and KNX objects available.
- The Easy tool configurations are available.
- Technical characteristics.

1.2 About the program ETS

1.2.1 ETS compatibility

The application programs are compatible with ETS4 and ETS5. They can be downloaded from our website under the order number.

ETS Version	File extension of compatible files
ETS4 (V4.1.8 or higher)	*.knxprod
ETS5	*.knxprod

1.2.2 Application descriptions

Application	Product reference
STRM690G	TRM690G
STRM693G	TRM693G
STRM694G	TRM694G



1.2.3 Plugin TR131

The TR131 media coupler enables configuration by ETS of RF devices for a KNX radio installation or a mixed KNX installation including RF devices and wired buses. The TR131 Plugin must be installed in the ETS software to configure the radio products..

1.3 Easy tool software appearance

This product can also be configured using the TXA100 configuration tool. It is composed of a TJA665 configuration server. It is essential to update the configuration server software version. (Please refer to the TXA100 user manual).

2. General Description

All radio transmitters referred to in this document are radio quicklink  products. They can be recognised by the configuration cfg push button with which they are all equipped. Quicklink  indicates the configuration without tools mode.

These products can also be configured in E mode by the USB configurer or in S mode by ETS via the media coupler.

Within the same installation, a single configuration mode may be used.

To re-use a product which has already been programmed in another installation, whatever the configuration mode, a factory reset must be performed on the product.

2.1 Installation of the device

2.1.1 Overview presentation

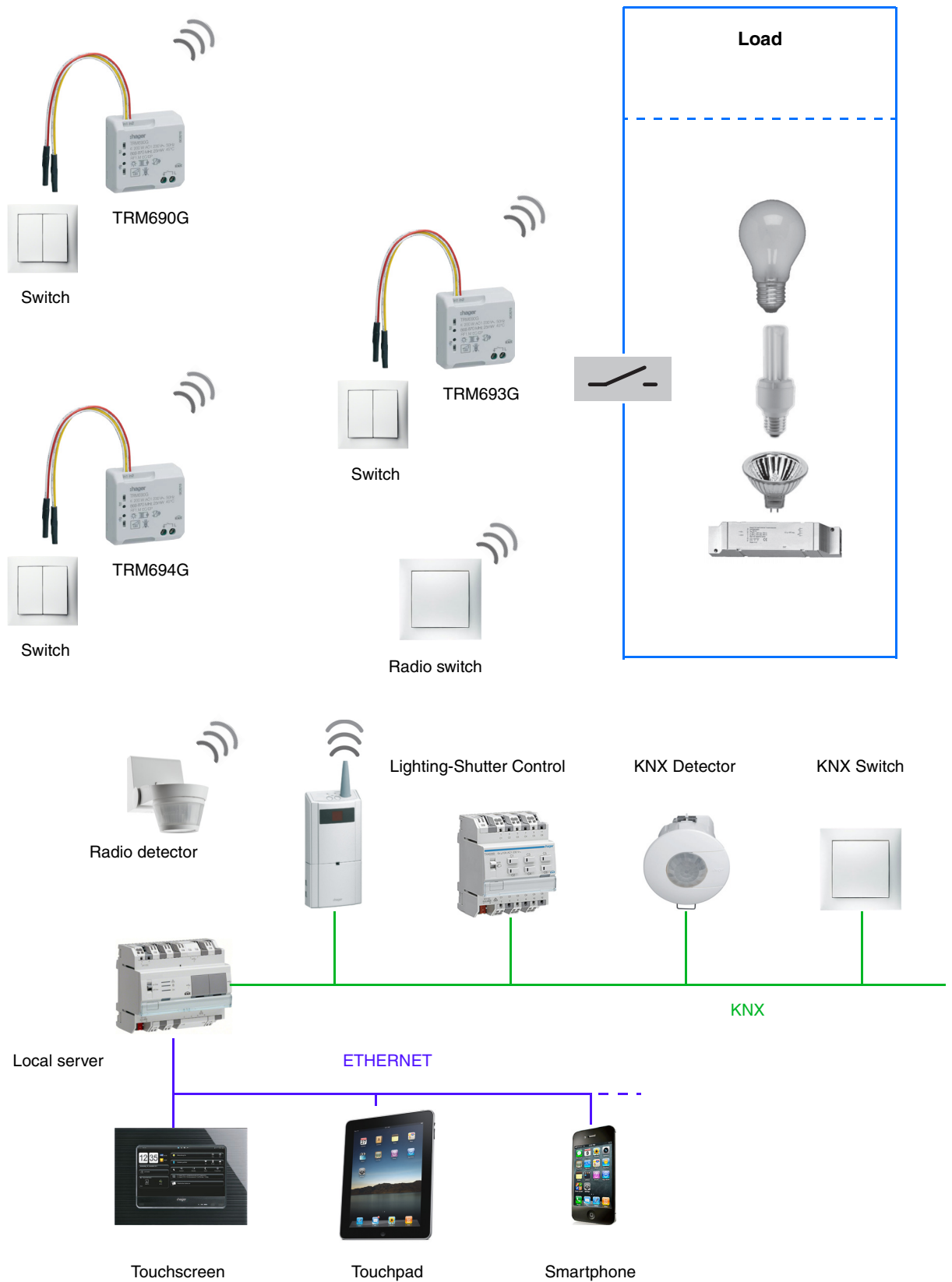

2.1.2 Description of the device

- TRM690G

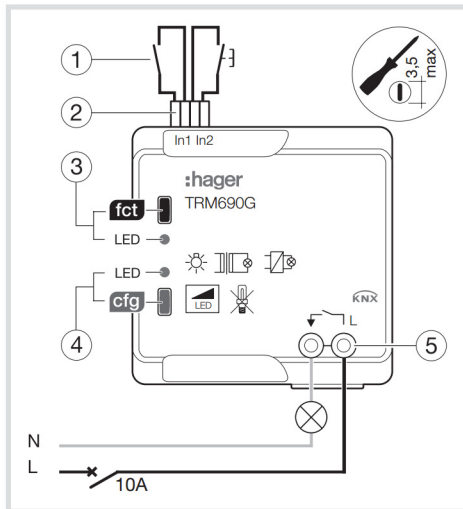

- ① Pushbutton or standard switch
- ② Wires for connecting the 2 inputs for a switch or pushbutton
- ③ Pushbutton and feature LED **fct** of output.
- ④ Pushbutton and configuration LED **cfg**
- ⑤ Connector block:
 - L : Phase 230V~
 - ↓ : Output connection, 230 V

- TRM693G

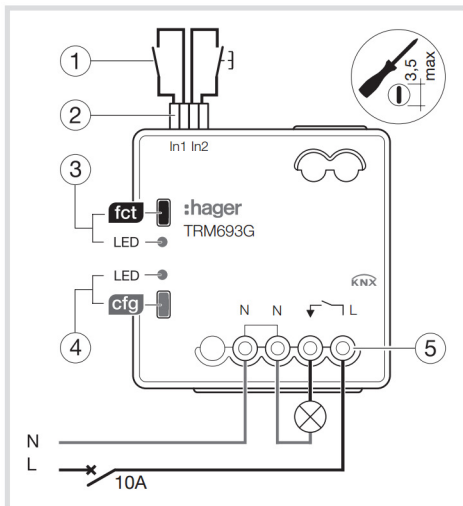

- ① Pushbutton or standard switch
- ② Wires for connecting the 2 inputs for a switch or pushbutton
- ③ Pushbutton and feature LED **fct** of output
- ④ Pushbutton and configuration LED **cfg**
- ⑤ Connector block:
 - L : Phase 230V~
 - N : Neutral
 - ↓ : Contact output 230V

- TRM694G

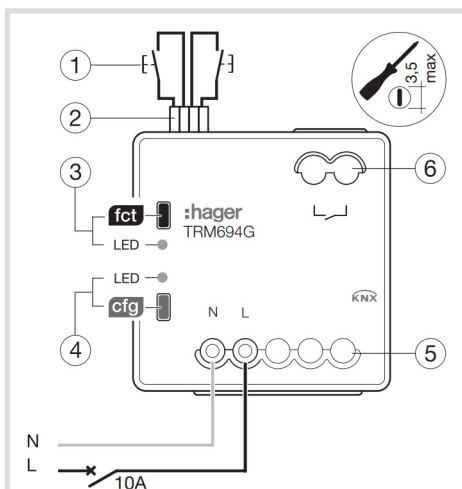

- ① Pushbutton or standard switch
- ② Wires for connecting the 2 inputs for a switch or pushbutton
- ③ Pushbutton and feature LED **fct** of output
- ④ Pushbutton and configuration LED **cfg**
- ⑤ Connector block:
 - L : Phase 230V~
 - N : Neutral
- ⑥ : SELV-compatible floating contact output

2.2 Function modules of the application

2.2.1 Output ON/OFF

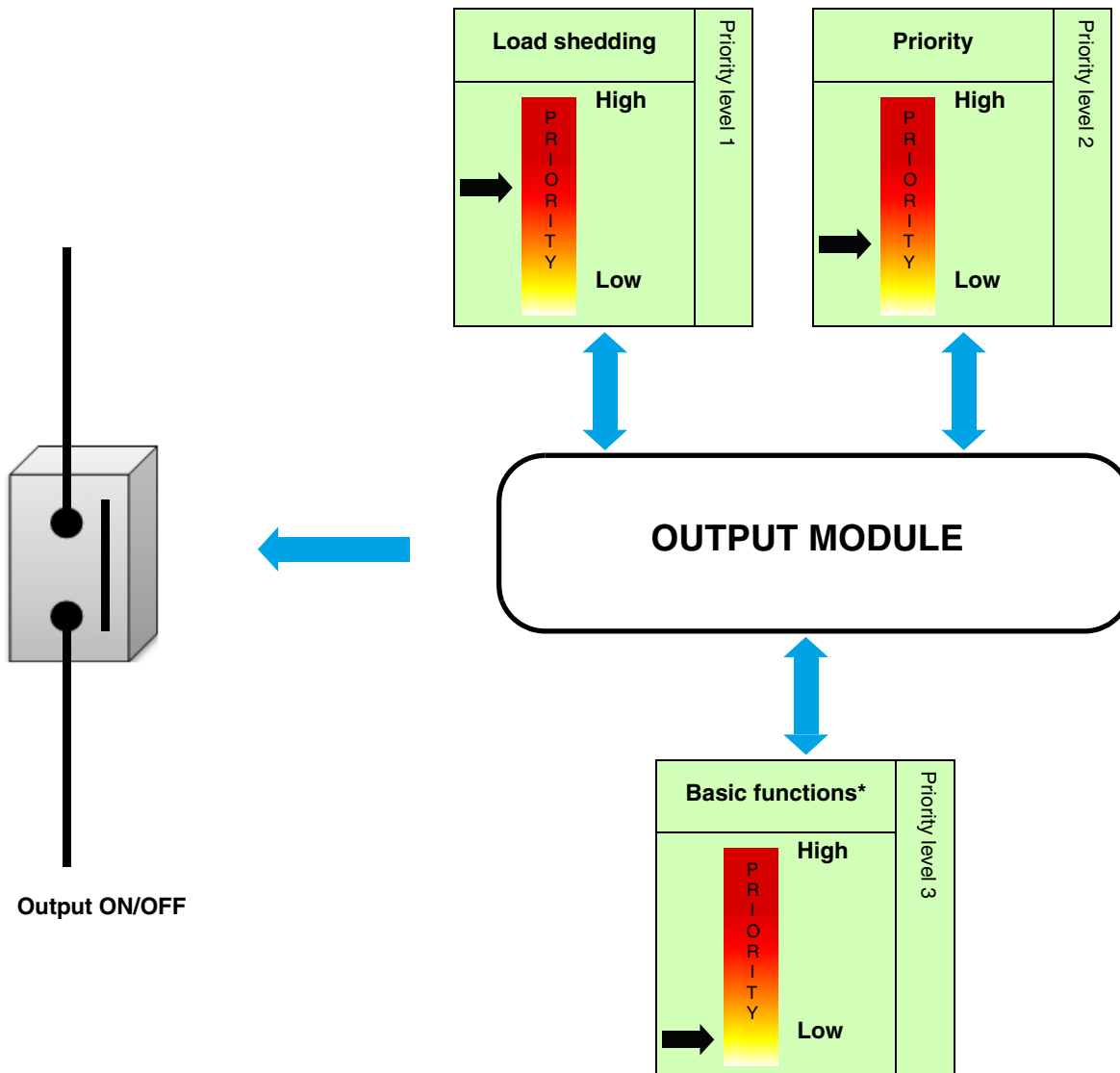

* ON/OFF - Timer - Scene: The last command received will have priority.

The applications allow individual configuration of the device outputs.

The most important functions are:

- **ON/OFF**

An output can be switched on or off using the ON/OFF function. The command can come from switches, buttons or other control inputs.

■ Timer

The Timer function is used to switch an output on for a programmable period. A programmable Cut-OFF pre-warning announces the end of the delay time by a 1-second inversion of the output status. The timer duration can be modified via the bus KNX.

■ Priority

The Priority function is used to force the output into a defined state. The Priority function is controlled with a 2-bit command.

Priority: **Load shedding** > **Priority** > Basic function.

Application: Keeping lighting on for security reasons.

■ Automatic control

The Automatic control function is used to command an output in parallel to the ON/OFF function. The two functions have the same level of priority. The last command received will act on the status of the output.

An additional command object is used to activate or deactivate the Automatic control.

■ Load shedding

The Load shedding function is used to force an output to OFF. Load shedding is activated by receipt of a 1-byte command.

Priority: **Load shedding** > Priority > Basic function.

This command has the highest priority. No other command is taken into account if the mode is active. The status of the output is memorised but not applied. At the end of load shedding, the output is switched to the theoretical status without Load shedding (memorisation).

Note: The Load shedding function is only available in products TRM693G and TRM694G.

■ Scene

The Scene function is used to switch groups of outputs into a configurable predefined state. Pressing a push button activates a scene.

A scene is activated by receipt of a 1-byte command.

Each output can be included in 64 different scenes.

■ Status indication

The Status indication sends the switching status of the individual output contact on the KNX bus.

Communication objects

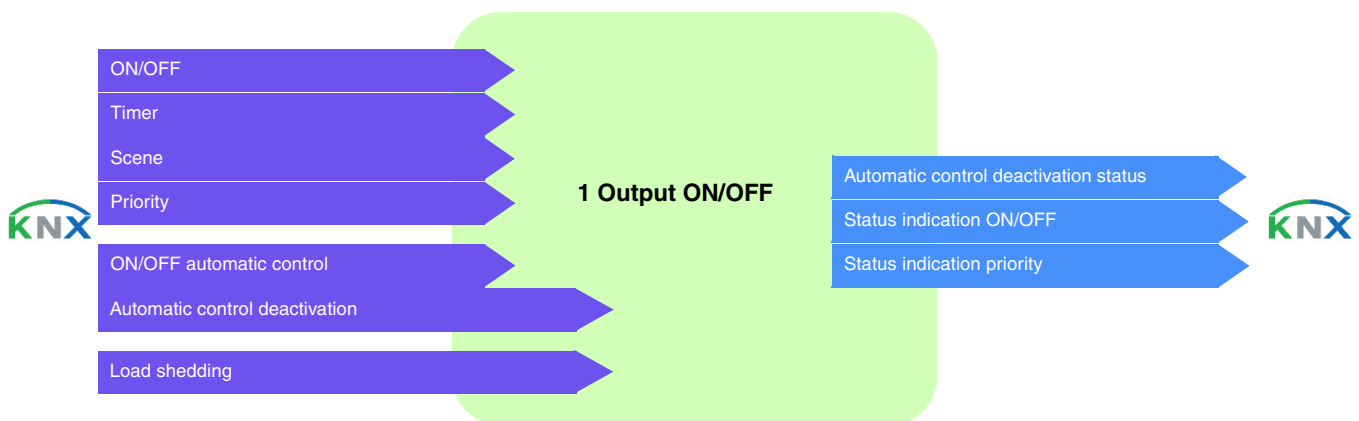

2.2.2 Input

The command organs connected to inputs (remote switch, switch, automation) enable lighting, shutters, blinds, heating and scenes commands.

The most important functions are:

■ Toggle switch

The Toggle switch function consists in inverting the output status after each press.

■ ON/OFF

The ON/OFF function a lighting, rolling shutter or heating circuit to be switched on or off. The command can come from switches, push-buttons or automations.

■ Timer

The Timer function enables a lighting, rolling shutter or heating circuit to be switched on or off for a programmable length of time. A short press on the push-button re-launches the timer. The timer can be interrupted before the end of the time by a long press. A programmable Cut-OFF pre-warning announces the end of the delay time by a 1-second inversion of the output status.

■ Shutter/blind

This function enables a rolling shutter or a blind to be controlled from 2 push-buttons. The Up/Down command (**Up/Down** object) is issued by a long press on the button. The Stop/Tilt function issues the object **Tilt/Stop** (short press).

■ Dimming

This function enables a light to be dimmed from one or two input contacts. The ON/OFF function issues the object **ON/OFF** (short press). The Dimming function issues the object **Dimming** (long press).

■ Heating

This function enables a heating or air-conditioning instruction (Auto, Comfort, Economy, Night setpoint, Frost protection) to be selected. It enables instruction exceptions to be issued in order to increase or reduce the temperature. The command can come from switches, push-buttons or automations.

■ Priority

The Priority function enables an input to be forced into a defined state. The priority action depends on the type of application commanded: Lighting ON/OFF, Rolling shutter, Heating.

■ Scene

This function enables scenes to be saved or selected. These concern different types of output (lighting, blind, shutter, heating) to create ambiances or scenarios (leaving scenario, reading ambiance etc.).

■ Alarms

The wind, rain and freeze Alarm functions enable alarms to be issued on a cyclical basis to the bus from automations (anemometer, rain detector, twilight switch, etc.).

■ Automatic control

The Automatic control function enables an output to be controlled in parallel to the standard control. An additional command object (Automatic control deactivation) is used to activate or deactivate Automatic control.

■ Load shedding

The Load shedding function is used to force an output to OFF. Load shedding is activated by receipt of a 1-byte command. At the end of load shedding, the output is switched to the theoretical status without Load shedding (memorisation).

■ Windows contact

The Window contact function enables the window opening/closing information to be sent to the KNX bus.

■ **Tariff**

The Tariff function enables T1/T2 tariff information to be sent to the KNX bus.

Communication objects

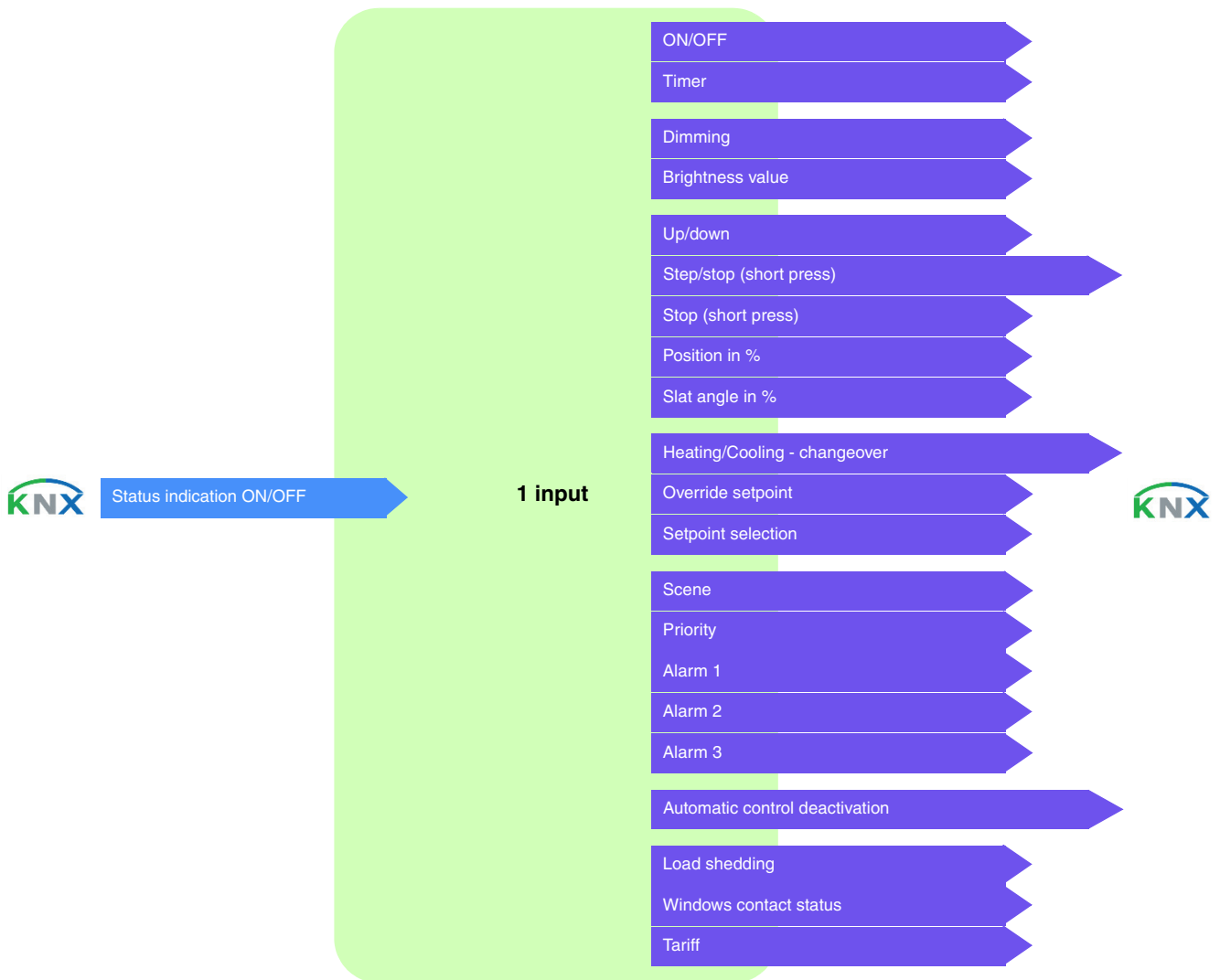

3. Programming by ETS

The function of the different devices only differs in the number of outputs. For this reason, only one device or one output will ever be described.

3.1 Parameters

3.1.1 Fixed parameters

The fixed parameters define the operating mode of the output relays.

Parameter	Description	Value
Output contact	On receipt of an ON command: The output relay closes.	Normally open
Parameters overwrite at next download (scenes)	The parameter values stored in the device will be overwritten with the ETS configured values at the next download.	Active
Status after priority	At the end of the priority, the output is: Switched back to the status before priority was activated.	Status before priority
Status after ETS download	The output status remains unchanged after ETS download. <i>Note: During ETS-parameters download, the outputs remain unchanged.</i>	Maintain status
Status at supply return	The output status remains unchanged when the power is turned back on. <i>Note: The priority functions that were present before the bus power cut are no longer active (Load shedding, Priority).</i>	Maintain status

3.1.2 Functions of each switch actuator

3.1.2.1 Timer

The Timer function is used to switch on a lighting circuit for a programmable period. The timer may be interrupted before expiry of the delay time. A programmable Cut-OFF pre-warning announces the end of the delay time by a 1-second inversion of the output status.

Timer

Timer duration

Cut-OFF pre-warning

Parameter	Description	Value
Timer duration	This parameter determines the timer duration.	Not active, 1 s, 2 s, 3 s, 5 s, 10 s, 15 s, 20 s, 30 s, 45 s, 1 min, 1 min 15 s, 1 min 30 s, 2 min, 2 min 30 s, 3 min* , 5 min, 15 min, 20 min, 30 min, 1 h, 2 h, 3 h, 5 h, 12 h, 24 h

* Default value

Parameter	Description	Value
Cut-OFF pre-warning	This parameter determines the lead time of the cut-OFF pre-warning.	Not active, 15 s, 30 s* , 1 min

Operating principle:

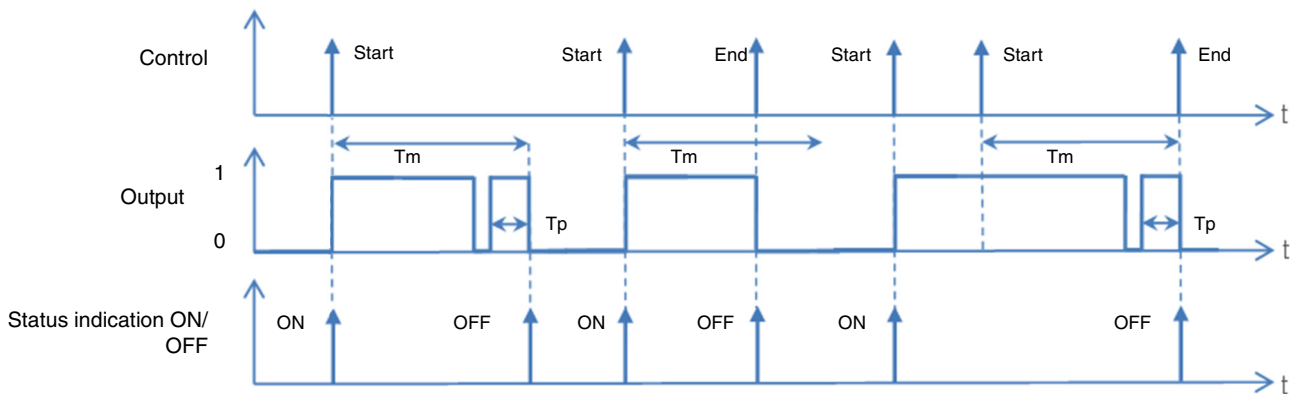

T_m : Timer duration
 T_p : Pre-warning lead time

Note: If the lead time of the cut-OFF pre-warning is greater than the duration of the timer, the cut-OFF pre-warning is not triggered.

Communication objects: **2 - Output - Timer (1 Bit – 1.001 DPT_Switch)**
 10 - Output - Timer (1 Bit – 1.001 DPT_Switch)

* Default value

3.1.2.2 Priority

The Priority function is used to force the output into a defined state.

Priority: Load shedding > **Priority** > Basic function.

Only a Priority OFF command authorizes the output for control.

At the end of the priority, the output returns to the status it had before the priority (Memorisation function).

The device responds to telegrams received via the **Priority** object, as given in the following table:

Telegram received by the priority operation object			Output behaviour
Hexadecimal Value	Binary Value		
	Bit 1 (MSB)	Bit 0 (LSB)	
00	0	0	End of the priority
01	0	1	End of the priority
02	1	0	Priority OFF
03	1	1	Priority ON

Operating principle:

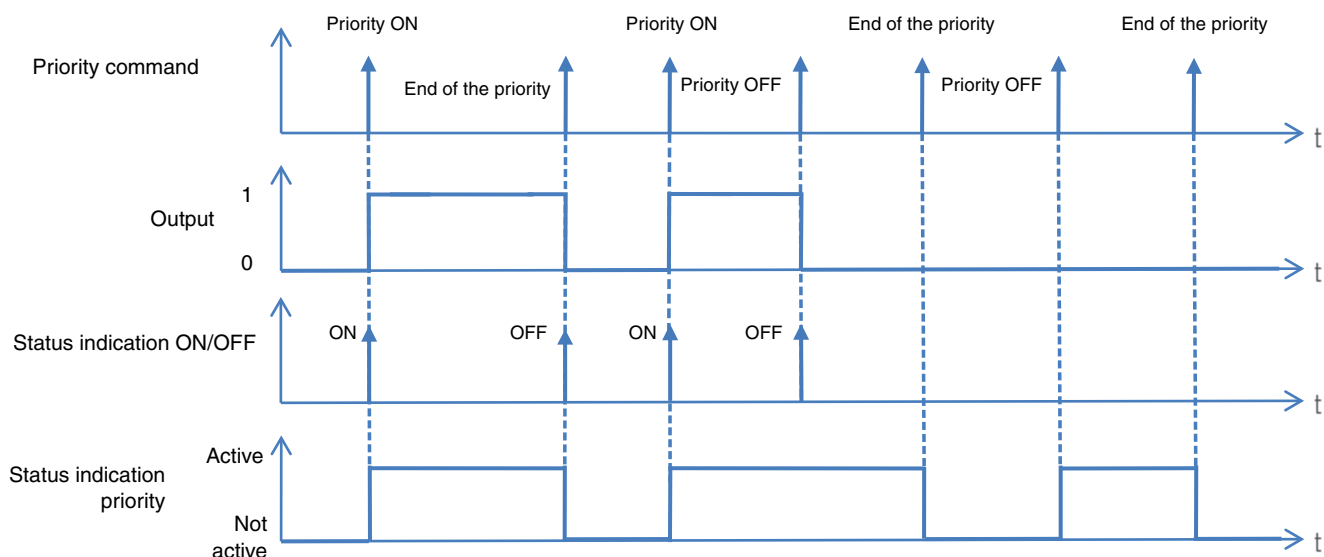

Communication objects: **3 - Output - Priority** (2 Bit – 2.002 DPT_Bool_Control)
4 - Output - Status indication priority (1 Bit – 1.011 DPT_State)

Communication objects: **12 - Output - Priority** (2 Bit – 2.002 DPT_Bool_Control)
13 - Output - Status indication priority (1 Bit – 1.011 DPT_State)

3.1.2.3 Automatic control

The Automatic control function is used to command an output in parallel to the ON/OFF function. The two functions have the same level of priority. The last command received will act on the status of the output. An additional command object is used to activate or deactivate the Automatic control.

Example: when an output is controlled by a button and in parallel by an automatic control (timer, twilight switch, weather station, etc.) the automatic control can be deactivated for reasons of comfort (vacations, public holidays, etc.).



Operating principle:

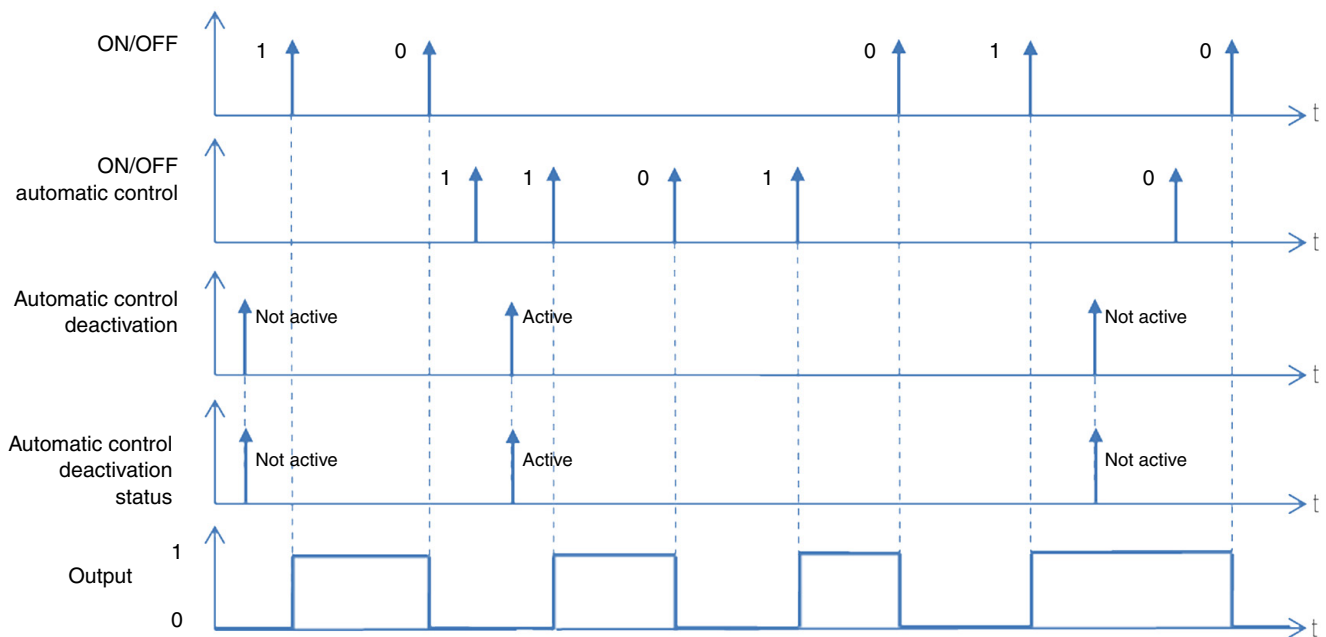

- Communication objects:
- 6 - Output - ON/OFF automatic control (1 Bit – 1.001 DPT_Switch)**
 - 7 - Output - Automatic control deactivation (1 Bit – 1.003 DPT_Enable)**
 - 8 - Output - Automatic control deactivation status (1 Bit – 1.003 DPT_Enable)**
 - 4 - Output - ON/OFF automatic control (1 Bit – 1.001 DPT_Switch)**
 - 6 - Output - Automatic control deactivation (1 Bit – 1.003 DPT_Enable)**
 - 7 - Output - Automatic control deactivation status (1 Bit – 1.003 DPT_Enable)**

3.1.2.4 Load shedding

The Load shedding function is used to force an output to OFF. Load shedding is activated by receipt of a 1-byte command. Priority: **Load shedding** > Priority > Basic function.

This command has the highest priority. No other command is taken into account if the mode is active. The status of the output is memorised but not applied. At the end of load shedding, the output is switched to the theoretical status without Load shedding (memorisation).

Note: The Load shedding function is only available in products TRM693G and TRM694G.

Example: Load shedding function

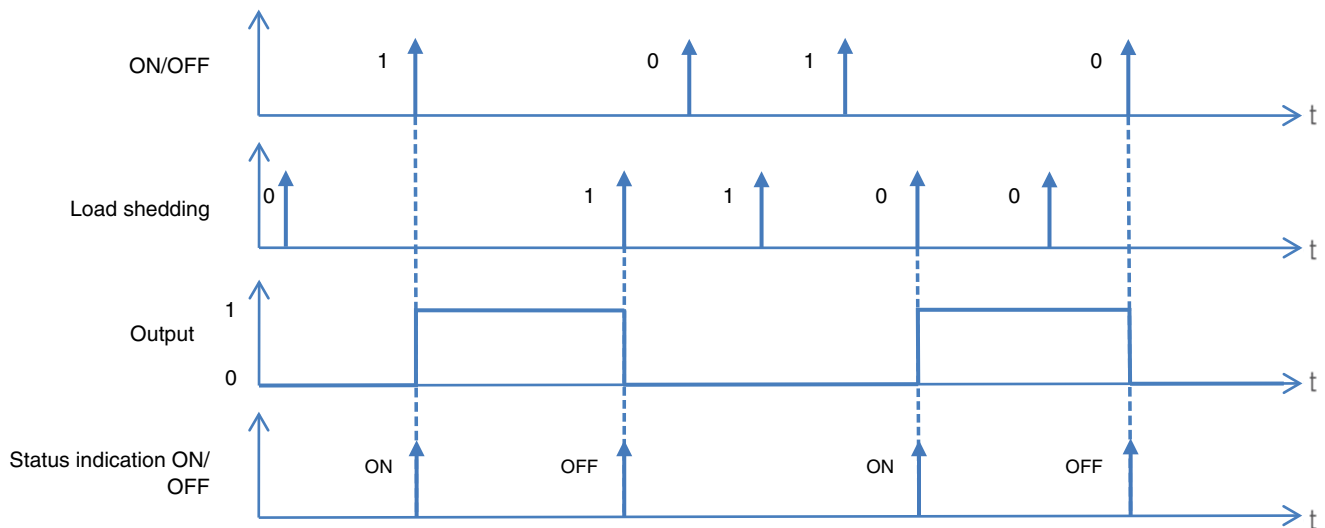

Communication objects: **9 - Output - Load shedding (1 Bit – 1.001 DPT_Switch)**

3.1.2.5 Scene

Scene	<input checked="" type="checkbox"/>
Number of scenes used	8
Scene 1	<input checked="" type="checkbox"/>
Output status for scene 1	<input type="radio"/> OFF <input checked="" type="radio"/> ON
Scene 2	<input type="checkbox"/>
Scene 3	<input type="checkbox"/>
Scene 4	<input type="checkbox"/>
Scene 5	<input type="checkbox"/>
Scene 6	<input type="checkbox"/>
Scene 7	<input type="checkbox"/>
Scene 8	<input type="checkbox"/>

Parameter	Description	Value
Number of scenes used	This parameter determines the number of scenes used.	8* - 16 - 32 - 48 - 64

Note: If the Scene number received on the Scene object is greater than the maximum number of scenes, the status of the output remains unchanged.

Parameter	Description
Scene x	This parameter is used to activate the scene in question.

Parameter	Description	Value
Output status for scene x	On activation of Scene x, the output is: Selectively switched on. Selectively switched off.	ON* OFF

x = 1 to 64

*Note: Each output has up to 64 scenes available, in accordance with the **Number of scenes used** parameter.*

Communication objects: [5 - Output - Scene \(1 Byte – 18.001 DPT_SceneControl\)](#)
 [11 - Output - Scene \(1 Byte – 18.001 DPT_SceneControl\)](#)

* Default value

Operating principle:

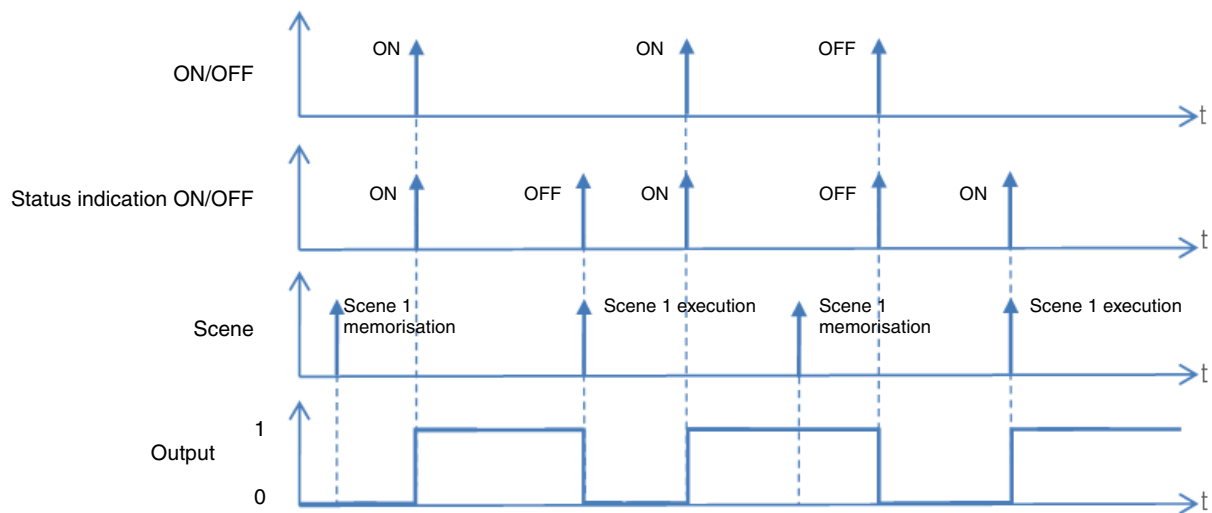

Learning and storing scenes

This process is used to change and store a scene. For example, by locally pressing the key in the room or by emission of the values from a visualization.

To access and store scenes, the following values must be sent:

Scene number	Access scene (Object value: 1 byte)	Store scene (Object value: 1 byte)
1-64	= Scene number - 1	= Scene number + 128
Examples		
1	0	128
2	1	129
3	2	130
...	...	
64	63	191

Here is the scene memorisation for local switches, for example.

- Activate scene by briefly pressing the transmitter that starts it.
- The outputs (lights, shutters, etc.) are set in the desired state using the usual local control devices (buttons, remote control, etc.).
- Memorise the status of the outputs with a press greater than 5 seconds long on the transmitter that starts the scene. The memorisation can be displayed by short-term activation of the outputs.

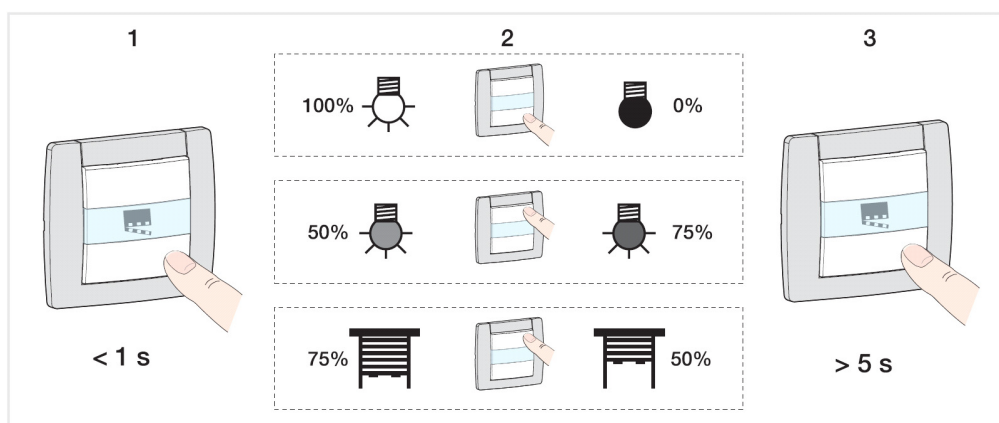

3.1.3 Input operation mode

This configuration enables the input operating mode to be defined. These parameters are available for each input individually.

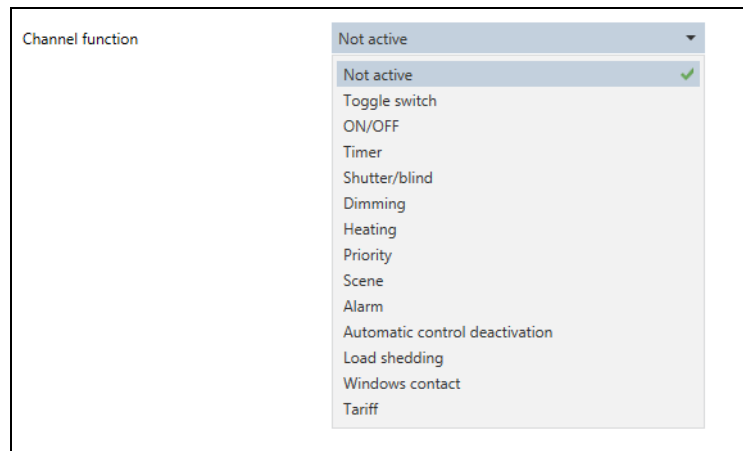

The input default value is not active.

The following parameters are available:

- Toggle switch
- ON/OFF
- Timer
- Shutter/blind
- Dimming
- Heating
- Priority
- Scene
- Alarm
- Automatic control deactivation
- Load shedding
- Windows contact
- Tariff

3.1.3.1 Toggle switch

This function enables a lighting circuit or any other load to be commanded to switch on or off. Each time the push-button is pressed the output status is inverted.

Description: After a press on the push-button, according to the object **Indication of ON/OFF status** an ON or OFF command will be issued to the bus via the object **ON/OFF**..

Operating principle:

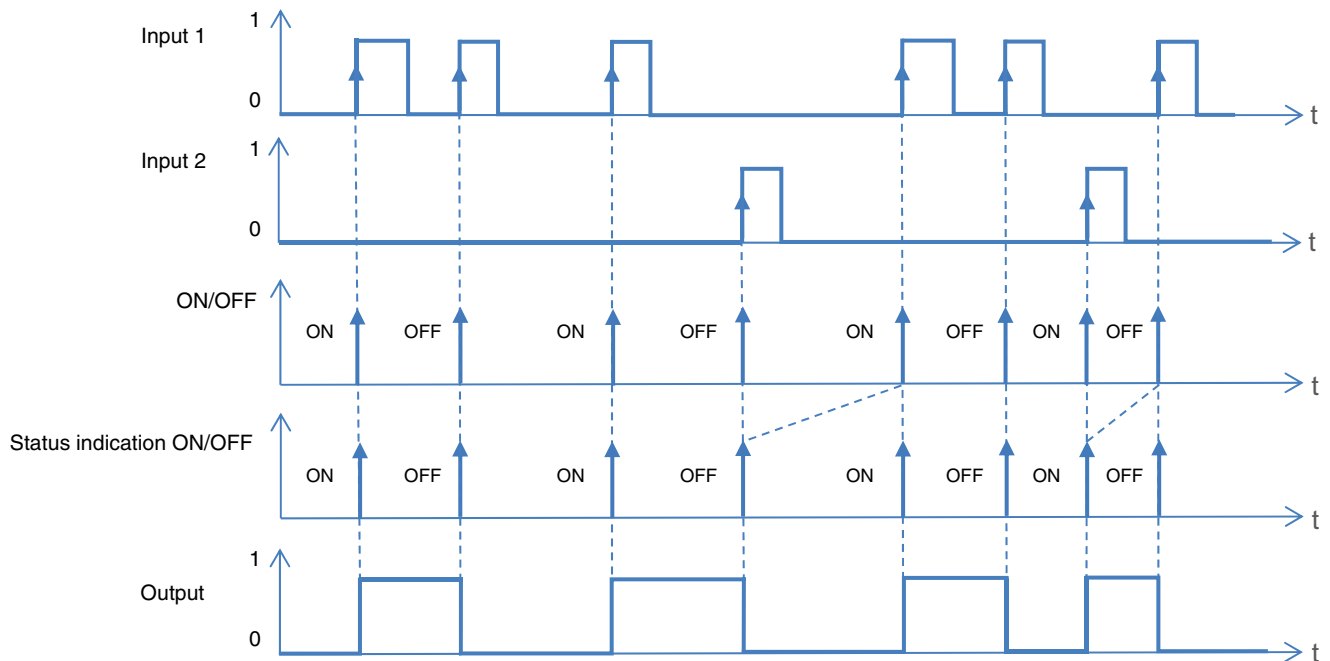

- Communication objects:
- 10 - Input 1 - Status indication ON/OFF** (1 Bit – 1.001 DPT_Switch)
 - 11 - Input 1 - ON/OFF** (1 Bit – 1.001 DPT_Switch)
 - 20 - Input 2 - Status indication ON/OFF** (1 Bit – 1.001 DPT_Switch)
 - 21 - Input 2 - ON/OFF** (1 Bit – 1.001 DPT_Switch)

- Communication objects:
- 14 - Input 1 - Status indication ON/OFF** (1 Bit – 1.001 DPT_Switch)
 - 15 - Input 1 - ON/OFF** (1 Bit – 1.001 DPT_Switch)
 - 24 - Input 2 - Status indication ON/OFF** (1 Bit – 1.001 DPT_Switch)
 - 25 - Input 2 - ON/OFF** (1 Bit – 1.001 DPT_Switch)

3.1.3.2 ON/OFF

An output can be switched on or off using the ON/OFF function. The command can come from switches, push-buttons or automations.

Channel function	ON/OFF
Using mode	ON/OFF
Inverted	<input type="checkbox"/>

Parameter	Description	Value
Using mode	This parameter defines the commands issued at changes of the input status.	ON/-, OFF/-, ON/OFF* , OFF/ON, -/ON, -/OFF

*Note: By default, the input operates like an NO contact (Normally open). If the parameter **Inverted** is validated, the input operates like an NC contact (Normally closed).*

The operation of the input contact may be configured according to whether the contact is open or closed (ON, OFF).

6 different combinations are available:

Function by press	Function on release
ON	-
OFF	-
ON	OFF
OFF	ON
-	ON
-	OFF

Communication objects: **11 - Input 1 - ON/OFF** (1 Bit – 1.001 DPT_Switch)
21 - Input 2 - ON/OFF (1 Bit – 1.001 DPT_Switch)

Communication objects: **15 - Input 1 - ON/OFF** (1 Bit – 1.001 DPT_Switch)
25 - Input 2 - ON/OFF (1 Bit – 1.001 DPT_Switch)

* Default value

3.1.3.3 Timer

The Timer function enables a lighting, rolling shutter or heating circuit to be switched on or off for a programmable length of time. A short press on the push-button re-launches the timer. The timer can be interrupted before the end of the time by a long press.

Operating principle:

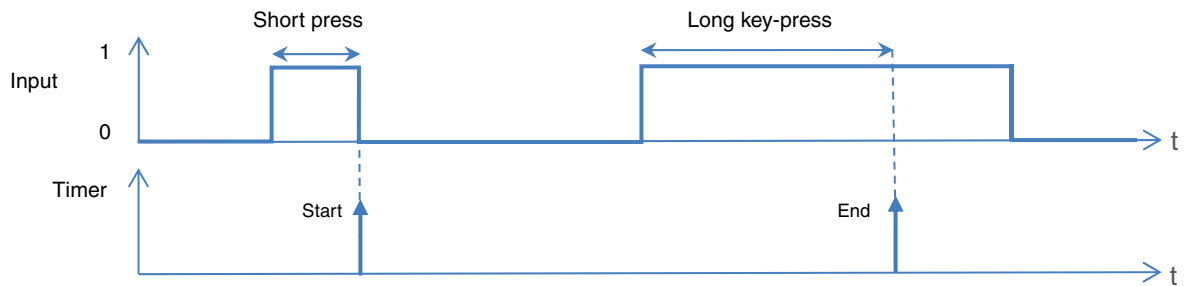

Communication objects: **11 - Input 1 - Timer** (1 Bit – 1.001 DPT_Switch)

21 - Input 2 - Timer (1 Bit – 1.001 DPT_Switch)

Communication objects: **15 - Input 1 - Timer** (1 Bit – 1.001 DPT_Switch)

25 - Input 2 - Timer (1 Bit – 1.001 DPT_Switch)

3.1.3.4 Shutter and blind

This function enables a rolling shutter or a blind to be controlled from 2 push-buttons. The Up/Down command (**Up/Down** object) is issued by a long press on the button. The Stop/Tilt function issues the object **Tilt/Stop** (short press).

Channel function	Shutter/blind
Closing type	<input checked="" type="radio"/> Shutter <input type="radio"/> Shutter and blind
Shutter function	2-button shutter
Function by press	<input checked="" type="radio"/> Up <input type="radio"/> Down

Parameter	Description	Value
Closing type	This parameter defines the operating mode used for the affected outputs. An operating mode of the shutter and blind type gives access to additional parameters to control the slat pitch.	Shutter* Shutter and blind

■ Shutter

Parameter	Description	Value
Shutter function	The shutter command works: Using the input contact programmed to up or down Using the input contact programmed to up or down. According to whether the input contact is open or closed. According to a position value in % on pressing and releasing the input contact.	1-button shutter 2-button shutter* Switch for shutter control Position (0-100%)

- 2-button shutter

Parameter	Description	Value
Function by press	On shutting the input contact, the order issued is: Opening the rolling shutter. Closing the rolling shutter.	Up* Down

*Note: This parameter is only visible when the parameter **Shutter function** has the value: **2-button shutter**.*

- Switch for shutter control

Parameter	Description	Value
Using mode	This parameter defines the commands issued at changes of the input status.	Up/- Down/- Up/down* Down/Up -/Up -/Down Up/stop Stop/up

*Note: This parameter is only visible when the parameter **Shutter function** has the value: **Switch for shutter control**.*

The operation of the input contact may be configured according to whether the contact is open or closed (Up, Down).

* Default value

6 different combinations are available:

Function by press	Function on release
Up	-
Down	-
Up	Down
Down	Up
-	Up
-	Down
Up	Stop
Stop	Up

Note: By default, the input operates like an NO contact (Normally open). If the parameter **Inverted** is validated, the input operates like an NC contact (Normally closed).

Communication objects:

- 11 - Input 1 - Up/down (1 Bit – 1.008 DPT_UpDown)
- 12 - Input 1 - Stop (short press) (1 Bit – 1.017 DPT_Trigger)
- 21 - Input 2 - Up/down (1 Bit – 1.008 DPT_UpDown)
- 22 - Input 2 - Stop (short press) (1 Bit – 1.017 DPT_Trigger)

Communication objects:

- 15 - Input 1 - Up/down (1 Bit – 1.008 DPT_UpDown)
- 16 - Input 1 - Stop (short press) (1 Bit – 1.017 DPT_Trigger)
- 25 - Input 2 - Up/down (1 Bit – 1.008 DPT_UpDown)
- 26 - Input 2 - Stop (short press) (1 Bit – 1.017 DPT_Trigger)

- Position (0-100%)

This function enables the object **Position in %** to be issued according to 2 types of event. These 2 events correspond to the open or closed status of the input contact. Additional parameters define the positions for the 2 events.

Parameter	Description	Value
Using mode	The shutter command operates according to a position value in %: On pressing and releasing the input contact. On only pressing the input contact. On only releasing the input contact.	Function by press/ release* Function by press Function on release

Note: This parameter is only visible when the parameter **Shutter function** has the value: **Position (0-100%)**.

Parameter	Description	Value
Position by press (0-100%)	This parameter defines the position of the rolling shutter to apply during the press.	0...100*

Note: This parameter is only visible when the parameter **Shutter function** has the value: **Position (0-100%)**.

* Default value

Parameter	Description	Value
Position on release (0-100%)	This parameter defines the position of the rolling shutter to apply at release.	0*...100

Note: This parameter is only visible when the parameter **Shutter function** has the value: **Position (0-100%)**.

Note: By default, the input operates like an NO contact (Normally open). If the parameter **Inverted** is validated, the input operates like an NC contact (Normally closed).

Communication objects: [15 - Input 1 - Position in % \(1 Byte – 5.001 DPT_Scaling\)](#)
[25 - Input 2 - Position in % \(1 Byte – 5.001 DPT_Scaling\)](#)

Communication objects: [19 - Input 1 - Position in % \(1 Byte – 5.001 DPT_Scaling\)](#)
[29 - Input 2 - Position in % \(1 Byte – 5.001 DPT_Scaling\)](#)

■ Shutter and blind

Parameter	Description	Value
Blind function	The shutter/blind command operates: Using the input contact programmed to up or down. According to the slat angle value in % on pressing and releasing the input contact. According to a position value in % and a slat angle in % on pressing and releasing the input contact.	Up/down/step/stop* Slat angle (0-100%) Position/Slat angle (0-100%)

- Up/down/step/stop

Parameter	Description	Value
Function by press	On shutting the input contact, the order issued is: Shutter or blind open. Shutter or blind closed.	Up* Down

Note: This parameter is only visible when the parameter **Blind function** has the value: **Up/down/step/stop**.

Communication objects: [11 - Input 1 - Up/down \(1 Bit – 1.008 DPT_UpDown\)](#)
[12 - Input 1 - Step/stop \(short press\) \(1 Bit – 1.007 DPT_Step\)](#)
[21 - Input 2 - Up/down \(1 Bit – 1.008 DPT_UpDown\)](#)
[22 - Input 2 - Step/stop \(short press\) \(1 Bit – 1.007 DPT_Step\)](#)

Communication objects: [15 - Input 1 - Up/down \(1 Bit – 1.008 DPT_UpDown\)](#)
[16 - Input 1 - Step/stop \(short press\) \(1 Bit – 1.007 DPT_Step\)](#)
[25 - Input 2 - Up/down \(1 Bit – 1.008 DPT_UpDown\)](#)
[26 - Input 2 - Step/stop \(short press\) \(1 Bit – 1.007 DPT_Step\)](#)

* Default value

- Position/Slat angle (0-100%)

This function enables the objects **Position in %** and **Slat angle in %** to be issued according to 2 types of event. These 2 events correspond to the open or closed status of the input contact. Additional parameters define the positions for the 2 events.

Parameter	Description	Value
Using mode	The shutter/blind command operates according to a position value in % and a slat angle in %: On pressing and releasing the input contact. On only pressing the input contact. On only releasing the input contact.	Function by press/ release* Function by press Function on release

*Note: This parameter is only visible when the parameter **Blind function** has the value: **Slat angle (0-100%)** or **Position/Slat angle (0-100%)**.*

Parameter	Description	Value
Slat angle by press (0-100%)	This parameter defines the slat position to apply during the press.	0...100*

*Note: This parameter is only visible when the parameter **Blind function** has the value: **Slat angle (0-100%)** or **Position/Slat angle (0-100%)**.*

Parameter	Description	Value
Slat angle on release (0-100%)	This parameter defines the slat position to apply at release.	0*...100

*Note: This parameter is only visible when the parameter **Blind function** has the value: **Slat angle (0-100%)** or **Position/Slat angle (0-100%)**.*

*Note: By default, the input operates like an NO contact (Normally open). If the parameter **Inverted** is validated, the input operates like an NC contact (Normally closed).*

Parameter	Description	Value
Position by press (0-100%)	This parameter defines the blind position to apply during the press.	0...100*

*Note: This parameter is only visible when the parameter **Blind function** has the value: **Position/Slat angle (0-100%)**.*

Parameter	Description	Value
Position on release (0-100%)	This parameter defines the blind position to apply at release.	0*...100

*Note: This parameter is only visible when the parameter **Blind function** has the value: **Position/Slat angle (0-100%)**.*

*Note: By default, the input operates like an NO contact (Normally open). If the parameter **Inverted** is validated, the input operates like an NC contact (Normally closed).*

* Default value

Communication objects:

- 15 - Input 1 - Position in %** (1 Byte – 5.001 DPT_Scaling)
- 16 - Input 1 - Slat angle in %** (1 Byte – 5.001 DPT_Scaling)
- 25 - Input 2 - Position in %** (1 Byte – 5.001 DPT_Scaling)
- 26 - Input 2 - Slat angle in %** (1 Byte – 5.001 DPT_Scaling)

Communication objects:

- 19 - Input 1 - Position in %** (1 Byte – 5.001 DPT_Scaling)
- 20 - Input 1 - Slat angle in %** (1 Byte – 5.001 DPT_Scaling)
- 29 - Input 2 - Position in %** (1 Byte – 5.001 DPT_Scaling)
- 30 - Input 2 - Slat angle in %** (1 Byte – 5.001 DPT_Scaling)

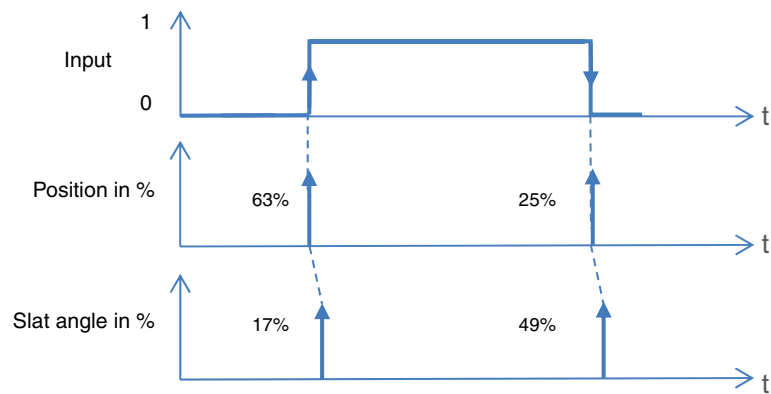

*Note: The value of the object **Position in %** is issued before the object value **Slat angle in %** so that the output module can position the blind before tilting it.*

3.1.3.5 Dimming

Channel function	Dimming
Dimming function	Increase/decrease
Function by press	<input checked="" type="radio"/> Increase <input type="radio"/> Decrease

Parameter	Description	Value
Dimming function	<p>The dimming command operates:</p> <p>Using the input contact configured to increase or decrease (Dimming command on 2 buttons).</p> <p>Using the input contact configured to increase or decrease (Dimming command on 1 button).</p> <p>According to a brightness value in % on pressing and releasing the input contact.</p>	<p>Increase/decrease*</p> <p>Increase/decrease Toggle switch</p> <p>Brightness value</p>

- Increase/decrease Toggle switch

This function enables the objects **ON/OFF**, **Dimming** and **ON/OFF status indication** to be issued according to 2 types of event. These 2 events correspond to a short press enabling the ON/OFF command or long press enabling the dimming command.

This function corresponds to the dimming command on 1 button.

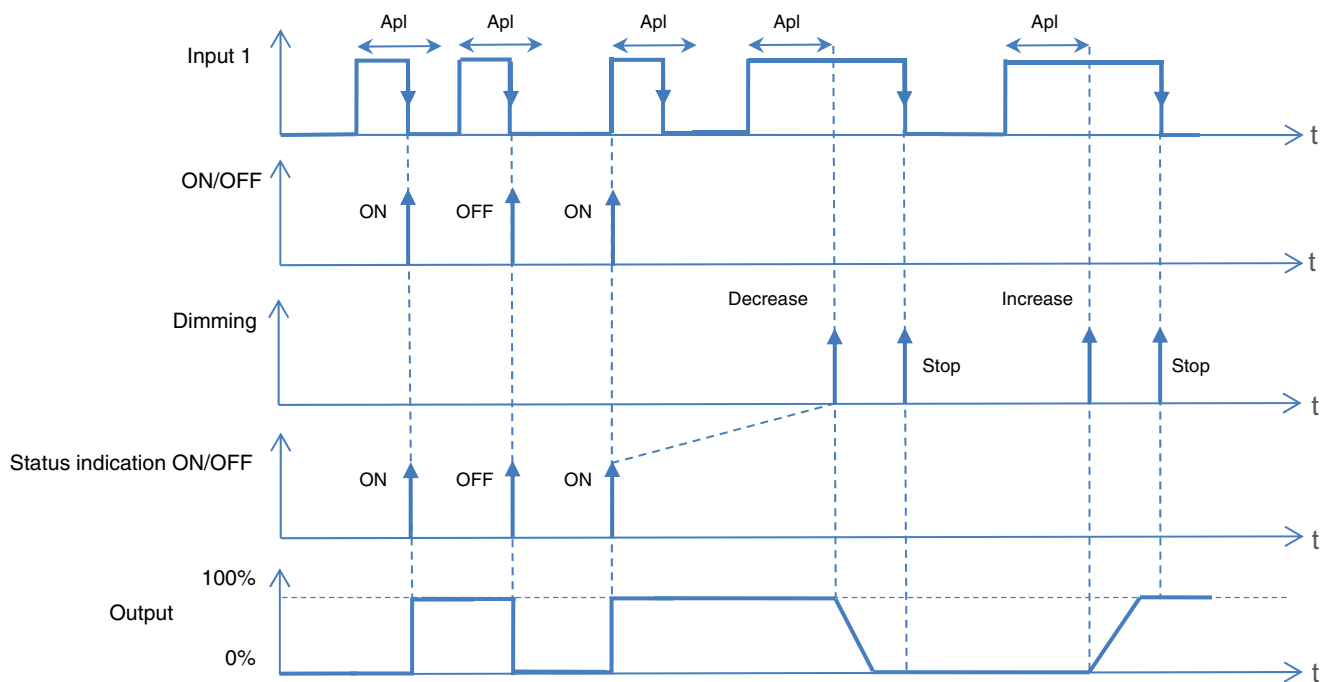

Apl: Long key-press

* Default value

Communication objects:

- [10 - Input 1 - Status indication ON/OFF](#) (1 Bit – 1.001 DPT_Switch)
- [11 - Input 1 - ON/OFF](#) (1 Bit – 1.001 DPT_Switch)
- [14 - Input 1 - Dimming](#) (4 Bits – 3.007 DPT_Control_Dimming)
- [20 - Input 2 - Status indication ON/OFF](#) (1 Bit – 1.001 DPT_Switch)
- [21 - Input 2 - ON/OFF](#) (1 Bit – 1.001 DPT_Switch)
- [24 - Input 2 - Dimming](#) (4 Bits – 3.007 DPT_Control_Dimming)

Communication objects:

- [14 - Input 1 - Status indication ON/OFF](#) (1 Bit – 1.001 DPT_Switch)
- [15 - Input 1 - ON/OFF](#) (1 Bit – 1.001 DPT_Switch)
- [18 - Input 1 - Dimming](#) (4 Bits – 3.007 DPT_Control_Dimming)
- [24 - Input 2 - Status indication ON/OFF](#) (1 Bit – 1.001 DPT_Switch)
- [25 - Input 2 - ON/OFF](#) (1 Bit – 1.001 DPT_Switch)
- [28 - Input 2 - Dimming](#) (4 Bits – 3.007 DPT_Control_Dimming)

- Increase/decrease

This function enables the objects **ON/OFF** and **Dimming** to be issued according to 2 types of events. These 2 events correspond to a short press enabling the ON/OFF command or long press enabling the dimming command. Additional parameters defined the dimming direction.

This function corresponds to the dimming command on 2 buttons.

Parameter	Description	Value
Function by press	This parameter defines the dimming direction corresponding to the input.	Increase* Decrease

*Note: This parameter is only visible when the parameter **Dimming function** has the value: **Increase/decrease**.*

Communication objects:

- [11 - Input 1 - ON/OFF](#) (1 Bit – 1.001 DPT_Switch)
- [14 - Input 1 - Dimming](#) (4 Bits – 3.007 DPT_Control_Dimming)
- [21 - Input 2 - ON/OFF](#) (1 Bit – 1.001 DPT_Switch)
- [24 - Input 2 - Dimming](#) (4 Bits – 3.007 DPT_Control_Dimming)

Communication objects:

- [15 - Input 1 - ON/OFF](#) (1 Bit – 1.001 DPT_Switch)
- [18 - Input 1 - Dimming](#) (4 Bits – 3.007 DPT_Control_Dimming)
- [25 - Input 2 - ON/OFF](#) (1 Bit – 1.001 DPT_Switch)
- [28 - Input 2 - Dimming](#) (4 Bits – 3.007 DPT_Control_Dimming)

* Default value

Example: Input 1: Increase
 Input 2: Decrease

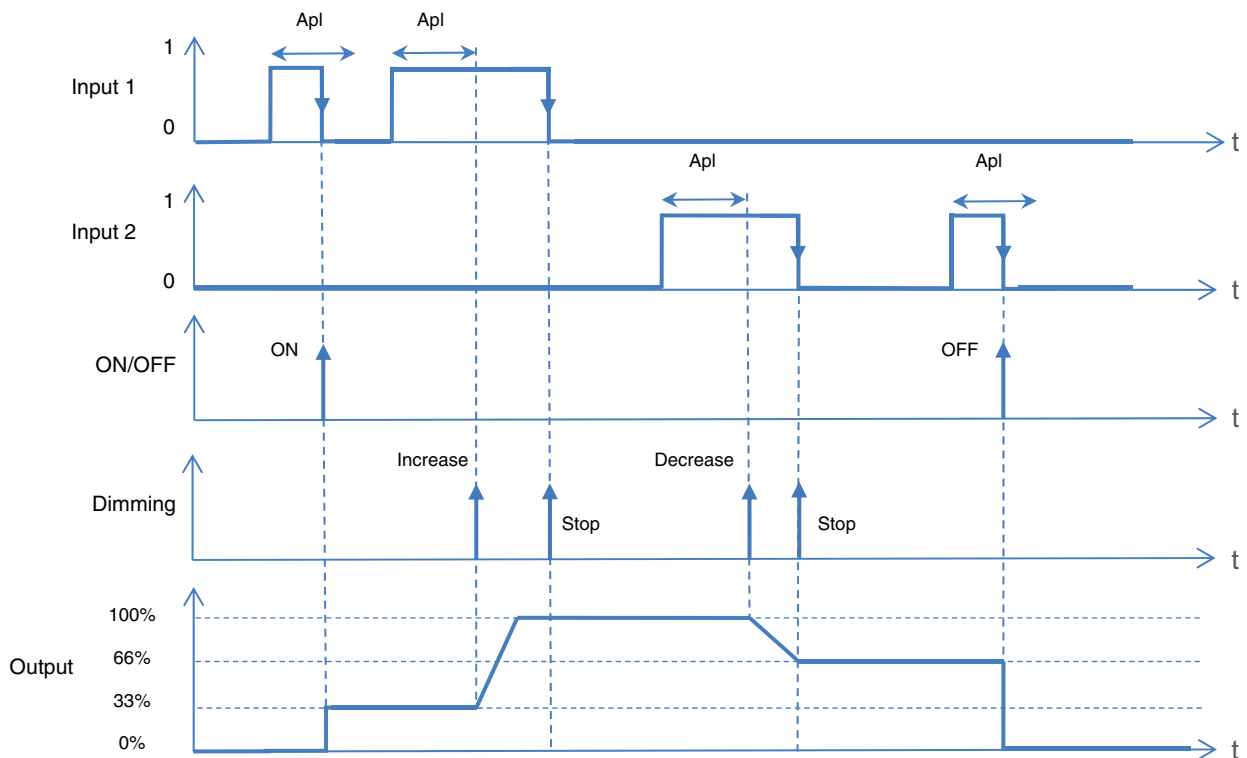

Apl: Long key-press

- Brightness value

Parameter	Description	Value
Using mode	The dimming command operates according to a brightness value in %: On pressing and releasing the input contact. On only pressing the input contact. On only releasing the input contact.	Function by press/ release* Function by press Function on release

Note: This parameter is only visible when the parameter **Dimming function** has the value: **Brightness value**.

Parameter	Description	Value
Brightness value by press	This parameter defines the brightness value to apply during the press.	0...100*

Note: This parameter is only visible when the parameter **Dimming function** has the value: **Brightness value**.

* Default value

Parameter	Description	Value
Brightness value at release	This parameter defines the brightness value to apply at release.	0*...100

Note: This parameter is only visible when the parameter **Dimming function** has the value: **Brightness value**.

Note: By default, the input operates like an NO contact (Normally open). If the parameter **Inverted** is validated, the input operates like an NC contact (Normally closed).

Communication objects: **15 - Input 1 - Brightness value** (1 Byte – 5.001 DPT_Scaling)

25 - Input 2 - Brightness value (1 Byte – 5.001 DPT_Scaling)

Communication objects: **19 - Input 1 - Brightness value** (1 Byte – 5.001 DPT_Scaling)

29 - Input 2 - Brightness value (1 Byte – 5.001 DPT_Scaling)

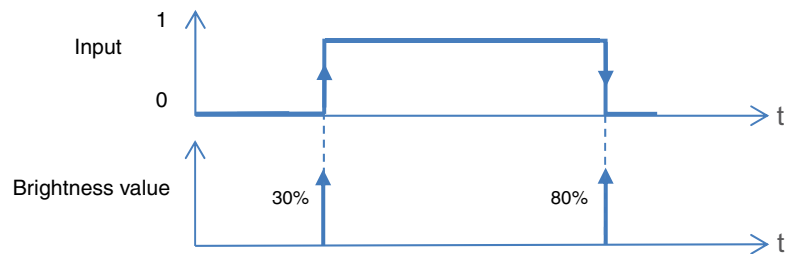

* Default value

3.1.3.6 Heating

Channel function	Heating
Heating function	<input type="radio"/> Heating/Cooling <input checked="" type="radio"/> Setpoint selection
Using mode	Function by press/release
Setpoint by press	Comfort
Setpoint on release	Night setpoint
Inverted	<input type="checkbox"/>

Parameter	Description	Value
Heating function	The heating command operates: According to a heating instruction on pressing and releasing the input contact. Using the input contact configured in heating or cooling mode.	Setpoint selection* Heating/Cooling

- Heating/Cooling

This function enables the object (Heating/cooling-changeover) to be issued on the KNX bus.

Communication objects:

11 - Input 1 - Heating/Cooling - changeover (1 Bit – 1.100 DPT_Cooling/heating)

21 - Input 2 - Heating/Cooling - changeover (1 Bit – 1.100 DPT_Cooling/heating)

15 - Input 1 - Heating/Cooling - changeover (1 Bit – 1.100 DPT_Cooling/heating)

25 - Input 2 - Heating/Cooling - changeover (1 Bit – 1.100 DPT_Cooling/heating)

*Note: By default, the input operates like an NO contact (Normally open). If the parameter **Inverted** is validated, the input operates like an NC contact (Normally closed).*

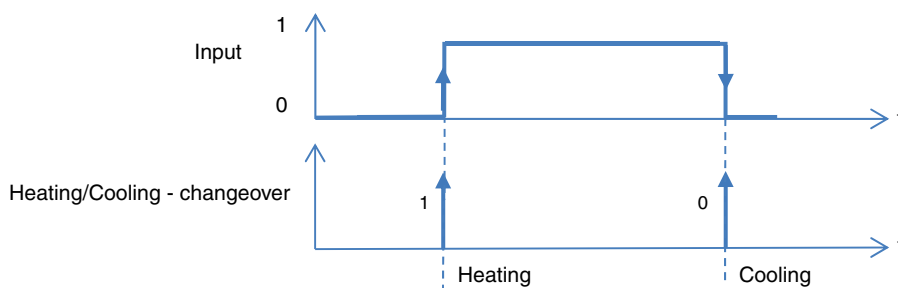

- Setpoint selection

This function enables the object **Instruction selection** to be issued according to 2 types of event. These 2 events correspond to the open or closed status of the input contact. Extra parameters define the heating instructions for 2 events.

* Default value

Parameter	Description	Value
Using mode	The heating command operates according to a heating instruction: On pressing and releasing the input contact. On only pressing the input contact. On only releasing the input contact.	Function by press/release* Function by press Function on release

Note: This parameter is only visible when the parameter **Heating function** has the value: **Setpoint selection**.

Parameter	Description	Value
Setpoint by press	This parameter defines the heating instruction to apply during the press.	Auto Comfort* Standby Night setpoint Frost protection

Parameter	Description	Value
Threshold at release	This parameter defines the heating instruction to apply at release.	Auto Comfort Standby Night setpoint* Frost protection

Note: By default, the input operates like an NO contact (Normally open). If the parameter **Inverted** is validated, the input operates like an NC contact (Normally closed).

Communication objects:

15 - Input 1 - Setpoint selection (1 Byte – 20.102 DPT_HVAC mode)

25 - Input 2 - Setpoint selection (1 Byte – 20.102 DPT_HVAC mode)

19 - Input 1 - Setpoint selection (1 Byte – 20.102 DPT_HVAC mode)

29 - Input 2 - Setpoint selection (1 Byte – 20.102 DPT_HVAC mode)

* Default value

3.1.3.7 Priority

Channel function	Priority
Using mode	<input checked="" type="radio"/> Priority ON/down/comfort <input type="radio"/> Priority OFF/up/frost protection
Inverted	<input type="checkbox"/>

The Priority function is used to force the output into a defined state.

The priority action depends on the type of application commanded: Lighting ON/OFF, Rolling shutter, Heating.

This function the priority or priority cancellation controls to be issued.

No other command is taken into account when the Priority is active. Only priority or alarm cancellation commands will be taken into account.

Parameter	Description	Value
Using mode	This parameter defines the priority type to apply during the press.	Priority ON/down/comfort* Priority OFF/up/frost protection

*Note: By default, the input operates like an NO contact (Normally open). If the parameter **Inverted** is validated, the input operates like an NC contact (Normally closed).*

Communication objects: [13 - Input 1 - Priority \(2 Bit – 2.002 DPT_Bool_Control\)](#)

[23 - Input 2 - Priority \(2 Bit – 2.002 DPT_Bool_Control\)](#)

Communication objects: [17 - Input 1 - Priority \(2 Bit – 2.002 DPT_Bool_Control\)](#)

[27 - Input 2 - Priority \(2 Bit – 2.002 DPT_Bool_Control\)](#)

* Default value

3.1.3.8 Scene

This function enables scenes to be saved or selected. These concern different types of output (lighting, blind, shutter, heating) to create ambiances or scenarios (leaving scenario, reading ambiance etc.).

Channel function	Scene
Scene function	<input type="radio"/> Switch for scene <input checked="" type="radio"/> Scene 1-64
Scene number (1-64) by press	1

Parameter	Description	Value
Scene function	The scene command operates: According to a scene number on pressing the input contact. According to a scene number on pressing and releasing the input contact.	Scene 1-64* Switch for scene

- Scene 1-64

Parameter	Description	Value
Scene number (1-64) by press	This parameter defines the scene number to apply during the press.	1*...64

*Note: This parameter is only visible when the parameter **Scene function** has the value: **Scene 1-64**.*

Communication objects: [15 - Input 1 - Scene](#) (1 Byte – 18.001 DPT_SceneControl)
[25 - Input 2 - Scene](#) (1 Byte – 18.001 DPT_SceneControl)

Communication objects: [19 - Input 1 - Scene](#) (1 Byte – 18.001 DPT_SceneControl)
[29 - Input 2 - Scene](#) (1 Byte – 18.001 DPT_SceneControl)

- Switch for scene

Parameter	Description	Value
Using mode	The scene number is sent On pressing and releasing the input contact. On only pressing the input contact. On only releasing the input contact.	Function by press/ release* Function by press Function on release

*Note: This parameter is only visible when the parameter **Scene function** has the value: **Switch for scene**.*

Parameter	Description	Value
Scene number (1-64) by press	This parameter defines the scene number to apply during the press.	1*...64

* Default value

Parameter	Description	Value
Scene number (1-64) on release	This parameter defines the scene number to apply at release.	1... 2 ...64

*Note: By default, the input operates like an NO contact (Normally open). If the parameter **Inverted** is validated, the input operates like an NC contact (Normally closed).*

Communication objects: **15 - Input 1 - Scene** (1 Byte – 18.001 DPT_SceneControl)

25 - Input 2 - Scene (1 Byte – 18.001 DPT_SceneControl)

Communication objects: **19 - Input 1 - Scene** (1 Byte – 18.001 DPT_SceneControl)

29 - Input 2 - Scene (1 Byte – 18.001 DPT_SceneControl)

* Default value

3.1.3.9 Alarm

The Alarm function issues alarms on a cyclical basis to the bus from automations (anemometer, rain detector, twilight switch etc.). The cycle time is set to 10 minutes.

Channel function	Alarm
Alarm type	Alarm 1
Inverted	<input type="checkbox"/>

Parameter	Description	Value
Alarm type	This parameter defines the type of alarm to be issued on the KNX bus.	Alarm 1* Alarm 2 Alarm 3

- Communication objects:
- 11 - Input 1 - Alarm 1 (1 Bit – 1.005 DPT_Alarm)
 - 21 - Input 2 - Alarm 1 (1 Bit – 1.005 DPT_Alarm)
 - 11 - Input 1 - Alarm 2 (1 Bit – 1.005 DPT_Alarm)
 - 21 - Input 2 - Alarm 2 (1 Bit – 1.005 DPT_Alarm)
 - 11 - Input 1 - Alarm 3 (1 Bit – 1.005 DPT_Alarm)
 - 21 - Input 2 - Alarm 3 (1 Bit – 1.005 DPT_Alarm)

- Communication objects:
- 15 - Input 1 - Alarm 1 (1 Bit – 1.005 DPT_Alarm)
 - 25 - Input 2 - Alarm 1 (1 Bit – 1.005 DPT_Alarm)
 - 15 - Input 1 - Alarm 2 (1 Bit – 1.005 DPT_Alarm)
 - 25 - Input 2 - Alarm 2 (1 Bit – 1.005 DPT_Alarm)
 - 15 - Input 1 - Alarm 3 (1 Bit – 1.005 DPT_Alarm)
 - 25 - Input 2 - Alarm 3 (1 Bit – 1.005 DPT_Alarm)

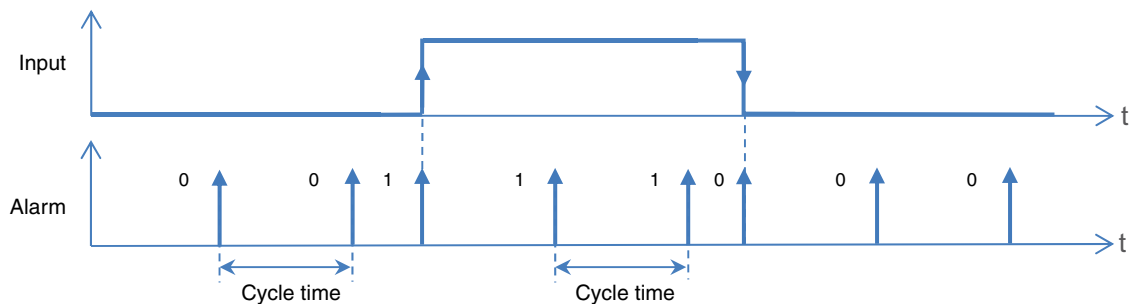

* Default value

3.1.3.10 Automatic control deactivation

The Automatic control function enables an output to be controlled in parallel to the standard control. An additional command object (Automatic control deactivation) is used to activate or deactivate Automatic control.

*Note: By default, the input operates like an NO contact (Normally open). If the parameter **Inverted** is validated, the input operates like an NC contact (Normally closed).*

Communication objects: **11 - Input 1 - Automatic control deactivation** (1 Bit – 1.003 DPT_Enable)
 21 - Input 2 - Automatic control deactivation (1 Bit – 1.003 DPT_Enable)

Communication objects: **15 - Input 1 - Automatic control deactivation** (1 Bit – 1.003 DPT_Enable)
 25 - Input 2 - Automatic control deactivation (1 Bit – 1.003 DPT_Enable)

3.1.3.11 Load shedding

The Load shedding function is used to force an output to OFF. Load shedding is activated by receipt of a 1-byte command. At the end of load shedding, the output is switched to the theoretical status without Load shedding (memorisation).

*Note: By default, the input operates like an NO contact (Normally open). If the parameter **Inverted** is validated, the input operates like an NC contact (Normally closed).*

Communication objects: **11 - Input 1 - Load shedding** (1 Bit – 1.002 DPT_Bool)
 21 - Input 2 - Load shedding (1 Bit – 1.002 DPT_Bool)

Communication objects: **15 - Input 1 - Load shedding** (1 Bit – 1.002 DPT_Bool)
 25 - Input 2 - Load shedding (1 Bit – 1.002 DPT_Bool)

3.1.3.12 Windows contact

The Window contact function enables the window opening/closing information to be sent to the KNX bus.

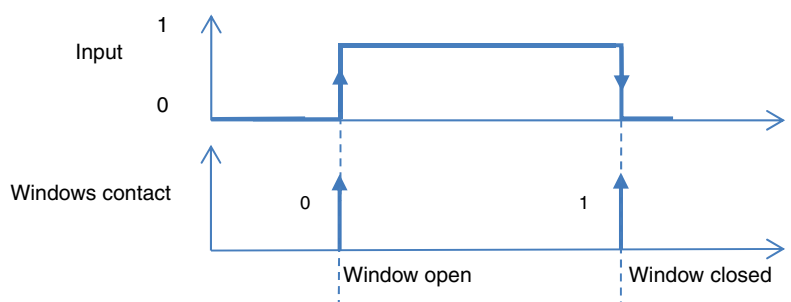

*Note: By default, the input operates like an NO contact (Normally open). If the parameter **Inverted** is validated, the input operates like an NC contact (Normally closed).*

Communication objects: **11 - Input 1 - Windows contact** (1 Bit – 1.002 DPT_Bool)
 21 - Input 2 - Windows contact (1 Bit – 1.002 DPT_Bool)

Communication objects: **15 - Input 1 - Windows contact** (1 Bit – 1.002 DPT_Bool)
 25 - Input 2 - Windows contact (1 Bit – 1.002 DPT_Bool)

3.1.3.13 Tariff

The Tariff function enables Full Hour (FH) or Part Hour (PH) information to be sent to the KNX bus.

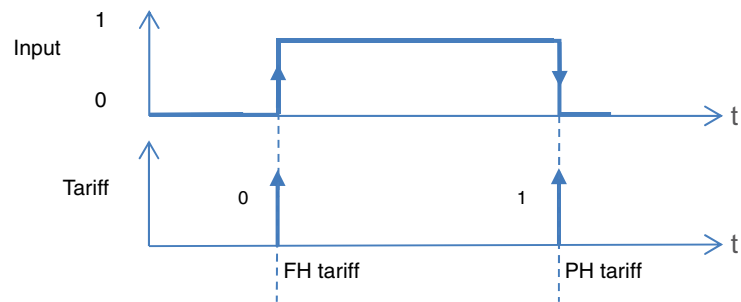

*Note: By default, the input operates like an NO contact (Normally open). If the parameter **Inverted** is validated, the input operates like an NC contact (Normally closed).*

Communication objects: **15 - Input 1 - Tariff** (1 Byte – 5.006 DPT_Tariff)

25 - Input 2 - Tariff (1 Byte – 5.006 DPT_Tariff)

Communication objects: **19 - Input 1 - Tariff** (1 Byte – 5.006 DPT_Tariff)

29 - Input 2 - Tariff (1 Byte – 5.006 DPT_Tariff)

3.2 Communication objects

3.2.1 Output communication objects ON/OFF

- TRM690G

	Number	Name	Function of the object	Length	C	R	W	T
	0	Output	ON/OFF	1 bit	C	R	W	-
	4	Output	ON/OFF automatic control	1 bit	C	R	W	-
	6	Output	Automatic control deactivation	1 bit	C	R	W	-
	7	Output	Automatic control deactivation status	1 bit	C	R	-	T
	8	Output	Status indication ON/OFF	1 bit	C	R	-	T
	10	Output	Timer	1 bit	C	R	W	-
	11	Output	Scene	1 byte	C	R	W	-
	12	Output	Priority	2 bit	C	R	W	-
	13	Output	Status indication priority	1 bit	C	R	-	T

- TRM693G - TRM694G

	Number	Name	Function of the object	Length	C	R	W	T
	0	Output	ON/OFF	1 bit	C	R	W	-
	1	Output	Status indication ON/OFF	1 bit	C	R	-	T
	2	Output	Timer	1 bit	C	R	W	-
	3	Output	Priority	2 bit	C	R	W	-
	4	Output	Status indication priority	1 bit	C	R	-	T
	5	Output	Scene	1 byte	C	R	W	-
	6	Output	ON/OFF automatic control	1 bit	C	R	W	-
	7	Output	Automatic control deactivation	1 bit	C	R	W	-
	8	Output	Automatic control deactivation status	1 bit	C	R	-	T
	9	Output	Load shedding	1 bit	C	R	W	-

3.2.1.1 ON/OFF

No.	Name	Function of the object	Data type	Flags
0	Output	ON/OFF	1 bit - 1.001 DPT_Switch	C, R, W

These objects are always activated.
They enable switching of the output contact in accordance with the value that is sent via the KNX bus.

Normally open:

- On input of an OFF command, the output relay contact opens.
- On input of an ON command, the output relay contact closes.

3.2.1.2 Status indication

No.	Name	Function of the object	Data type	Flags
1, 8	Output	Status indication ON/OFF	1 bit - 1.001 DPT_Switch	C, R, T

These objects are always activated.
This object allows the status of the output contact to be sent from the device over the KNX bus.

Object value:

- If the output relay is open, a telegram with logic value 0 is sent on the KNX bus.
- If the output relay is closed, a telegram with logic value 1 is sent on the KNX bus.

This object is sent when there is a status change.

3.2.1.3 Timer

No.	Name	Function of the object	Data type	Flags
2, 10	Output	Timer	1 bit - 1.010 DPT_Start	C, R, W

This object is activated when the **Timer** parameter is active.
This object is used to activate the Timer function of the device via the KNX bus.

Object value:

- If a rising edge (0 to 1) arrives at this object, the output switches for a configurable period.
- If a falling edge (1 to 0) arrives at this object, the output remains in its current state.

Note: The timer duration can be interrupted by a long press on the button controlling the timer.
Note: When a start command is received during the timer, the timer duration is reset.

For further information, see: [Timer](#).

3.2.1.4 Priority

No.	Name	Function of the object	Data type	Flags
3, 12	Output	Priority	2 bit - 2.002 DPT_Bool_Control	C, R, W

This object is activated if the **Priority** parameter is active.
The status of the output contact is determined directly by this object.
Details on the format of the object are given below.

Telegram received by the priority operation object			Output behaviour
Hexadecimal Value	Binary Value		
	Bit 1 (MSB)	Bit 0 (LSB)	
00	0	0	End of the priority
01	0	1	End of the priority
02	1	0	Priority OFF
03	1	1	Priority ON

The first bit of this object (Bit 0) determines the status of the output contact, which should be priority controlled. The second bit activates or deactivates the Priority.

For further information, see: [Priority](#).

No.	Name	Function of the object	Data type	Flags
4, 13	Output	Status indication priority	1 bit - 1.011 DPT_State	C, R, T
<p>This object is activated if the Priority parameter is active. This object allows the status of the Priority to be sent from the device on the KNX bus.</p> <p>Object value: 0 = Not forced, 1 = Forced:</p> <ul style="list-style-type: none"> - If Priority is deactivated, a telegram is sent with logic value 0. - If Priority is activated, a telegram is sent with logic value 1. <p>This object is sent when there is a status change. For further information, see: Priority.</p>				

3.2.1.5 Scene

No.	Name	Function of the object	Data type	Flags																
5, 11	Output	Scene	1 byte - 18.001 DPT_SceneNumber	C, R, W																
<p>This object is activated when the Scene parameter is active. This object is used to recall or save a scene.</p> <p>Details on the format of the object are given below.</p> <table border="1" style="margin-left: auto; margin-right: auto;"> <tr> <td style="text-align: center;">7</td> <td style="text-align: center;">6</td> <td style="text-align: center;">5</td> <td style="text-align: center;">4</td> <td style="text-align: center;">3</td> <td style="text-align: center;">2</td> <td style="text-align: center;">1</td> <td style="text-align: center;">0</td> </tr> <tr> <td style="text-align: center;">Learning</td> <td style="text-align: center;">Not used</td> <td colspan="6" style="text-align: center;">Scene number</td> </tr> </table> <p>Bit 7: 0: The scene is called / 1: The scene is saved. Bit 6: Not used. Bit 5 to Bit 0: Scene numbers from 0 (Scene 1) to 63 (Scene 64).</p> <p>For further information, see: Scene.</p>					7	6	5	4	3	2	1	0	Learning	Not used	Scene number					
7	6	5	4	3	2	1	0													
Learning	Not used	Scene number																		

3.2.1.6 ON/OFF automatic control

No.	Name	Function of the object	Data type	Flags
6, 4	Output	ON/OFF automatic control	1 bit - 1.001 DPT_Switch	C, R, W
<p>This object is activated when the Automatic control parameter is active. They enable switching of the output contact in accordance with the value that is sent via the KNX bus.</p> <p>Normally open:</p> <ul style="list-style-type: none"> - On input of an OFF command, the output relay contact opens. - On input of an ON command, the output relay contact closes. <p>For further information, see: Automatic control.</p>				

3.2.1.7 Automatic control deactivation

No.	Name	Function of the object	Data type	Flags
7, 6	Output	Automatic control deactivation	1 bit - 1.003 DPT_Enable	C, R, W
<p>This object is activated when the Automatic control deactivation parameter is active. This object is used to activate the automatic control function.</p> <p>Object value:</p> <ul style="list-style-type: none"> - If the object receives the value 0, the automatic control function is inactive. - If the object receives the value 1, the automatic control function is active. <p>For further information, see: Automatic control.</p>				

No.	Name	Function of the object	Data type	Flags
8, 7	Output	Automatic control deactivation status	1 bit - 1.003 DPT_Enable	C, R, T
<p>This object is activated when the Automatic control deactivation parameter is active. This object is used to send the status of the Automatic control deactivation function of the device on the KNX bus.</p> <p>Object value:</p> <ul style="list-style-type: none"> - If the Automatic control deactivation function is deactivated, a telegram with a logical value 0 is sent. - If the Automatic control deactivation function is activated, a telegram with a logical value 1 is sent. <p>This object is sent when there is a status change. For further information, see: Automatic control.</p>				

3.2.1.8 Load shedding

No.	Name	Function of the object	Data type	Flags
9	Output	Load shedding	1 bit - 1.002 DPT_Bool	C, R, W
<p>This object is activated when the Load shedding parameter is active. This object is used to force an output to OFF.</p> <p>Object value:</p> <ul style="list-style-type: none"> - If the object receives the value 0, the output remains unchanged. - If the object receives the value 1, the output is forced to OFF. <p><i>Note: The Load shedding function is only available in products TRM693G and TRM694G.</i></p> <p>For further information, see: Load shedding.</p>				

3.2.2 Communication objects by input

- TRM690G

Channel function		Number	Name	Function of the object	Length	C	R	W	T
Toggle switch		14	Input 1	Status indication ON/OFF	1 bit	C	R	W	-
		15	Input 1	ON/OFF	1 bit	C	R	-	T
ON/OFF		15	Input 1	ON/OFF	1 bit	C	R	-	T
Timer		15	Input 1	Timer	1 bit	C	R	-	T
Shutter		15	Input 1	Up/down	1 bit	C	R	-	T
		16	Input 1	Stop (short press)	1 bit	C	R	-	T
		19	Input 1	Position in %	1 byte	C	R	-	T
Shutter/blind		15	Input 1	Up/down	1 bit	C	R	-	T
		16	Input 1	Step/stop (short press)	1 bit	C	R	-	T
		20	Input 1	Slat angle in %	1 byte	C	R	-	T
		19	Input 1	Position in %	1 byte	C	R	-	T
		20	Input 1	Slat angle in %	1 byte	C	R	-	T
Dimming		15	Input 1	ON/OFF	1 bit	C	R	-	T
		18	Input 1	Dimming	4 bit	C	R	-	T
		14	Input 1	Status indication ON/OFF	1 bit	C	R	W	-
		15	Input 1	ON/OFF	1 bit	C	R	-	T
		18	Input 1	Dimming	4 bit	C	R	-	T
		19	Input 1	Brightness value	1 byte	C	R	-	T
Heating		15	Input 1	Heating/Cooling	1 bit	C	R	-	T
		19	Input 1	Setpoint selection	1 byte	C	R	-	T
Priority		17	Input 1	Priority	2 bit	C	R	-	T
Scene		19	Input 1	Scene	1 byte	C	R	-	T
Alarm		15	Input 1	Alarm 1	1 bit	C	R	-	T
		15	Input 1	Alarm 2	1 bit	C	R	-	T
		15	Input 1	Alarm 3	1 bit	C	R	-	T
Automatic control		15	Input 1	Automatic control deactivation	1 bit	C	R	-	T
Load shedding		15	Input 1	Load shedding	1 bit	C	R	-	T
Windows contact		15	Input 1	Windows contact status	1 bit	C	R	-	T
Tariff		15	Input 1	Tariff	1 bit	C	R	-	T

Channel function		Number	Name	Function of the object	Length	C	R	W	T
Toggle switch		24	Input 2	Status indication ON/OFF	1 bit	C	R	W	-
		25	Input 2	ON/OFF	1 bit	C	R	-	T
ON/OFF		25	Input 2	ON/OFF	1 bit	C	R	-	T
Timer		25	Input 2	Timer	1 bit	C	R	-	T
Shutter		25	Input 2	Up/down	1 bit	C	R	-	T
		26	Input 2	Stop (short press)	1 bit	C	R	-	T
		29	Input 2	Position in %	1 byte	C	R	-	T
Shutter/blind		25	Input 2	Up/down	1 bit	C	R	-	T
		26	Input 2	Step/stop (short press)	1 bit	C	R	-	T
		30	Input 2	Slat angle in %	1 byte	C	R	-	T
		29	Input 2	Position in %	1 byte	C	R	-	T
		30	Input 2	Slat angle in %	1 byte	C	R	-	T
Dimming		25	Input 2	ON/OFF	1 bit	C	R	-	T
		28	Input 2	Dimming	4 bit	C	R	-	T
		24	Input 2	Status indication ON/OFF	1 bit	C	R	W	-
		25	Input 2	ON/OFF	1 bit	C	R	-	T
		28	Input 2	Dimming	4 bit	C	R	-	T
		29	Input 2	Brightness value	1 byte	C	R	-	T
Heating		25	Input 2	Heating/Cooling	1 bit	C	R	-	T
		29	Input 2	Setpoint selection	1 byte	C	R	-	T
Priority		27	Input 2	Priority	2 bit	C	R	-	T
Scene		29	Input 2	Scene	1 byte	C	R	-	T
Alarm		25	Input 2	Alarm 1	1 bit	C	R	-	T
		25	Input 2	Alarm 2	1 bit	C	R	-	T
		25	Input 2	Alarm 3	1 bit	C	R	-	T
Automatic control		25	Input 2	Automatic control deactivation	1 bit	C	R	-	T
Load shedding		25	Input 2	Load shedding	1 bit	C	R	-	T
Windows contact		25	Input 2	Windows contact status	1 bit	C	R	-	T
Tariff		25	Input 2	Tariff	1 bit	C	R	-	T

- TRM693G - TRM694G

Channel function		Number	Name	Function of the object	Length	C	R	W	T
Toggle switch		10	Input 1	Status indication ON/OFF	1 bit	C	R	W	-
		11	Input 1	ON/OFF	1 bit	C	R	-	T
ON/OFF		11	Input 1	ON/OFF	1 bit	C	R	-	T
Timer		11	Input 1	Timer	1 bit	C	R	-	T
Shutter		11	Input 1	Up/down	1 bit	C	R	-	T
		12	Input 1	Stop (short press)	1 bit	C	R	-	T
		15	Input 1	Position in %	1 byte	C	R	-	T
Shutter/blind		11	Input 1	Up/down	1 bit	C	R	-	T
		12	Input 1	Step/stop (short press)	1 bit	C	R	-	T
		16	Input 1	Slat angle in %	1 byte	C	R	-	T
		15	Input 1	Position in %	1 byte	C	R	-	T
		16	Input 1	Slat angle in %	1 byte	C	R	-	T
Dimming		11	Input 1	ON/OFF	1 bit	C	R	-	T
		14	Input 1	Dimming	4 bit	C	R	-	T
		10	Input 1	Status indication ON/OFF	1 bit	C	R	W	-
		11	Input 1	ON/OFF	1 bit	C	R	-	T
		14	Input 1	Dimming	4 bit	C	R	-	T
		15	Input 1	Brightness value	1 byte	C	R	-	T
Heating		11	Input 1	Heating/Cooling	1 bit	C	R	-	T
		15	Input 1	Setpoint selection	1 byte	C	R	-	T
Priority		13	Input 1	Priority	2 bit	C	R	-	T
Scene		15	Input 1	Scene	1 byte	C	R	-	T
Alarm		11	Input 1	Alarm 1	1 bit	C	R	-	T
		11	Input 1	Alarm 2	1 bit	C	R	-	T
		11	Input 1	Alarm 3	1 bit	C	R	-	T
Automatic control		11	Input 1	Automatic control deactivation	1 bit	C	R	-	T
Load shedding		11	Input 1	Load shedding	1 bit	C	R	-	T
Windows contact		11	Input 1	Windows contact status	1 bit	C	R	-	T
Tariff		11	Input 1	Tariff	1 bit	C	R	-	T

Channel function		Number	Name	Function of the object	Length	C	R	W	T
Toggle switch		20	Input 2	Status indication ON/OFF	1 bit	C	R	W	-
		21	Input 2	ON/OFF	1 bit	C	R	-	T
ON/OFF		21	Input 2	ON/OFF	1 bit	C	R	-	T
Timer		21	Input 2	Timer	1 bit	C	R	-	T
Shutter		21	Input 2	Up/down	1 bit	C	R	-	T
		22	Input 2	Stop (short press)	1 bit	C	R	-	T
		25	Input 2	Position in %	1 byte	C	R	-	T
Shutter/blind		21	Input 2	Up/down	1 bit	C	R	-	T
		22	Input 2	Step/stop (short press)	1 bit	C	R	-	T
		26	Input 2	Slat angle in %	1 byte	C	R	-	T
		25	Input 2	Position in %	1 byte	C	R	-	T
		26	Input 2	Slat angle in %	1 byte	C	R	-	T
Dimming		21	Input 2	ON/OFF	1 bit	C	R	-	T
		24	Input 2	Dimming	4 bit	C	R	-	T
		20	Input 2	Status indication ON/OFF	1 bit	C	R	W	-
		21	Input 2	ON/OFF	1 bit	C	R	-	T
		24	Input 2	Dimming	4 bit	C	R	-	T
	25	Input 2	Brightness value	1 byte	C	R	-	T	
Heating		21	Input 2	Heating/Cooling	1 bit	C	R	-	T
		25	Input 2	Setpoint selection	1 byte	C	R	-	T
Priority		23	Input 2	Priority	2 bit	C	R	-	T
Scene		25	Input 2	Scene	1 byte	C	R	-	T
Alarm		21	Input 2	Alarm 1	1 bit	C	R	-	T
		21	Input 2	Alarm 2	1 bit	C	R	-	T
		21	Input 2	Alarm 3	1 bit	C	R	-	T
Automatic control		21	Input 2	Automatic control deactivation	1 bit	C	R	-	T
Load shedding		21	Input 2	Load shedding	1 bit	C	R	-	T
Windows contact		21	Input 2	Windows contact status	1 bit	C	R	-	T
Tariff		21	Input 2	Tariff	1 bit	C	R	-	T

3.2.2.1 ON/OFF and toggle switch

No.	Name	Function of the object	Data type	Flags
11, 21 - 15, 25	Input x	ON/OFF	1 bit - 1.001 DPT_Switch	C, R, T
<p>This object is activated when the parameter Channel function has the value Toggle switch, ON/OFF or Dimming.</p> <p>This object enables the ON/OFF control to be issued from the input contact on the KNX bus.</p> <ul style="list-style-type: none"> - To issue an OFF command, a telegram with a logical value 0 is issued. - To issue an ON command, a telegram with a logical value 1 is issued. <p>This object is sent when there is a status change.</p> <p><i>Note: By default, the input operates like an NO contact (Normally open). If the parameter Inverted is validated, the input operates like an NC contact (Normally closed).</i></p> <p>For further information, see: ON/OFF or Toggle switch.</p>				

No.	Name	Function of the object	Data type	Flags
10, 20 - 14, 24	Input x	Status indication ON/OFF	1 bit - 1.001 DPT_Switch	C, R, W
<p>This object is activated when the parameter Channel function has the value Toggle switch or Dimming.</p> <p>This object enables the status of the ON/OFF output sent to the KNX bus to be received.</p> <ul style="list-style-type: none"> - If the object receives the value 0, the status indication changes to OFF. - If the object receives the value 1, the status indication changes to ON. <p><i>Note: By default, the input operates like an NO contact (Normally open). If the parameter Inverted is validated, the input operates like an NC contact (Normally closed).</i></p> <p>For further information, see: ON/OFF or Toggle switch.</p>				

3.2.2.2 Timer

No.	Name	Function of the object	Data type	Flags
11, 21 - 15, 25	Input x	Timer	1 bit - 1.001 DPT_Switch	C, R, T
<p>This object is activated when the parameter Channel function has the value Timer.</p> <p>This object enables the Timer command to be issued from the input contact on the KNX bus.</p> <ul style="list-style-type: none"> - To issue a Timer command, a telegram with a logical value 1 is issued. <p>For further information, see: Timer.</p>				

3.2.2.3 Shutter and blind

No.	Name	Function of the object	Data type	Flags
11, 21 - 15, 25	Input x	Up/down	1 bit - 1.008 DPT_UpDown	C, R, T
<p>This object is activated when the parameter Channel function has the value Shutter/blind.</p> <p>This object enables the UP/Down command to be sent from the input contact on the KNX bus.</p> <ul style="list-style-type: none"> - To issue an Up command, a telegram with a logical value 0 is issued. - To issue a Down command, a telegram with a logical value 1 is issued. <p>This object is sent when there is a status change.</p> <p><i>Note: By default, the input operates like an NO contact (Normally open). If the parameter Inverted is validated, the input operates like an NC contact (Normally closed).</i></p> <p>For further information, see: Shutter and blind.</p>				

No.	Name	Function of the object	Data type	Flags
12, 22 - 16, 26	Input x	Stop (short press)	1 bit - 1.017 DPT_Trigger	C, R, T
<p>This object is activated when the parameter Channel function has the value Shutter/blind.</p> <p>This object enables the Stop command to be issued from the input contact on the KNX bus.</p> <ul style="list-style-type: none"> - To issue a Stop command, a telegram with a logical value 1 is issued. <p>This object is sent when there is a status change. For further information, see: Shutter and blind.</p>				

No.	Name	Function of the object	Data type	Flags
15, 25 - 19, 29	Input x	Position in %	1 byte - 5.001 DPT_Scaling	C, R, T
<p>This object is activated when the parameter Channel function has the value Shutter/blind.</p> <p>This object enables the shutter or blind position command to be issued from the input contact on the KNX bus.</p> <p>Object value: 0 to 255</p> <ul style="list-style-type: none"> - 0 (0%): Upper position. - 255 (100%): Lower position. <p>This object is sent when there is a status change. For further information, see: Shutter and blind.</p>				

No.	Name	Function of the object	Data type	Flags
12, 22 - 16, 26	Input x	Step/stop (short press)	1 bit - 1.007 DPT_Step	C, R, T
<p>This object is activated when the parameter Channel function has the value Shutter/blind.</p> <p>This object enables the Stop command to be issued from the input contact on the KNX bus.</p> <ul style="list-style-type: none"> - To issue a Stop command, a telegram with a logical value 0 or 1 is issued. - To issue a slat opening command, a telegram with a logical value 0 is issued. - To issue a slat closing command, a telegram with a logical value 1 is issued.. <p>This object is sent when there is a status change. For further information, see: Shutter and blind.</p>				

No.	Name	Function of the object	Data type	Flags
16, 26 - 20, 30	Input x	Slat angle in %	1 byte - 5.001 DPT_Scaling	C, R, T
<p>This object is activated when the parameter Channel function has the value Shutter/blind.</p> <p>This object enables the slat angle command to be issued from the input contact on the KNX bus.</p> <p>Object value: 0 to 255</p> <ul style="list-style-type: none"> - 0 (0%): Slats open. - 255 (100%): Slats closed. <p>This object is sent when there is a status change. For further information, see: Shutter and blind.</p>				

3.2.2.4 Dimming

No.	Name	Function of the object	Data type	Flags
14, 24 - 18, 28	Input x	Dimming	4 bit - 3.007 DPT_Control_Dimming	C, R, T

This object is activated when the parameter **Channel function** has the value **Dimming**.
This object enables the dimming command relating to the brightness to be issued from the input contact on the KNX bus.

Object value:

b3	b2	b1	b0
C	Steps		

Data fields	Description	Code
C	Increase or reduction in brightness	0: Decrease 1: Increase
Steps	Brightness between 0% and 100% divided into steps	0: Stop 1: 100% 2: 50% 3: 25% 4: 12% 5: 6% 6: 3% 7: 1%

This object is sent when there is a status change.
For further information, see: [Dimming](#).

No.	Name	Function of the object	Data type	Flags
15, 25 - 19, 29	Input x	Brightness value	1 byte - 5.001 DPT_Scaling	C, R, T

This object is activated when the parameter **Channel function** has the value **Dimming**.
This object enables the brightness absolute dimming command to be issued from the input on the KNX bus.

Object value: 0 to 255: 0 = 0%, 255 = 100%.
Resolution: Approx. 0.4%.

This object is sent when there is a status change.
For further information, see: [Dimming](#).

3.2.2.5 Heating

No.	Name	Function of the object	Data type	Flags
11, 21 - 15, 25	Input x	Heating/Cooling - changeover	1 bit - 1.100 DPT_Heating/cooling	C, R, T

This object is activated when the parameter **Channel function** has the value **Heating**.

This object enables the heating system operating mode to be issued from the input contact on the KNX bus.

- To issue the heating information, a telegram with a logical value 1 is issued.
- To issue the cooling information, a telegram with logical value 0 is issued.

This object is sent when there is a status change.

*Note: By default, the input operates like an NO contact (Normally open). If the parameter **Inverted** is validated, the input operates like an NC contact (Normally closed).*

For further information, see: [Heating](#).

No.	Name	Function of the object	Data type	Flags
15, 25 - 19, 29	Input x	Setpoint selection	1 byte - 20.102 DPT_HVAC mode	C, R, T

This object is activated when the parameter **Channel function** has the value **Heating**.

This object enables the heating mode to be issued from the input contact on the KNX bus.

Depending on the status of the input contact (open or closed), a heating mode is issued for each status.

Heating mode	Value
Auto	0
Comfort	1
Standby	2
Night setpoint	3
Frost protection	4

This object is sent when there is a status change.

For further information, see: [Heating](#).

3.2.2.6 Priority

No.	Name	Function of the object	Data type	Flags																											
13, 23 - 17, 27	Input x	Priority	2 bit - 2.002 DPT_Bool_Control	C, R, T																											
<p>This object is activated when the parameter Channel function has the value Priority. This object enables the Priority command to be issued from the input contact on the KNX bus.</p> <p>Details on the format of the object are given below.</p> <table border="1" style="margin-left: 40px;"> <thead> <tr> <th colspan="3">Telegram received by the priority operation object</th> <th rowspan="2">Output behaviour</th> </tr> <tr> <th rowspan="2">Hexadecimal Value</th> <th colspan="2">Binary Value</th> </tr> <tr> <th></th> <th>Bit 1 (MSB)</th> <th>Bit 0 (LSB)</th> <th></th> </tr> </thead> <tbody> <tr> <td>00</td> <td>0</td> <td>0</td> <td>End of the priority</td> </tr> <tr> <td>01</td> <td>0</td> <td>1</td> <td>End of the priority</td> </tr> <tr> <td>02</td> <td>1</td> <td>0</td> <td>Priority OFF/up/frost protection</td> </tr> <tr> <td>03</td> <td>1</td> <td>1</td> <td>Priority ON/down/comfort</td> </tr> </tbody> </table> <p>The first bit of this object (Bit 0) determines the status of the output contact, which should be priority controlled. The second bit activates or deactivates the Priority.</p> <p><i>Note: By default, the input operates like an NO contact (Normally open). If the parameter Inverted is validated, the input operates like an NC contact (Normally closed).</i></p> <p>For further information, see: Priority.</p>					Telegram received by the priority operation object			Output behaviour	Hexadecimal Value	Binary Value			Bit 1 (MSB)	Bit 0 (LSB)		00	0	0	End of the priority	01	0	1	End of the priority	02	1	0	Priority OFF/up/frost protection	03	1	1	Priority ON/down/comfort
Telegram received by the priority operation object			Output behaviour																												
Hexadecimal Value	Binary Value																														
		Bit 1 (MSB)	Bit 0 (LSB)																												
00	0	0	End of the priority																												
01	0	1	End of the priority																												
02	1	0	Priority OFF/up/frost protection																												
03	1	1	Priority ON/down/comfort																												

3.2.2.7 Scene

No.	Name	Function of the object	Data type	Flags																
15, 25 - 19, 29	Input x	Scene	1 byte - 18.001 DPT_SceneControl	C, R, T																
<p>This object is activated when the parameter Channel function has the value Scene. This object enables the scene number to be issued from the input contact on the KNX bus. It also memorises a scene.</p> <p>Details on the format of the object are given below.</p> <table border="1" style="margin-left: 40px;"> <thead> <tr> <th>7</th> <th>6</th> <th>5</th> <th>4</th> <th>3</th> <th>2</th> <th>1</th> <th>0</th> </tr> </thead> <tbody> <tr> <td>Learning</td> <td>Not used</td> <td colspan="6">Scene number</td> </tr> </tbody> </table> <p>Bit 7: 0: The scene is called / 1: The scene is saved. Bit 6: Not used. Bit 5 to Bit 0: Scene numbers from 0 (Scene 1) to 63 (Scene 64).</p> <p>For further information, see: Scene.</p>					7	6	5	4	3	2	1	0	Learning	Not used	Scene number					
7	6	5	4	3	2	1	0													
Learning	Not used	Scene number																		

3.2.2.8 Alarm

No.	Name	Function of the object	Data type	Flags
11, 21 - 15, 25	Input x	Alarm 1	1 bit - 1.005 DPT_Alarm	C, R, T
11, 21 - 15, 25	Input x	Alarm 2	1 bit - 1.005 DPT_Alarm	C, R, T
11, 21 - 15, 25	Input x	Alarm 3	1 bit - 1.005 DPT_Alarm	C, R, T

This object is activated when the parameter **Channel function** has the value **Alarm**.

This object enables the alarm command to be issued from the input contact on the KNX bus.

- To issue an inactive alarm command, a telegram with a logical value 0 is issued.
- To issue an active alarm command, a telegram with a logical value 1 is issued.

This object is sent when there is a status change.

*Note: By default, the input operates like an NO contact (Normally open). If the parameter **Inverted** is validated, the input operates like an NC contact (Normally closed).*

For further information, see: [Alarm](#).

3.2.2.9 Automatic control

No.	Name	Function of the object	Data type	Flags
11, 21 - 15, 25	Input x	Automatic control deactivation	1 bit - 1.003 DPT_Enable	C, R, T

This object is activated when the parameter **Channel function** has the value **Automatic control deactivation**.

This object enables the automatic control deactivation command to be issued from the input contact on the KNX bus.

- To issue an inactive automatic control command, a telegram with a logical value 0 is issued.
- To issued an active automatic control command, a telegram with a logical value 1 is issued.

This object is sent when there is a status change.

*Note: By default, the input operates like an NO contact (Normally open). If the parameter **Inverted** is validated, the input operates like an NC contact (Normally closed).*

For further information, see: [Automatic control deactivation](#).

3.2.2.10 Load shedding

No.	Name	Function of the object	Data type	Flags
11, 21 - 15, 25	Input x	Load shedding	1 bit - 1.002 DPT_Bool	C, R, T

This object is activated when the parameter **Channel function** has the value **Load shedding**.

This object enables the load-shedding command to be issued from the input contact on the KNX bus.

- To issue a load-shedding command (forcing the output to OFF), a telegram with a logical value 1 is issued.

This object is sent when there is a status change.

*Note: By default, the input operates like an NO contact (Normally open). If the parameter **Inverted** is validated, the input operates like an NC contact (Normally closed).*

For further information, see: [Load shedding](#).

3.2.2.11 Windows contact

No.	Name	Function of the object	Data type	Flags
11, 21 - 15, 25	Input x	Windows contact status	1 bit - 1.019 DPT_window/door	C, R, T
<p>This object is activated when the parameter Channel function has the value Windows contact.</p> <p>This object enables the status of a window contact to be issued from the input contact on the KNX bus.</p> <ul style="list-style-type: none"> - To signal a closed window contact, a telegram with a logical value 1 is issued. - To signal an open window contact, a telegram with a logical value 0 is issued. <p>This object is sent when there is a status change.</p> <p><i>Note: By default, the input operates like an NO contact (Normally open). If the parameter Inverted is validated, the input operates like an NC contact (Normally closed).</i></p> <p>For further information, see: Windows contact.</p>				

3.2.2.12 Tariff

No.	Name	Function of the object	Data type	Flags
11, 21 - 15, 25	Input x	Tariff	1 bit - 5.006 DPT_Tariff	C, R, T
<p>This object is activated when the parameter Channel function has the value Tariff.</p> <p>This object enables the tariff status to be issued from the input contact on the KNX bus.</p> <ul style="list-style-type: none"> - To issue the Full Hour (FH) tariff information, a telegram with a 2 value is issued. - To issue the Part Hour (PH) tariff information, a telegram with a 1 value is issued. <p>This object is sent when there is a status change.</p> <p><i>Note: By default, the input operates like an NO contact (Normally open). If the parameter Inverted is validated, the input operates like an NC contact (Normally closed).</i></p> <p>For further information, see: Tariff.</p>				

3.3 Configuration with media coupler

■ Configuration principle

The TR131 media coupler enables configuration by ETS of RF devices for a KNX radio installation or a mixed KNX installation including RF devices and wired buses. For normal operation, the radio transmitters operate in a one-direction mode. Configuration takes place in bi-directional mode.

■ Implementation recommendations

1. The Media coupler must remain in place after configuration. It sends the commands between the radio products and the wired products in auto mode.
2. The coupler must be at the head of the line: x.y.0 type physical address.
3. The coupler must be in a different line than the USB/series/IP interface.
4. Use of old generation media couplers (TR130A/B) is not authorised in an installation containing a new media coupler (TR131A/B).
5. Separate the radio and TP lines:
 - The radio line must not contain TP products: The views of the line in ETS and in the plug-in would contain inconsistencies.
 - The TP lines must not contain radio products: It would be impossible to configure these radio products.
6. Only use the plug-in to program the physical addresses and download the products. As ETS cannot program radio products, it is not possible to use the usual configuration menus.
7. The product copy function must not be used in ETS for radio products. It causes inconsistencies in the projects leading to plug-in malfunctions.
8. Copying projects which already contain a configured media coupler leads to plug-in malfunctions.
9. The use of the "default" button in the ETS parameter setting window is not recommended. This results in:
 - The loss of the parameters of a product which has already been configured.
 - Desynchronisation between the plug-in data and the radio products which have already been configured.
10. During the physical addressing, the download or the factory reset procedures of unidirectional radio products, several attempts may be needed for a successful completion of the procedure.
11. Changing the line of a media coupler which is already configured leads to plug-in malfunctions.
12. Do not use ETS Software function Unload/Unload application.

■ Installation procedure

- Create a line reserved for RF devices in your ETS plan,
- First insert the media coupler into this line, then insert the other RF devices into this line.
- Perform the programming, parameter settings and group addressing for all the RF products except for the media coupler.
- Download the physical address of the media coupler. This must be of the type 1.1.0 (always end with a zero).
- Install the media coupler plug-in: Right-click on the product in the ETS tree structure, then select edit the parameters. Windows Administrator rights are necessary to install the plug in.

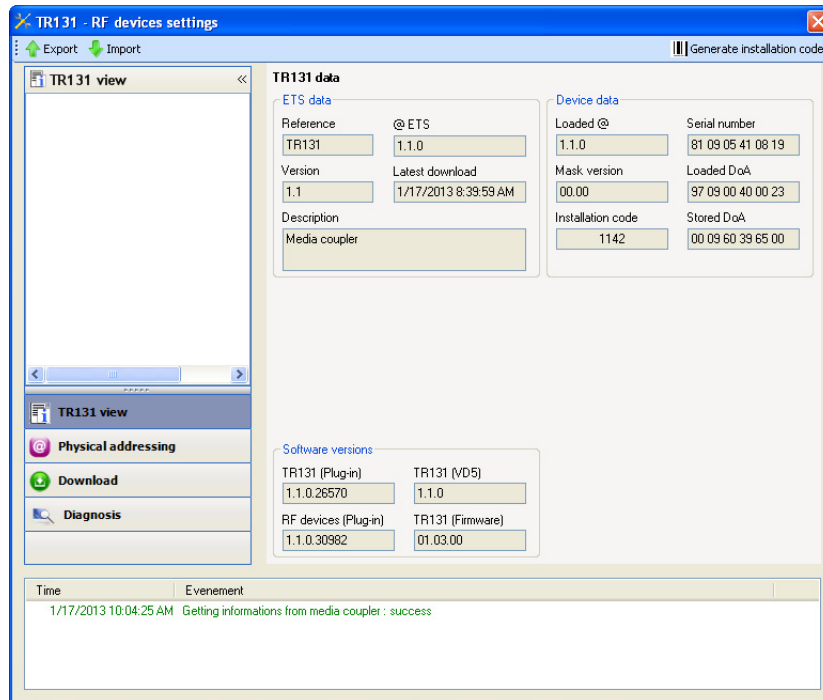

Physical addressing of the radio transmitters

- Click on the button **Physical addressing** to display the physical addressing screen for the plug in.
- Select the device to be addressed, then click on the field **Addressing** in the menu line at the upper left of the window.
- Click on **Product search**, if the product is not found by the search, perform a factory reset on the product outside the installation.
- Select the device to be addressed and click on **Attribute address**. The physical addressing of the product is performed. The product is now part of the installation.
- After downloading the physical address, the  symbol appears in front of the product.
- Repeat this operation for the other radio transmitters.

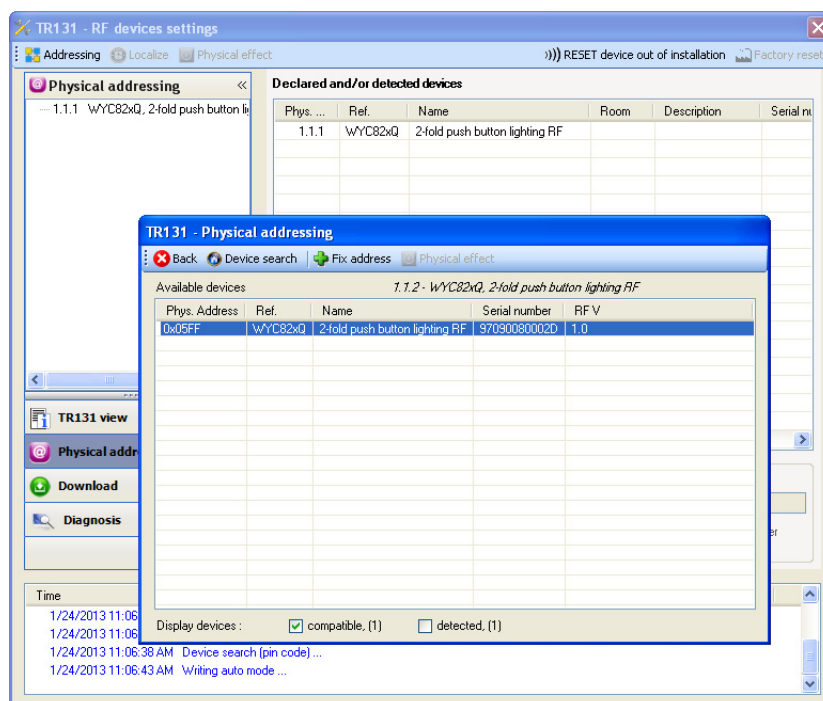

■ Downloading the program and the parameters

This operation is performed using the plug-in. There are 2 ways of accessing the **Download** view.

- From the media coupler
 - Right-click on the product in the ETS tree structure, then select **edit the parameters**.
 - Click on **Download** and follow the instructions on the screen.
- From the RF product to be downloaded
 - Right click on the product in the ETS tree structure, then select **Download RF product...** and follow the instructions on the screen.

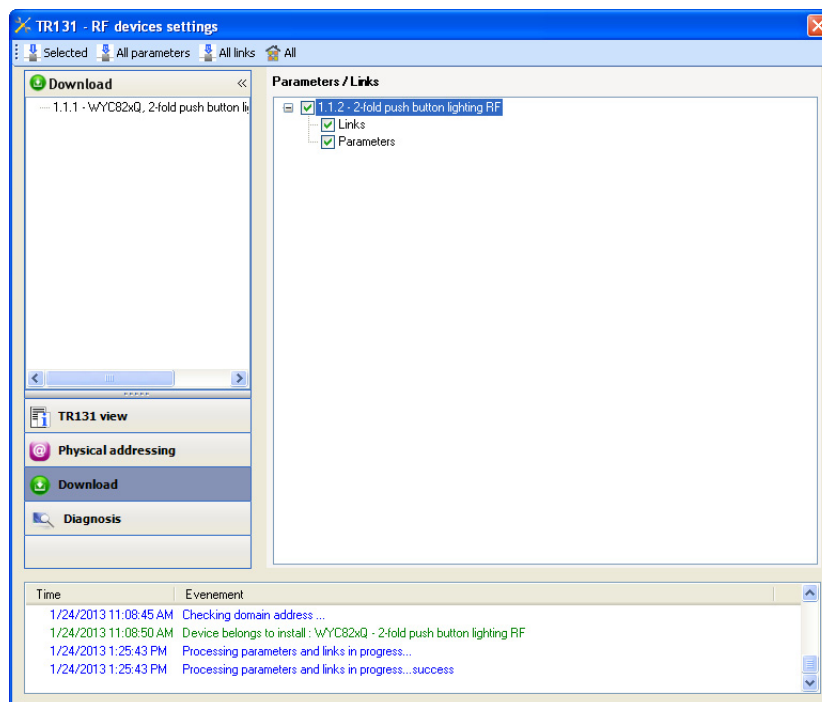

The right-hand window allows you to select the parameters and/or links to be downloaded for each product.

Finalise the download by selecting the type of download in the upper bar.

- **Selected** to download the selected parameters and links.
- **All parameters** to download all the parameters of all the products displayed.
- **All links** to download all the links for all the products displayed.
- **All** to download all the parameters and all the links of all the products displayed.

To test the functions and the KNX radio communication, return to normal use mode and wait 15 s before pressing a control button on a transmitter.

Warning: The media coupler plug-in must be deactivated during the functional tests.

NB: For more information, refer to the description for the TR131 application software.

■ Repeater Function

It increases the radio range of the system by re-sending the messages received by the product.

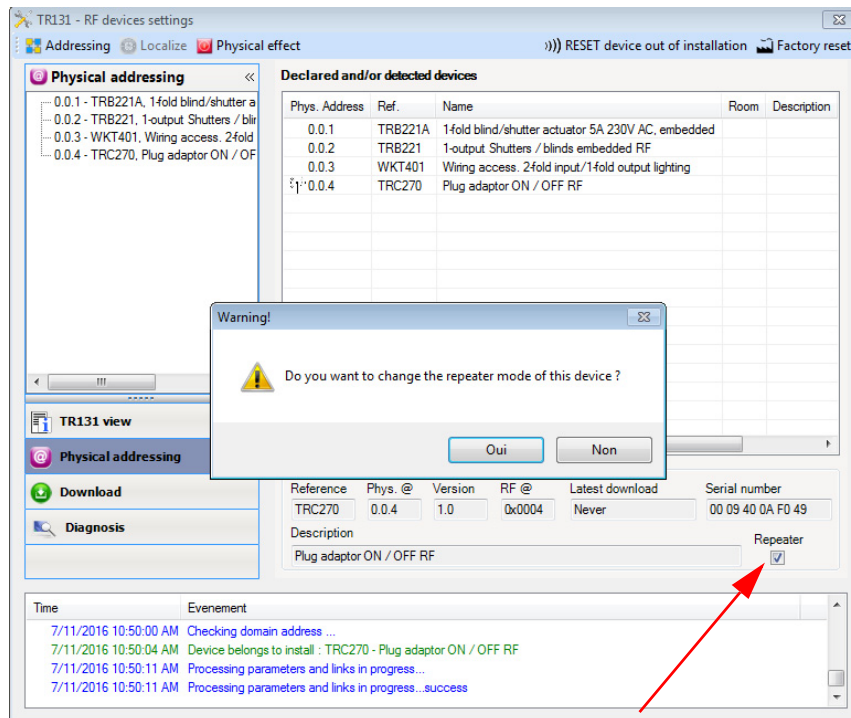

To activate the Repeater function, tick the repeater box on the physical addressing screen of the product concerned.

Note: The Repeater function is only available in TRM693G and TRM694G products.

4. Programming by Easy Tool

The function of the different devices only differs in the number of outputs. For this reason, only one device or one output will ever be described.

4.1 Product overview

- TRM693G: 1 output 3A 230V + 2-fold embedded input KNX radio

Product view:

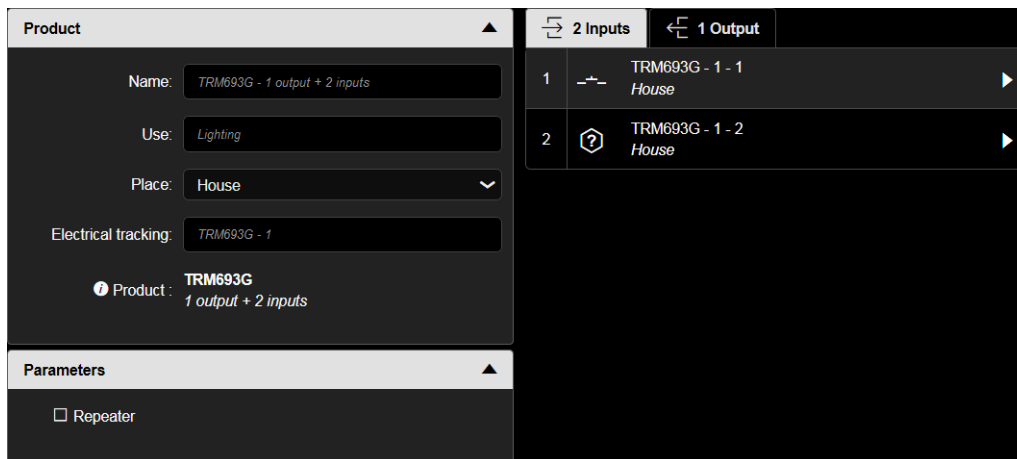

View of channels:

2 inputs	
	TRM693G - 1 - 1 Housing
	TRM693G - 1 - 2 Housing

1 Output	
	TRM693G - 1 - 1 Housing - Lighting

The symbol means that the input and output are connected by default. After every product device reset, this link will be automatically re-established with the function by default.

- Product settings

This configuration window is used for general configuration of the device.



- Pathway parameters

This parameter window is used to set the device outputs. These parameters are available individually for each output.

- ON/OFF

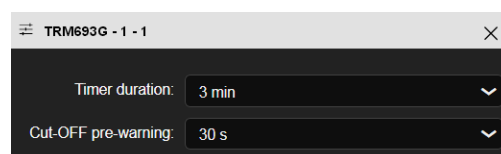

■ Available functionalities: Output ON/OFF

	ON		Automatic control ON
	OFF		Automatic control OFF
	ON/OFF		ON/OFF automatic control
	Toggle switch		Load shedding (2)
	Timer		Scene
	Priority ON		Scene switch
	Priority OFF		Automatic control deactivation
	Priority ON push-button (1)		Deactivation Automatic control push-button (1)
	Priority OFF push-button (1)		

(1) This function is only available with push-button input products with LEDs indicating status.

(2) The Load shedding function is only available in products TRM693G and TRM694G.

Note: Dimming functions can also be linked with ON/OFF outputs. In this case, only the ON/OFF function is used. This procedure enables a same input to be connected to an ON/OFF output and to a dimming output.

















	Increase dimming/ON
	Decrease dimming/OFF
	Increase/decrease dimming





■ Available functionalities: Input

Lighting			
	ON		Automatic control ON
	OFF		Automatic control OFF
	ON/OFF		ON/OFF automatic control
	Toggle switch		Load shedding
	Timer		Automatic control deactivation
	Priority ON		Scene
	Priority OFF		Scene switch

Dimming			
	Increase dimming/ON		Dimming automatic control PB
	Decrease dimming/OFF		Dimmer switch automatic control
	Increase/decrease dimming		Scene
	Dimming		Scene switch
	Dimming switch		Automatic control deactivation

Shutter/blind			
	Blinds up		Priority up
	Blinds down		Priority down
	Shutter UP		Wind alarm
	Shutter DOWN		Rain alarm
	Up/down		Automatic control shutter angle
	Down/up		Automatic control slat angle
	Switch up		Automatic control shutter and slat angle
	Down switch		Automatic control shutter position switch
	Up/stop		Automatic control inter slat angle
	Down/stop		Automatic control inter shutter and slat angle
	Shutter position		Scene
	Slat angle		Scene switch
	Shutter and slat angle		Automatic control deactivation
	Shutter angle switch		
	Slat angle switch		
	Shutter and slat angle switch		

Heating/Cooling			
	Comfort mode		Comfort mode automatic control
	Eco mode		Eco mode automatic control
	Standby mode		Standby mode automatic control
	Protection mode		Protection mode automatic control
	Switch mode		Switch mode automatic control
	Heating/Cooling		Automatic control deactivation
	Comfort priority		Scene
	Protection priority		Scene switch

Metering			
	Tariff		Scene
	Automatic control deactivation		Scene switch

4.2 Repeater Function

It increases the radio range of the system by re-sending the messages received by the product.



To activate the Repeat function, tick the repeater box in the parameters for the affected product.

Note: The Repeater function is only available in TRM693G and TRM694G products.

4.3 Product functions at output

4.3.1 ON/OFF

An output can be switched on or off using the ON/OFF function. The command can come from switches, buttons or other control inputs.

- **ON:** Turns on the lighting circuit.

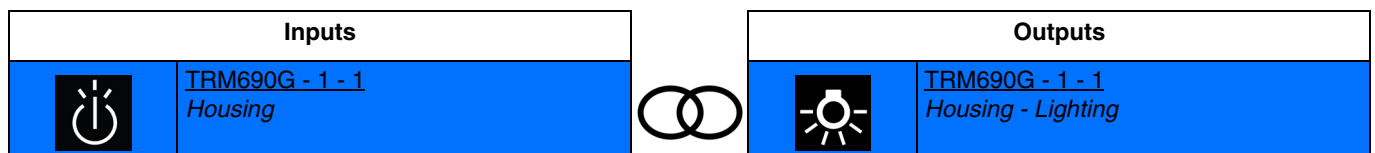

Closing input contact: turn on the light.
Opening input contact: no action.

- **OFF:** Turns off the lighting circuit.

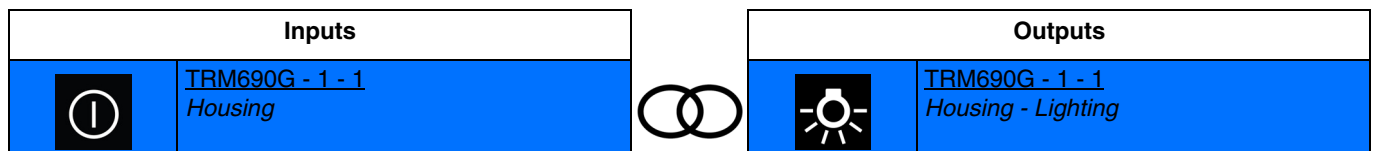

Closing input contact: turns off the light.
Opening input contact: no action.

- **ON/OFF:** Turns on or shuts off the lighting circuit (Switch).

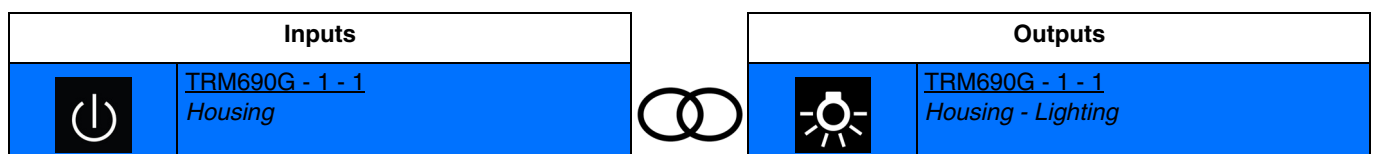

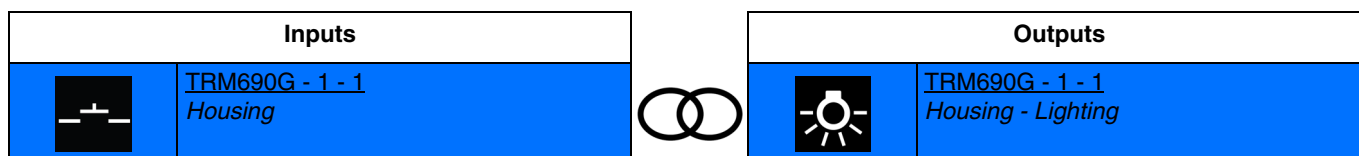

Closing input contact: turn on the light.
Opening input contact: turns off the light.

- **Toggle switch:** Inverses the lighting circuit status.



Closing input contact: switch between turning the lights on and off.
Successive closings inverse output contact status each time.

Note: Dimming functions can also be linked with ON/OFF outputs. In this case, only the ON/OFF function is used. This procedure enables a same input to be connected to an ON/OFF output and to a dimming output.

	Increase dimming/ON
	Decrease dimming/OFF
	Increase/decrease dimming

4.3.2 Timer

The Timer function is used to switch on a lighting circuit for a programmable period. The timer may be interrupted before expiry of the delay time. A programmable Cut-OFF pre-warning announces the end of the delay time by a 1-second inversion of the output status.

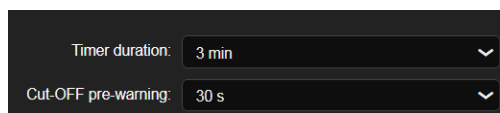

Parameter	Description	Value
Timer duration	This parameter determines the timer duration.	Not active, 1 s, 2 s, 3 s, 5 s, 10 s, 15 s, 20 s, 30 s, 45 s, 1 min, 1 min 15 s, 1 min 30 s, 2 min* , 2 min 30 s, 3 min, 5 min, 15 min, 20 min, 30 min, 1 h, 2 h, 3 h, 5 h, 12 h, 24 h

Parameter	Description	Value
Cut-OFF pre-warning	This parameter determines the lead time of the cut-OFF pre-warning.	Not active, 15 s, 30 s* , 1 min

* Default value

Operating principle:

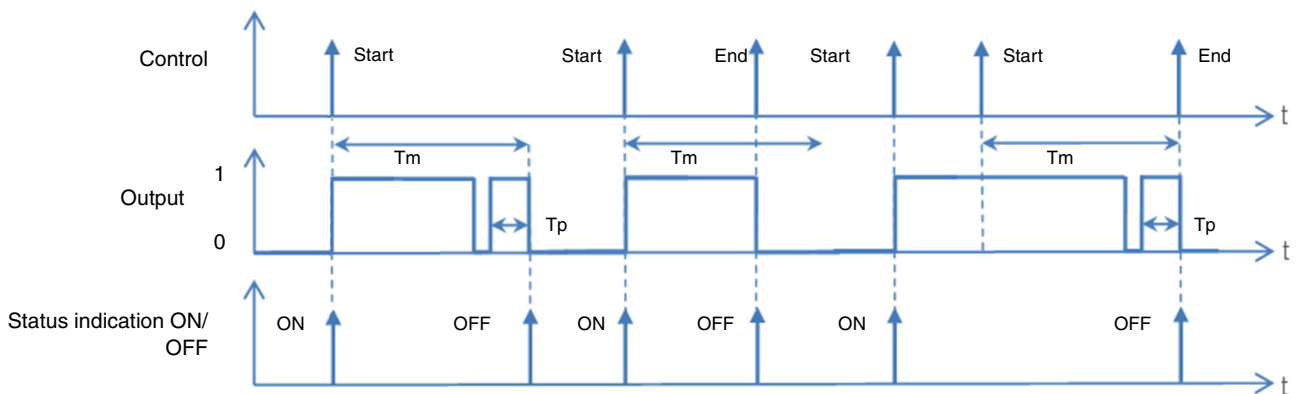

T_m : Timer duration
 T_p : Pre-warning lead time

Note: If the lead time of the cut-OFF pre-warning is greater than the duration of the timer, the cut-OFF pre-warning is not triggered.

■ The connection:

The Timer function is used to switch on a lighting circuit for a programmable period.

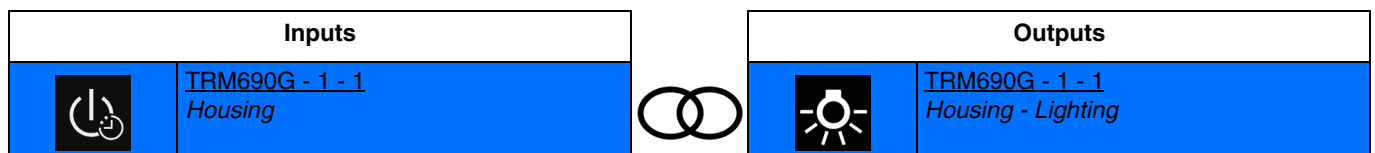

Brief closing of the input contact: timing function light switched on at the last saved level.

Timing function interruption:

Prolonged closing of the input contact: stop of timing delay in progress and light is turned off.

Note: At the time of connection, it is possible to define the timer duration.

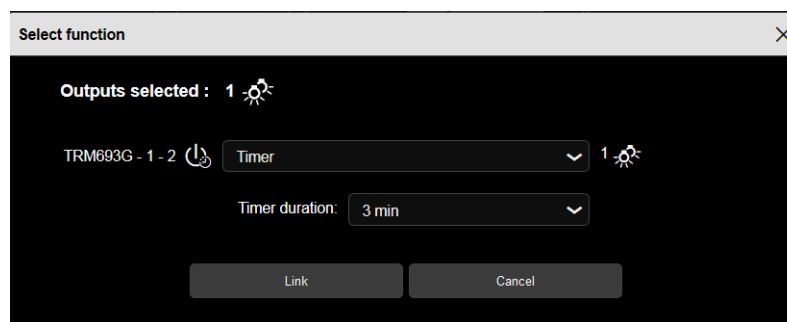

4.3.3 Priority

The Priority function is used to force the output into a defined state.

Priority: **Priority** > Basic function.

At the end of the priority, the output returns to the status it had before the priority (Memorisation function).

Operating principle:

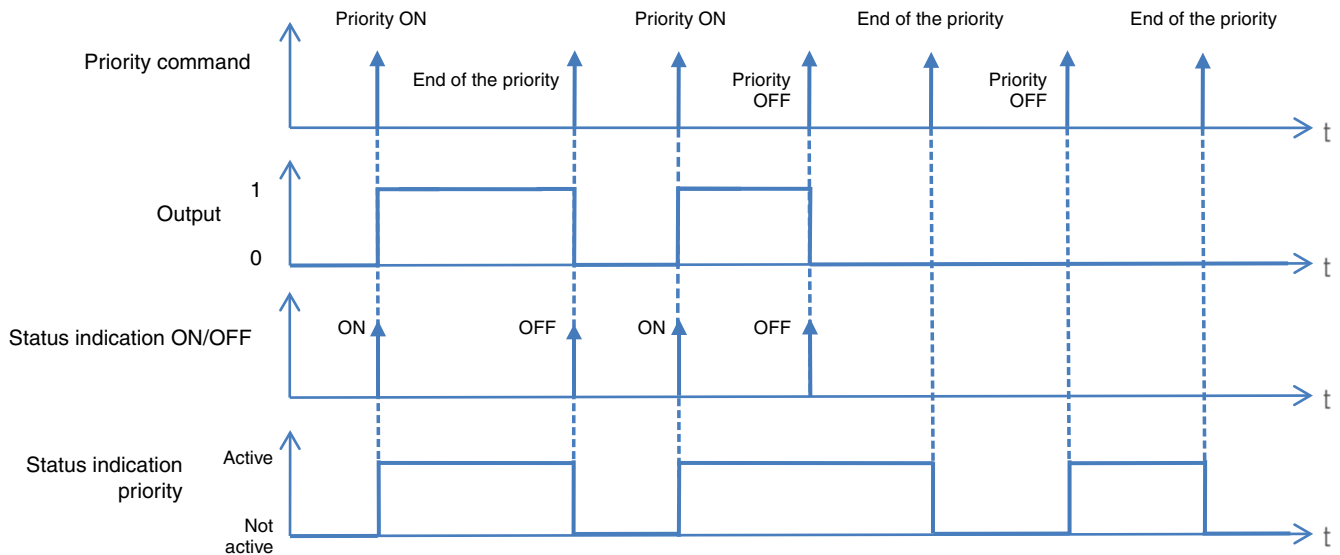

■ Links

- **Priority ON:** Allows forcing and keeping the lighting circuit on.

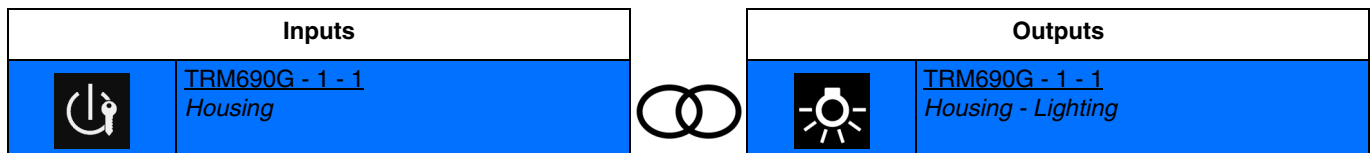

Closing input contact: turn on the light.
Opening input contact: end of the priority.

- **Priority ON push-button:** Allows forcing and keeping the light circuit on using a push-button.

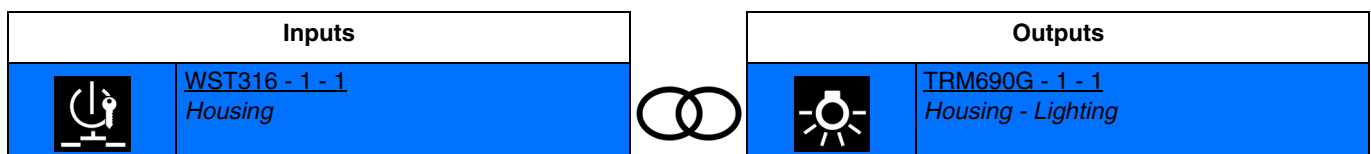

Press on the push-button: turn on the light.
A second press on the push-button cancels the priority.

Note: This function is only available with push-button input products with LEDs indicating status.

- **Priority OFF:** Allows forcing and keeping the lighting circuit off.

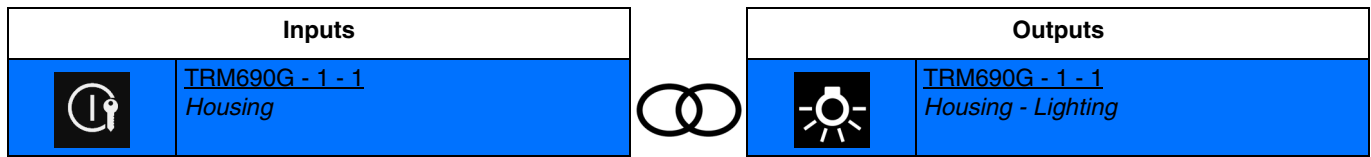

Closing input contact: turns off the light.
 Opening input contact: end of the priority.

- **Priority OFF push-button:** Allows forcing and keeping the lighting circuit off using a push-button.

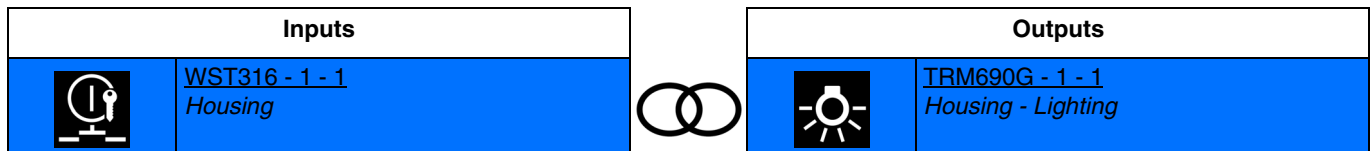

Press on the push-button: turns off the light.
 A second press on the push-button cancels the priority.

Note: This function is only available with push-button input products with LEDs indicating status.

4.3.4 Automatic control

The Automatic control function is used to command an output in parallel to the ON/OFF function. The two functions have the same level of priority. The last command received will act on the status of the output. An additional command object is used to activate or deactivate the Automatic control.

Example: when an output is controlled by a button and in parallel by an automatic control (timer, twilight switch, weather station, etc.) the automatic control can be deactivated for reasons of comfort (vacations, public holidays, etc.).

Operating principle:

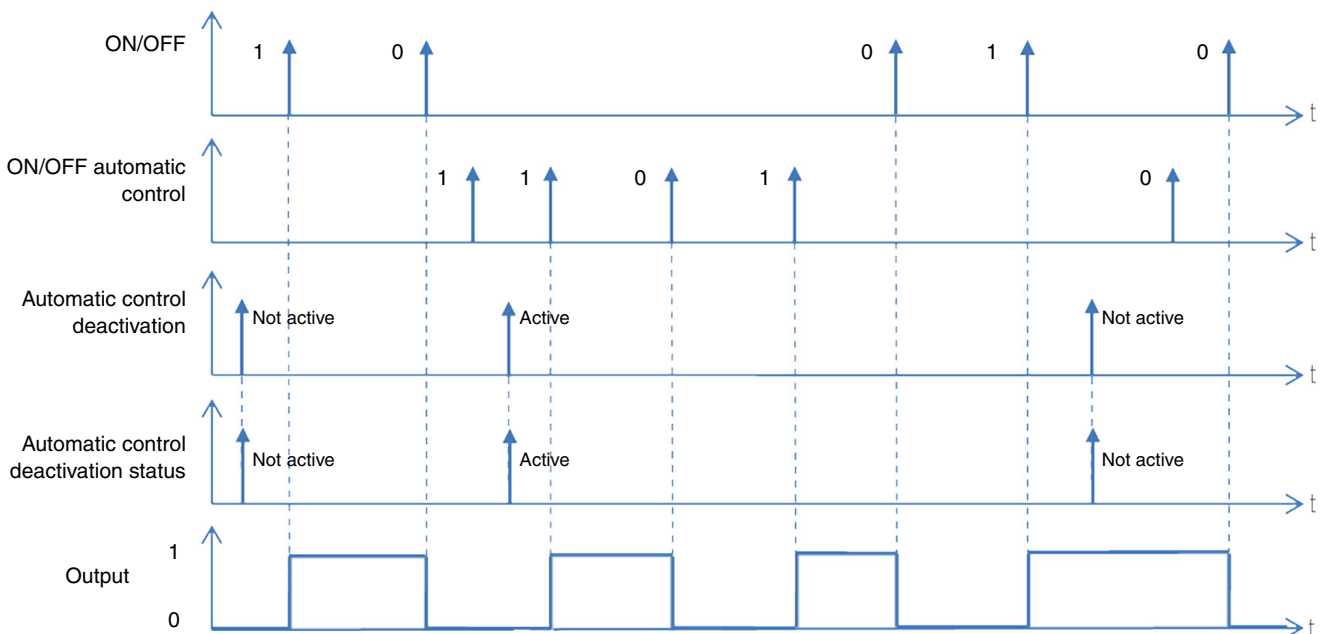

■ Links

- **Automatic control ON:** Allows turning on the light circuit using Automatic control.

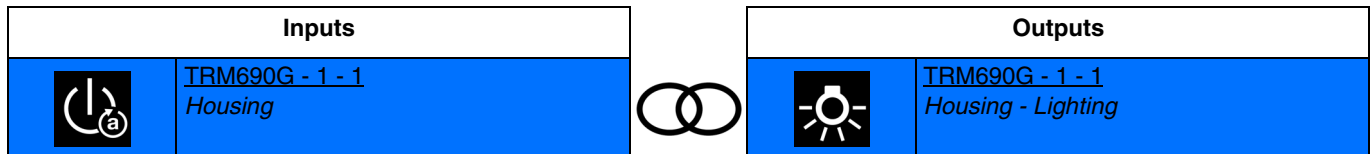

Closing input contact: turn on the light.
Opening input contact: no action.

- **Automatic control OFF:** Allows switching off the light circuit using automatic control.

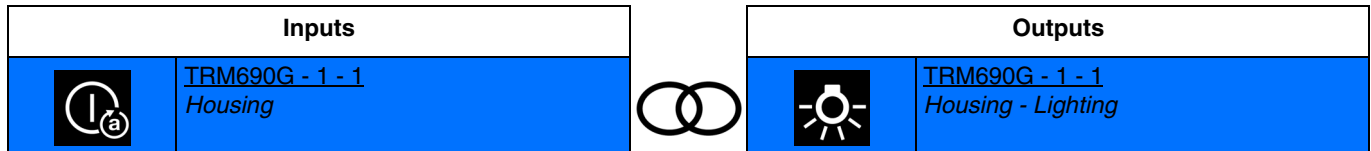

Closing input contact: turns off the light.
Opening input contact: no action.

- **ON/OFF automatic control:** Allows turning the lighting circuit on or off using Automatic control (Switch).

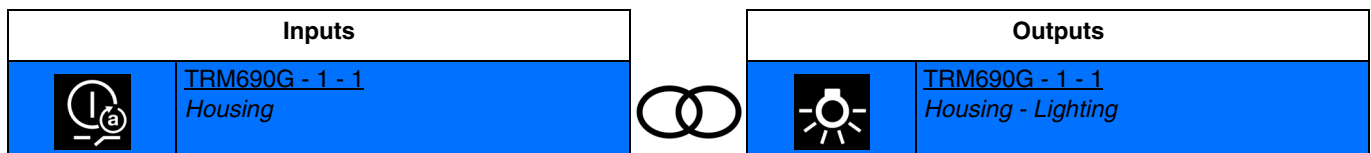

Closing input contact: turns on the light at the last saved level.
Opening input contact: turns off the light.

- **Automatic control deactivation:** Deactivates automatic control.

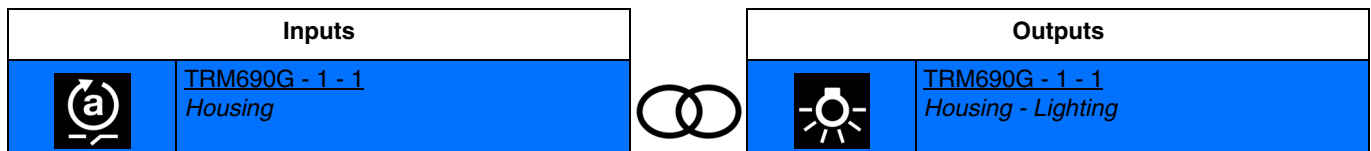

Closing input contact: deactivated automatic control.
Opening input contact: activated automatic control.

- **Deactivation Automatic control push-button:** Deactivates Automatic control using a push-button.

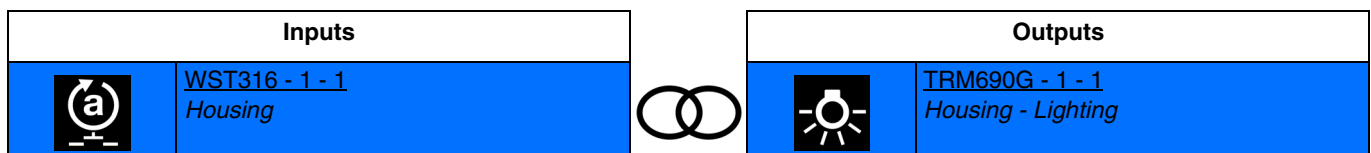

Press on the push-button: deactivated automatic control.
A second press on the push-button activates the automatic control.

Note: This function is only available with push-button input products with LEDs indicating status.

4.3.5 Load shedding

The Load shedding function is used to force an output to OFF.

Priority: **Load shedding** > Priority > Basic function.

This command has the highest priority. No other command is taken into account if the mode is active. The status of the output is memorised but not applied. At the end of load shedding, the output is switched to the theoretical status without Load shedding (memorisation).

Note: The Load shedding function is only available in products TRM693G and TRM694G.

Example: Load shedding function

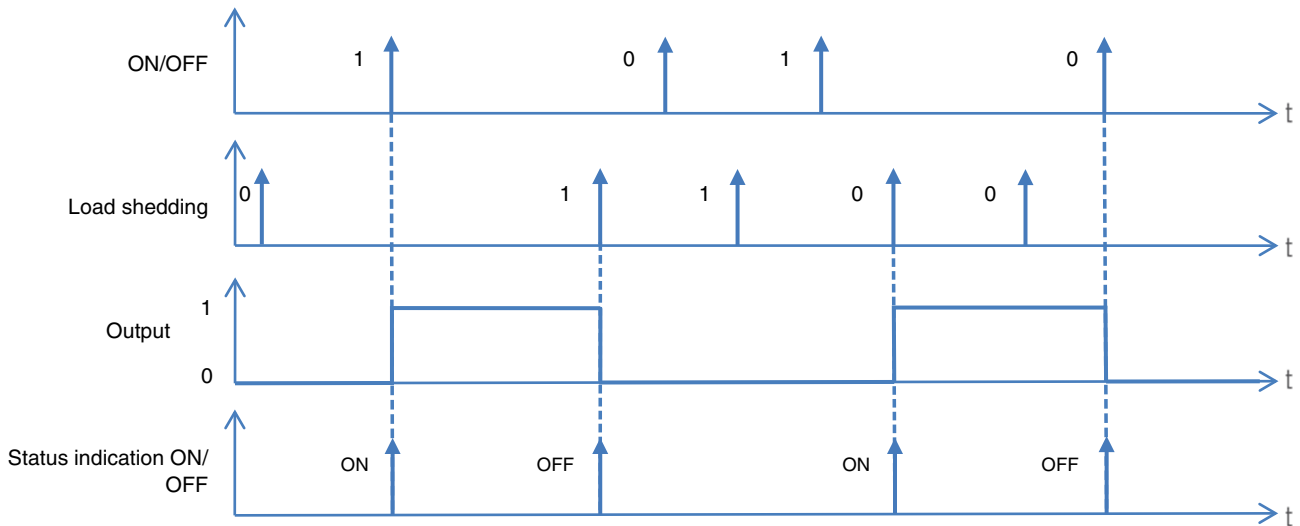

■ Links

- **Load shedding:** Allows forcing an output to OFF.

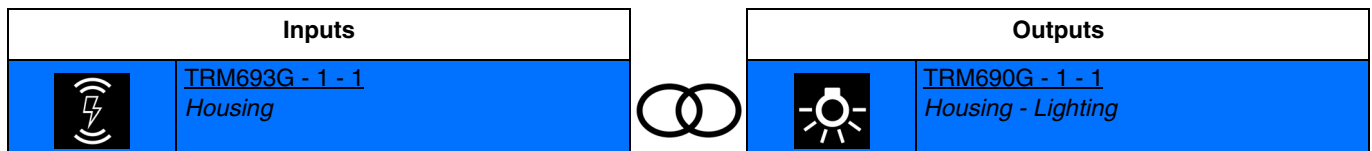

Closing input contact: priority of the output to off.

Opening input contact: return to output status before load shedding (memorisation).

4.3.6 Scene

The Scene function is used to switch groups of outputs into a configurable predefined state. Each output can be included in 8 different scenes.

Operating principle:

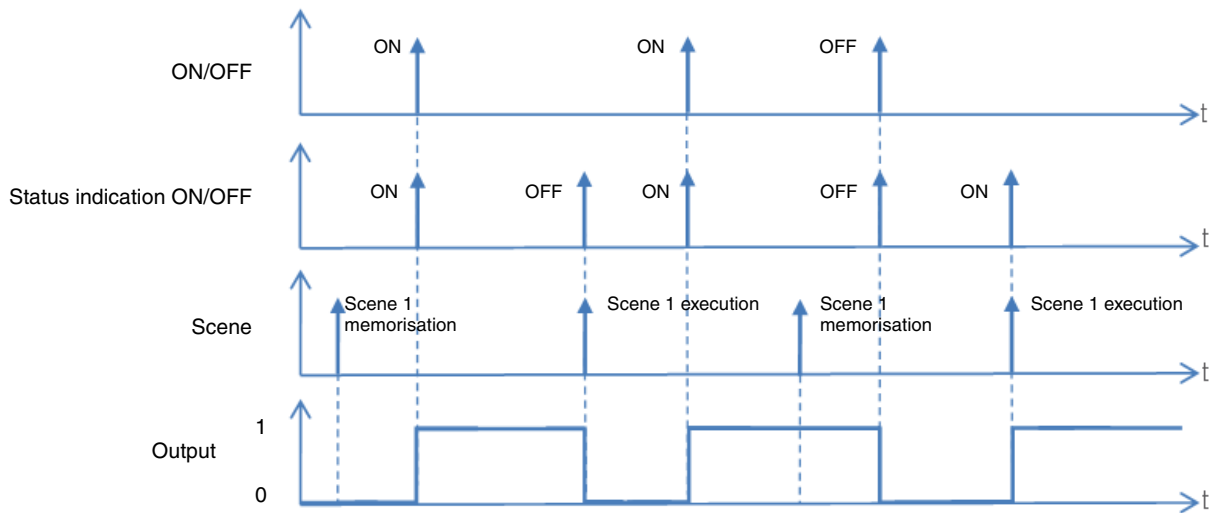

Learning and storing scenes

This process is used to change and store a scene. For example, by locally pressing the key in the room or by emission of the values from a visualization.

To access and store scenes, the following values must be sent:

Scene number	Access scene (Object value: 1 byte)	Store scene (Object value: 1 byte)
1-64	= Scene number - 1	= Scene number + 128
Examples		
1	0	128
2	1	129
3	2	130
...	...	
64	63	191

Here is the scene memorisation for local switches, for example.

- Activate scene by briefly pressing the transmitter that starts it.
- The outputs (lights, shutters, etc.) are set in the desired state using the usual local control devices (buttons, remote control, etc.).
- Memorise the status of the outputs with a press greater than 5 seconds long on the transmitter that starts the scene. The memorisation can be displayed by short-term activation of the outputs.

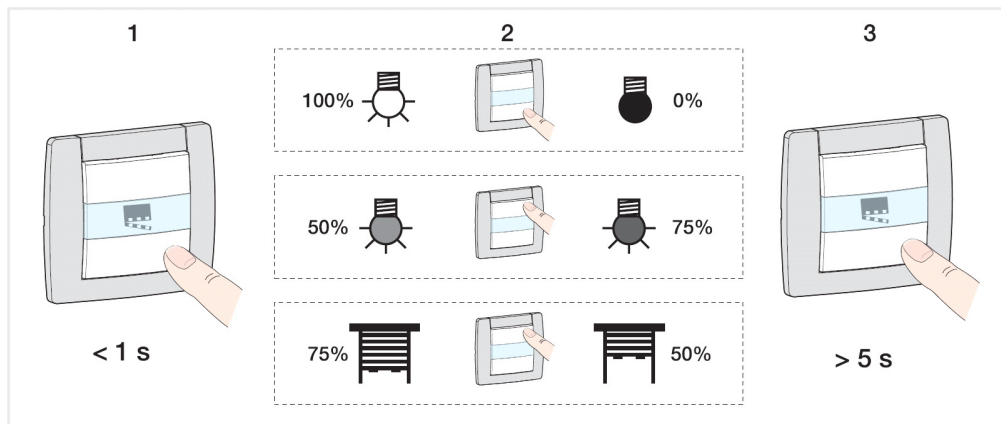

Product learning and memorisation

This procedure allows modifying a scene using a local action on the push buttons located on the front side of the product.

- Activate the scene using a short press on the ambiance push button, which triggers the scene,
- Set the product to manual mode and set the outputs to the desired status by pressing the push-buttons associated with the outputs,
- Return to Auto mode,
- Save the scene using a long push for more than 5 seconds on the push-button that triggers the scene,
- Memorisation is signalled by the inversion of the concerned output status for 3 sec.

■ Links

- **Scene:** The scene is activated by pressing the push-button.

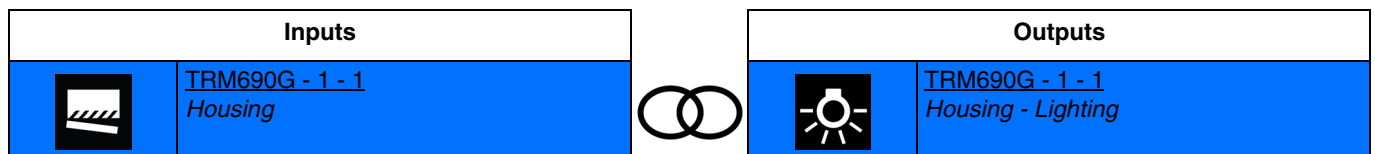

Closing input contact: scene activation.

Opening input contact: no action.

Note: At the time the connection is made, the scene number must be defined for the closing input contact.

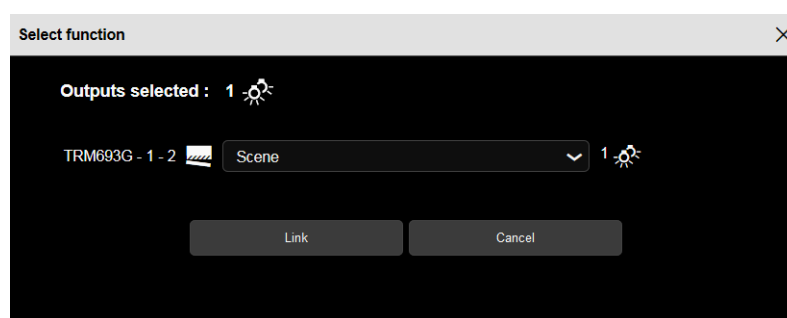

- **Scene switch:** The scene is activated according to the closing or opening input contact.

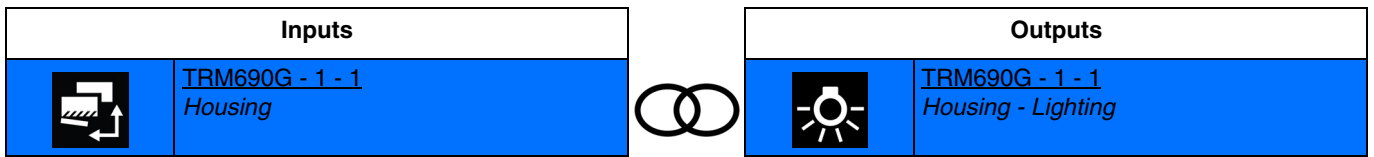

Closing input contact: scene activation 1.
 Opening input contact: scene activation 2.

Note: At the time the connection is made, the scene number must be defined for the closing and opening input contact.

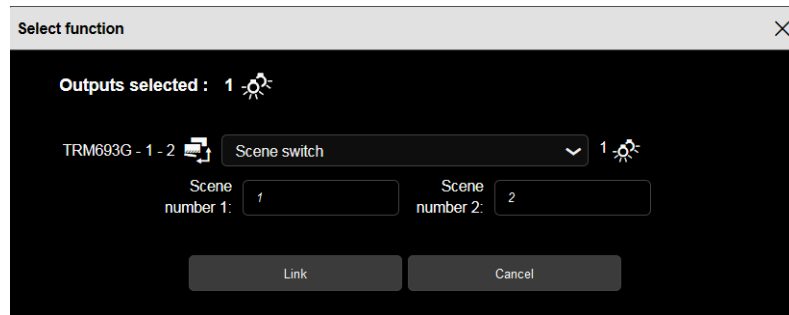

4.4 Input operation mode

4.4.1 Lighting

An output can be switched on or off using the ON/OFF function.

Available functionalities	
ON	Automatic control ON
OFF	Automatic control OFF
ON/OFF	ON/OFF automatic control
Toggle switch	Load shedding
Timer	Scene
Priority ON	Scene switch
Priority OFF	Automatic control deactivation

Note: For the function **Automatic control deactivation**, see: [Automatic control deactivation](#).
For the function **Scene** and **Switch scene**, see: [Scene](#).

- **ON**: Turns on the lighting circuit.

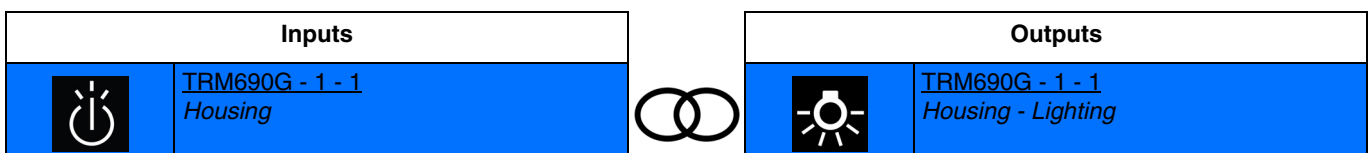

Activation of the input by short presses switches on the light.
Successive activation keeps the light on.

- **OFF**: Turns off the lighting circuit.

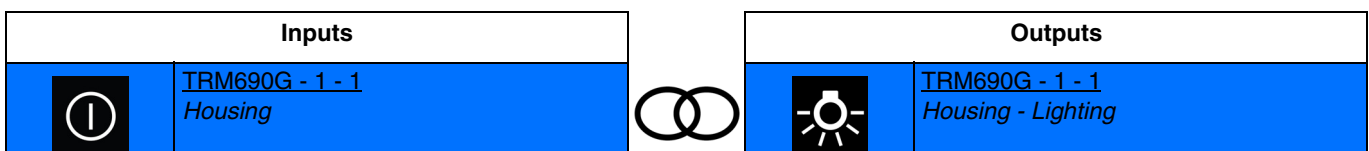

Activating the input switches off the light.
Successive activation keeps the light off.

- **ON/OFF:** Turns on or shuts off the lighting circuit (Switch).

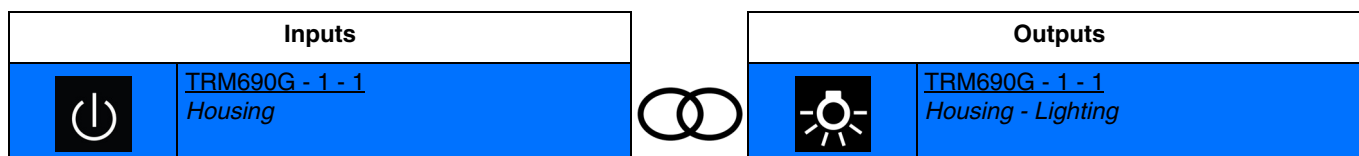

Closing the input contact switches on the light.
Opening the input contact switches off the light.

*Note: By default, the input operates like an NO contact (Normally open). If the parameter **Inverted** is validated, the input operates like an NC contact (Normally closed).*

Below are the outputs which can also have these functions:

	Dimming	Controls the dimming output for switching the light on and off. This procedure enables a same input to be connected to an ON/OFF output and to a dimming output.
	Heating	Controls the output for switching the heating system on and off.
	CMV	Controls the output for switching the CMV system on and off.
	Backlight	Receives status indications from another product for controlling the Backlight.
	Override	Overrides the current operating mode.
	Logical operation	Receives the status of the inputs or outputs of one or more products in order to perform a logical operation for displaying information.

It is also possible to make a link between 2 inputs. Below are the inputs which can also have these functions:

	Domestic Hot Water (DHW) control	Enables the control of a DHW boiler.
	Increase/decrease dimming	Controls the dimming input for switching the light on and off (Only with TX511 and TXC511).

4.4.1.1 Toggle switch

This function enables a lighting circuit or any other load to be commanded to switch on or off. Each time the push-button is pressed the output status is inverted.

Operating principle:

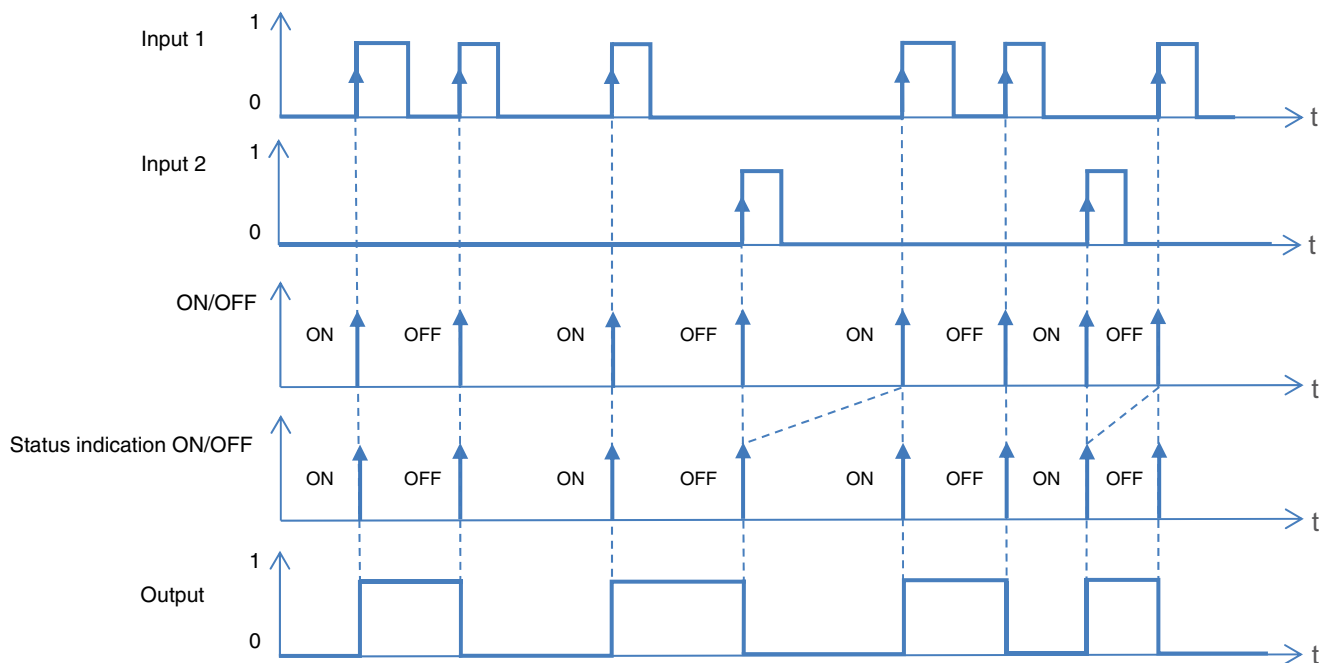

- **Toggle switch:** Inverses the lighting circuit status.

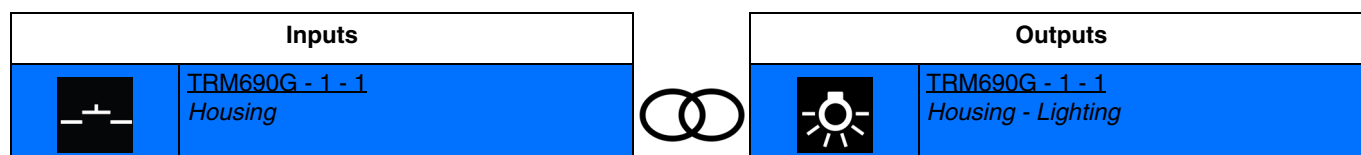

Activating the input by a short press switches between on and off. Successive activation inverts the output contact status each time.

Below are the outputs which can also have these functions:

	Dimming	Controls the dimming output for switching the light on and off. This procedure enables a same input to be connected to an ON/OFF output and to a dimming output.
	Heating	Controls the output for switching the heating system on and off.
	CMV	Controls the output for switching the CMV system on and off.
	Backlight	Receives status indications from another product for controlling the Backlight.
	Override	Overrides the current operating mode.
	Logical operation	Receives the status of the inputs or outputs of one or more products in order to perform a logical operation for displaying information.

It is also possible to make a link between 2 inputs. Below are the inputs which can also have these functions:

	Domestic Hot Water (DHW) control	Enables the control of a DHW boiler.
	Increase/decrease dimming	Controls the dimming output for switching the light on and off (Only with TX511 and TXC511).

4.4.1.2 Timer

The Timer function can switch a lighting circuit on or off for a configurable period. A short press on the push-button re-launches the timer. The timer can be interrupted before the end of the time by a long press.

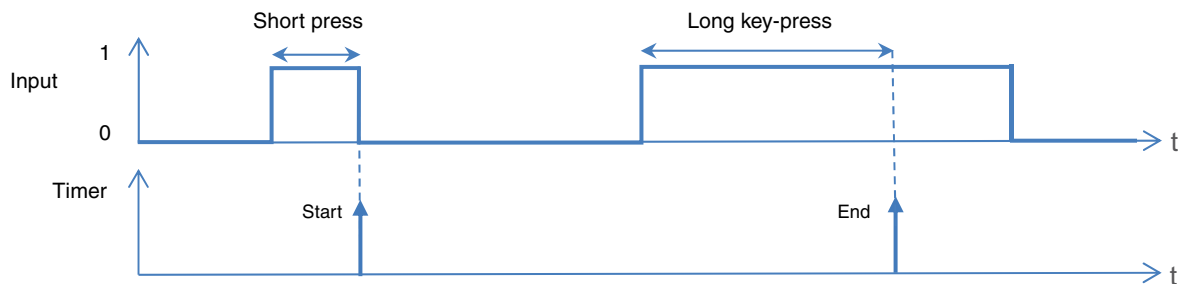

The Timer function is used to switch on a lighting circuit for a programmable period.

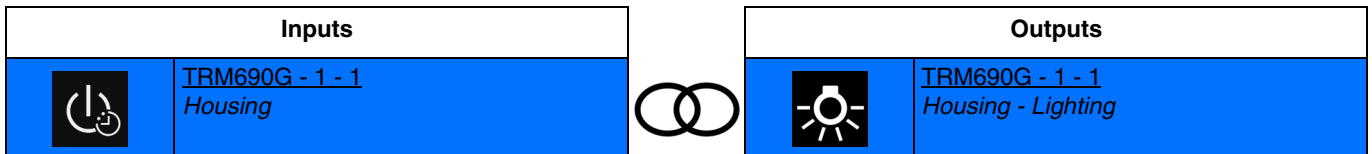

Activating the input by a short press <1 s switches on the light for a length of time.

Timing function interruption:

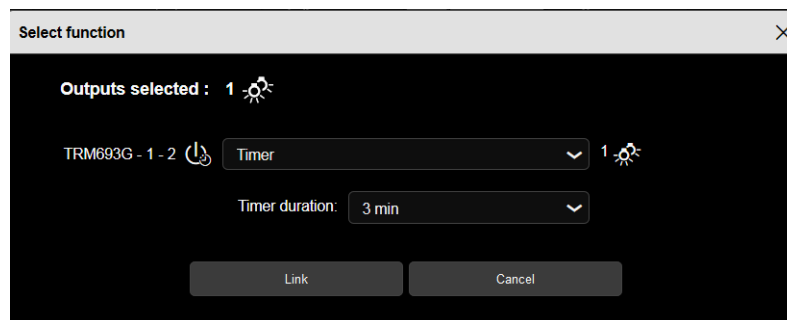

Activating the input with a long press >1 s stops timing function mid way and switches off (OFF).

Note: At the time of connection, it is possible to define the timer duration. This duration is defined on the output product.



*Note: By default, the input operates like an NO contact (Normally open). If the parameter **Inverted** is validated, the input operates like an NC contact (Normally closed).*

Below are the outputs which can also have these functions:

	Dimming	Controls the dimming output for switching on the light to the last level memorised for a programmable duration.
	CMV	Controls the output for switching on the CMV system for a programmable duration.

4.4.1.3 Priority

The Priority function is used to force the output into a defined state.
 This function the priority or priority cancellation controls to be issued.
 No other command is taken into account when the Priority is active. Only priority or alarm cancellation commands will be taken into account.

- **Priority ON:** Allows forcing and keeping the lighting circuit on.

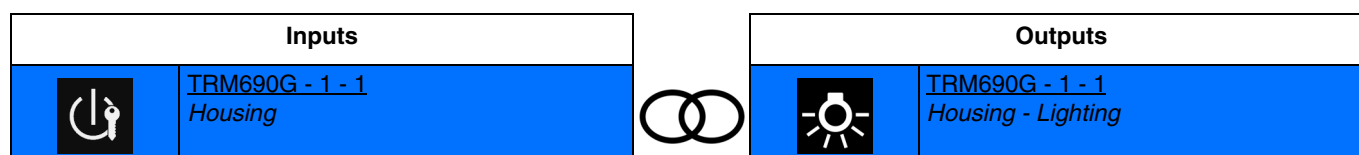

Activating the input forces the output to ON.
 Successive activation switches between ON priority and priority cancellation.

- **Priority OFF:** Allows forcing and keeping the lighting circuit off.

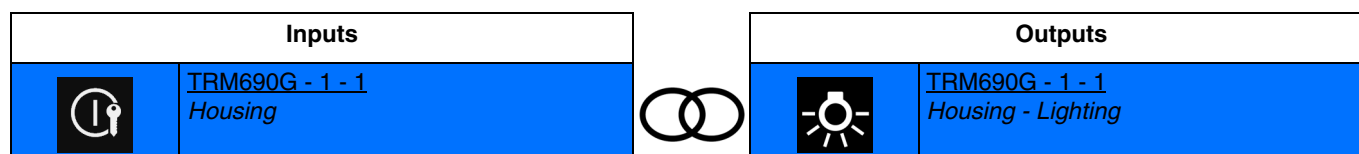

Activating the input forces the output to OFF.
 Successive activation switches between OFF priority and priority cancellation.

Below are the outputs which can also have these functions:

	Dimming	Forces and keeps the lighting circuit on or off.
---	---------	--

It is also possible to make a link between 2 inputs. Below are the inputs which can also have these functions:

	Increase/decrease dimming	Controls the dimming input for switching the light on and off (Only with TX511 and TXC511).
---	---------------------------	---

4.4.1.4 ON/OFF Automatic control

The Automatic control function enables an output to be controlled in parallel to the standard control. An additional command object (Automatic control deactivation) is used to activate or deactivate Automatic control.

- **Automatic control ON:** Allows turning on the light circuit using Automatic control.

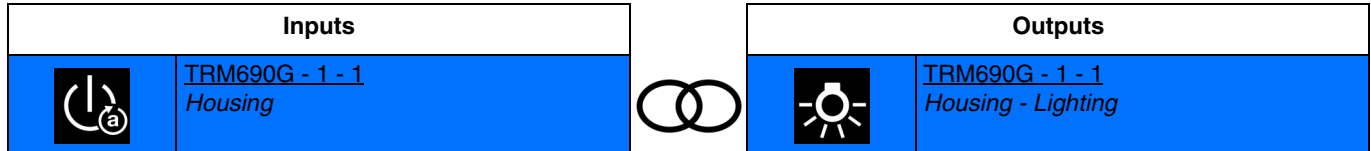

Activation of the input by short presses switches on the light.
Successive activation keeps the light on.

- **Automatic control OFF:** Allows switching off the light circuit using automatic control.

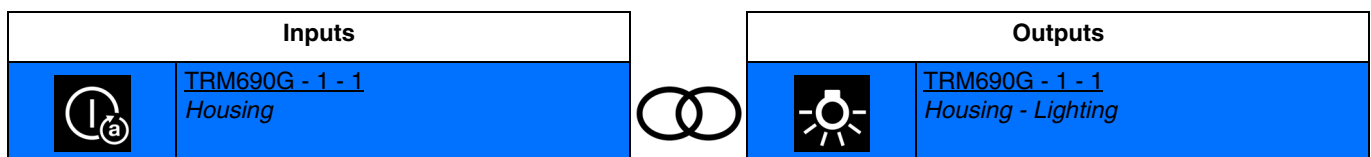

Activating the input switches off the light.
Successive activation keeps the light off.

- **ON/OFF automatic control:** Allows turning the lighting circuit on or off using Automatic control (Switch).

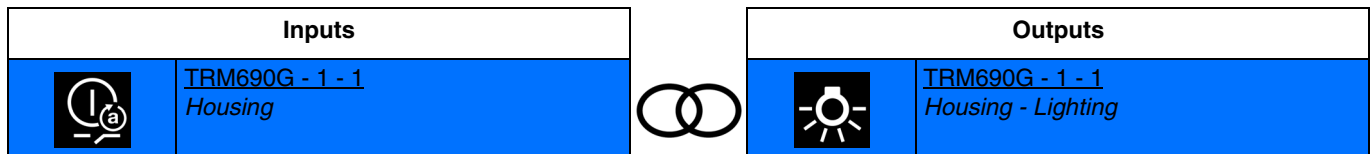

Closing the input contact switches on the light.
Opening the input contact switches off the light.

Below are the outputs which can also have these functions:

	Dimming	Controls the dimming output for switching the light on and off. This procedure enables a same input to be connected to an ON/OFF output and to a dimming output.
---	---------	--

*Note: By default, the input operates like an NO contact (Normally open). If the parameter **Inverted** is validated, the input operates like an NC contact (Normally closed).*

*Note: For the function **Automatic control deactivation**, see: [Automatic control deactivation](#).*

4.4.1.5 Load shedding

The Load shedding function is used to force an output to OFF. At the end of load shedding, the output is switched to the theoretical status without Load shedding (memorisation).

- **Load shedding:** Allows forcing an output to OFF.

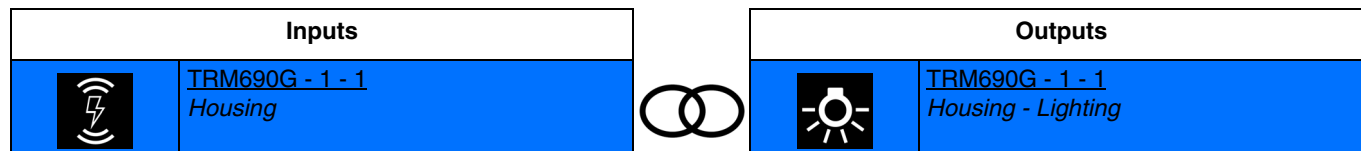

Activating the input forces the output to OFF.

Below are the outputs which can also have these functions:

	Dimming	Controls the dimming output switching off the light. This procedure enables a same input to be connected to an ON/OFF output and to a dimming output.
--	---------	---

*Note: By default, the input operates like an NO contact (Normally open). If the parameter **Inverted** is validated, the input operates like an NC contact (Normally closed).*

4.4.2 Relative or absolute dimming (Brightness value)

With relative dimming, the brightness value is raised or lowered with respect to the current brightness value. This is achieved, for example, by a long press on a sensor button. With absolute dimming, the brightness value to be achieved is set on the dimmer as a % value.

Available functionalities			
	Increase dimming/ON		Dimming automatic control PB
	Decrease dimming/OFF		Dimmer switch automatic control
	Increase/decrease dimming		Scene
	Dimming		Scene switch
	Dimming switch		Automatic control deactivation

*Note: For the function **Automatic control deactivation**, see: [Automatic control deactivation](#).
For the function **Scene** and **Switch scene**, see: [Scene](#).*

4.4.2.1 Dimming

- **Increase dimming/ON:** Increases the output level.

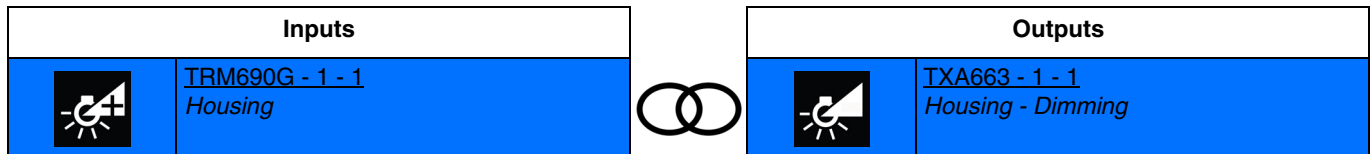

Activating the input by short presses switches on the light to the last level memorised.
Activating the input by long press increases the level of brightness.

- **Decrease dimming/OFF:** Decreases the output level.

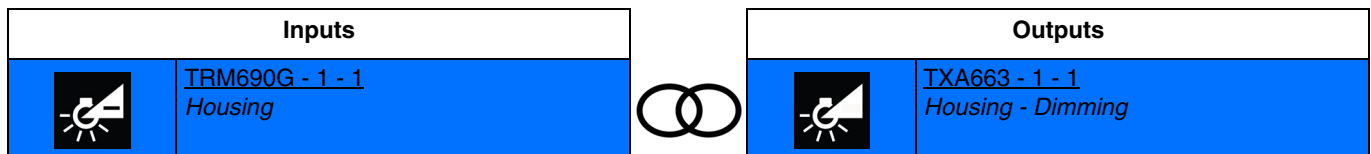

Activating the input by a short press switches off the light.
Activating the input by a long press decreases the level of brightness.

- **Increase/decrease dimming:** Varies the light with a single push-button.

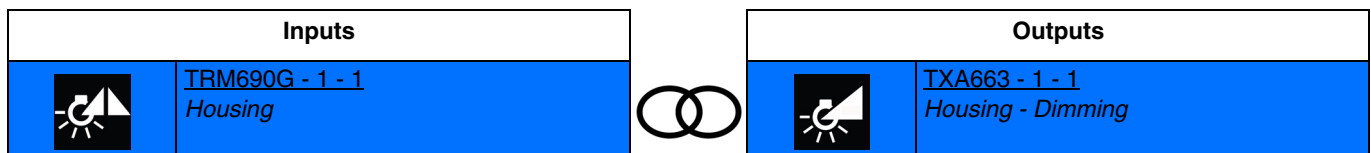

Activating the input by a short press switches between Switching the light on to the last level memorised and Switching the light off.
Activating the input by a long press increases or decreases the level of brightness.

Below are the outputs which can also have these functions:

	Lighting	Controls the ON/OFF output for switching the light on and off. This procedure enables a same input to be connected to an ON/OFF output and to a dimming output.
---	----------	---

It is also possible to make a link between 2 inputs. Below are the inputs which can also have these functions:

	Increase/decrease dimming	Controls the dimming input for dimming the light (Only with TX511 and TXC511).
---	---------------------------	--

- **Dimming:** Varies the light with a defined brightness value.

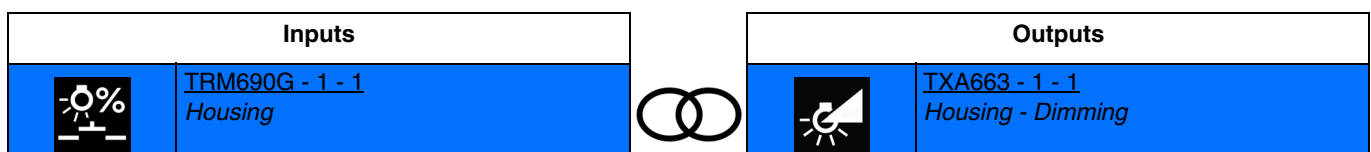

Activating the input switches the light on to the brightness value defined.

Note: At the time the connection is made, the brightness value must be defined for the contact closure input.

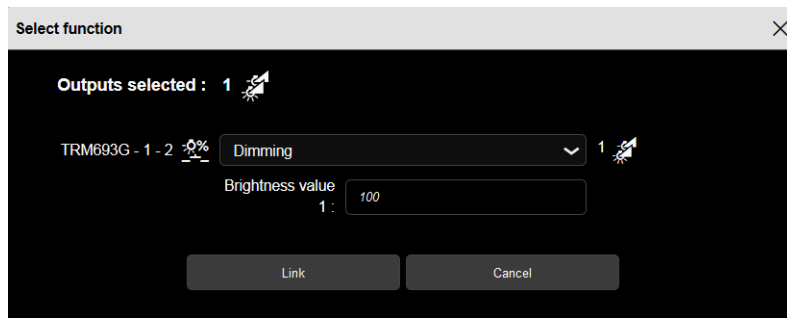

- **Dimming switch:** Varies the light with two brightness values defined according to the opening and closing of the input contact.

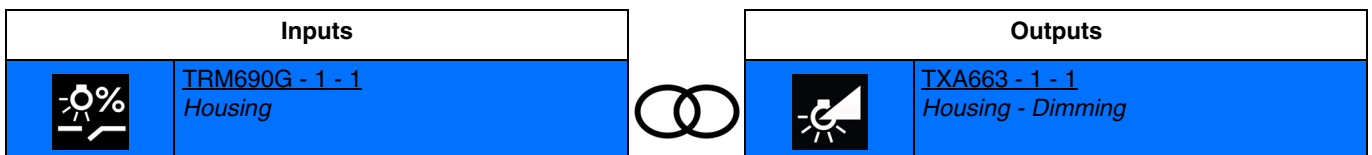

Closing input contact: turns on the light at the 1 brightness value.
 Opening input contact: turns on the light at the 2 brightness value.

Note: At the time the connection is made, the brightness values must be defined for the contact closure input.

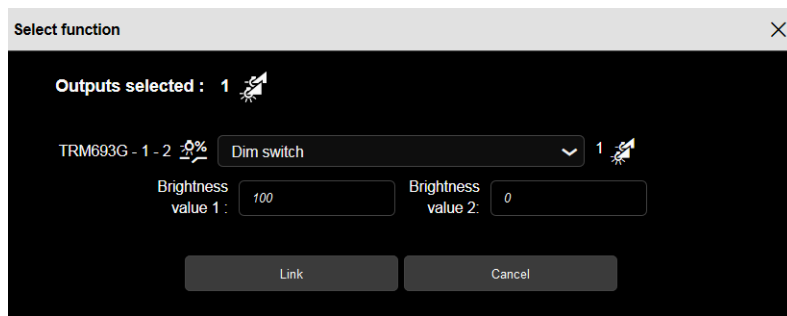

4.4.2.2 Dimming automatic control

- **Dimming automatic control PB:** Allows varying the light with a defined brightness value using Automatic control.

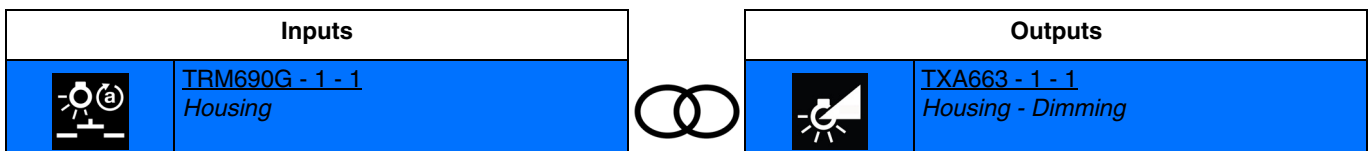

Activating the input switches the light on to the brightness value defined.

Note: At the time the connection is made, the brightness value must be defined for the contact closure input.

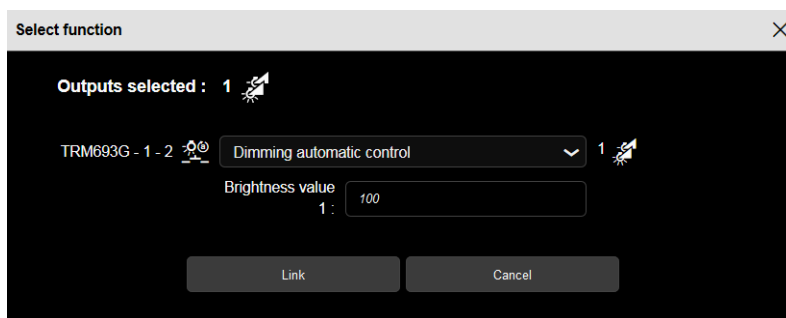

- **Dimmer switch automatic control:** allows varying the light with two defined brightness values according to the opening and closing input contact using automatic control.

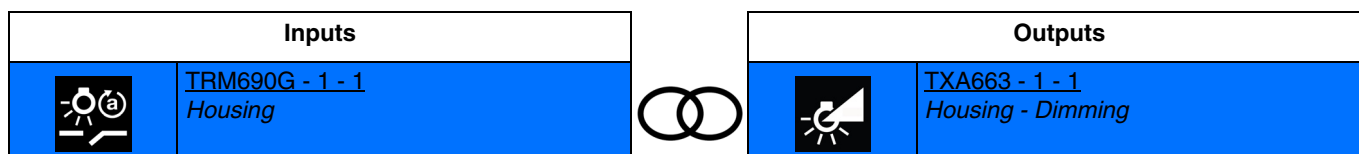

Closing input contact: turns on the light at the 1 brightness value.
 Opening input contact: turns on the light at the 2 brightness value.

Note: At the time the connection is made, the brightness values must be defined for the contact closure input.

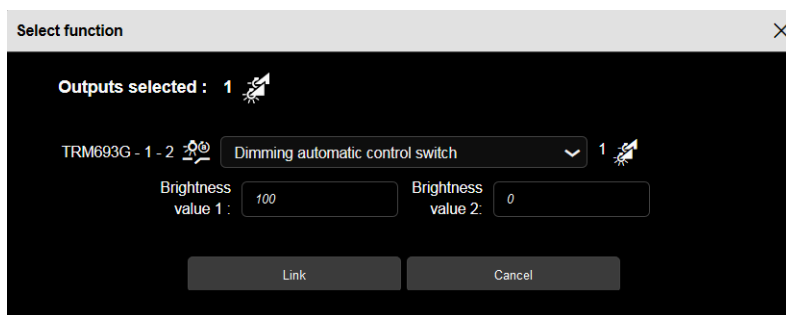

*Note: For the function **Automatic control deactivation**, see: [Automatic control deactivation](#).*

4.4.3 Shutter/blind

Available functionalities			
	Blinds up		Priority up
	Blinds down		Priority down
	Shutter UP		Wind alarm
	Shutter DOWN		Rain alarm
	Up/down		Automatic control shutter angle
	Down/up		Automatic control slat angle
	Switch up		Automatic control shutter and slat angle
	Down switch		Automatic control shutter position switch
	Up/stop		Automatic control inter slat angle
	Down/stop		Automatic control inter shutter and slat angle
	Shutter position		Scene
	Slat angle		Scene switch
	Shutter and slat angle		Automatic control deactivation
	Shutter angle switch		
	Slat angle switch		
	Shutter and slat angle switch		

Note: For the function **Automatic control deactivation**, see: [Automatic control deactivation](#).
 For the function **Scene** and **Switch scene**, see: [Scene](#).

4.4.3.1 Up/down

- **Blinds up:** Allows to raise or stop a blind or tilt the blind slats.

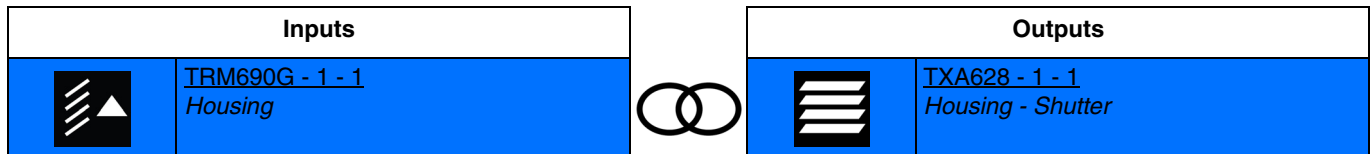

Activating the input by a short press briefly closes the Up output contact (function direction of a blind's slats).
 Activating the input by a long press closes the Up output contact for a length of time (function raising a rolling shutter or a blind).

Note: If a brief input contact occurs during the delay, the output contact opens (stop function).

- **Blinds down:** Allows to lower or stop a blind or tilt the blind blades.

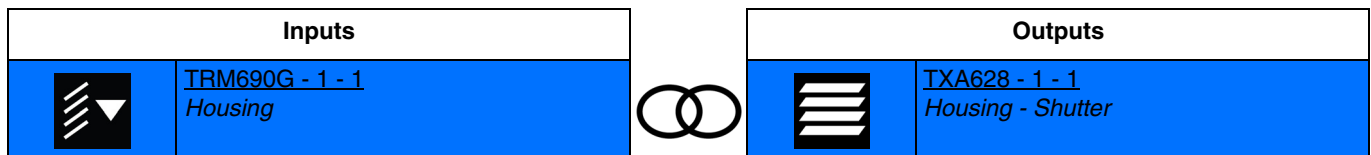

Activating the input by a short press briefly closes the Down output contact (function direction of a blind's slats).
 Activating the input by a long press closes the Down output contact for a length of time (function lowering a rolling shutter or a blind).

Note: If a brief input contact occurs during the delay, the output contact opens (stop function).

- **Shutter UP:** Allows to raise or stop a rolling shutter.

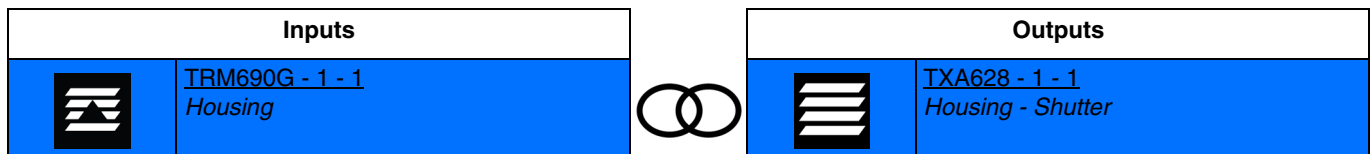

Activating the input closes the Up output contact for a length of time (function raising a rolling shutter or a blind).

Note: If a brief input contact occurs during the delay, the output contact opens (stop function).

- **Shutter DOWN:** Allows to lower or stop a rolling shutter.

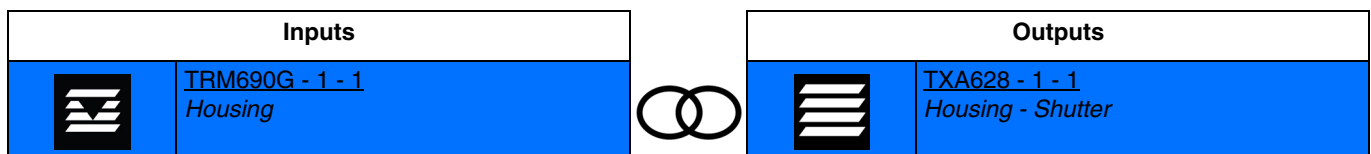

Activating the input closes the Down output contact for a length of time (Function Lowering a rolling shutter or a blind).

Note: If a brief input contact occurs during the delay, the output contact opens (stop function).

- **Up/down:** Allows to raise or lower a rolling shutter or a blind using a switch.

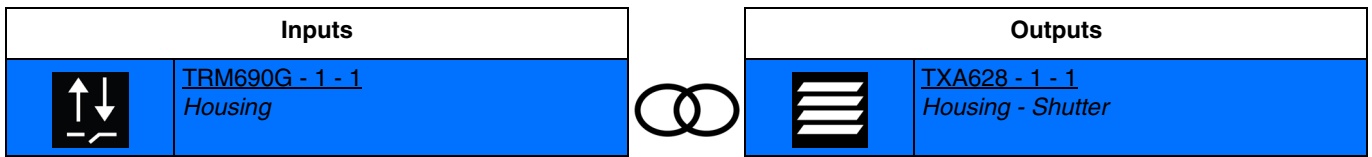

Closing input contact: delayed closing of the raise output contact.
 Opening input contact: delayed closing of the lowering output contact.

- **Down/up:** Allows to raise or lower a rolling shutter or a blind using a switch.

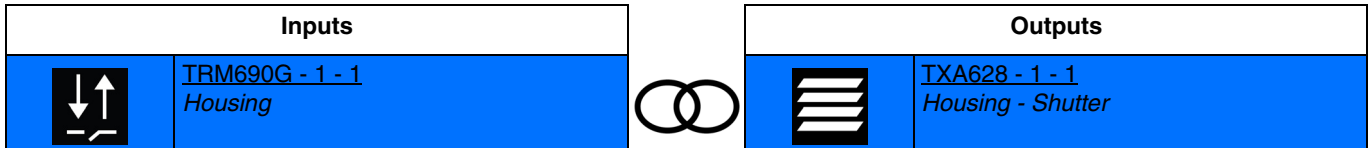

Closing input contact: delayed closing of the lowering output contact.
 Opening input contact: delayed closing of the raise output contact.

- **Switch up:** Allows to raise a rolling shutter or a blind using a switch.

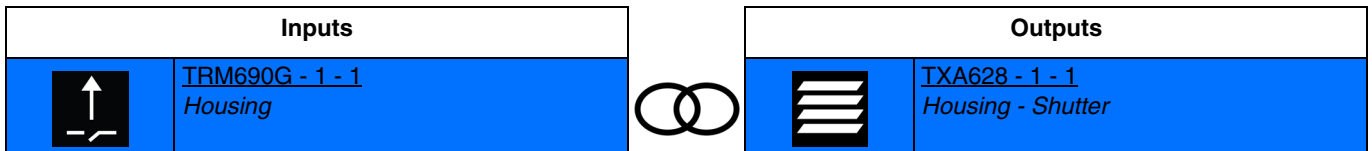

Closing input contact: delayed closing of the raise output contact.
 Opening input contact: no action.

- **Down switch:** Allows to lower a rolling shutter or a blind using a switch.

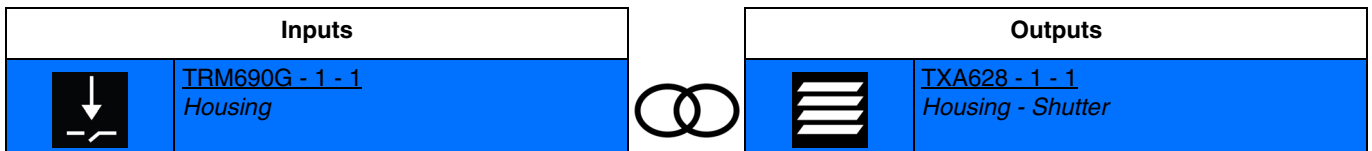

Closing input contact: delayed closing of the lowering output contact.
 Opening input contact: no action.

- **Up/stop:** Allows to raise or stop a rolling shutter or a blind using a switch.

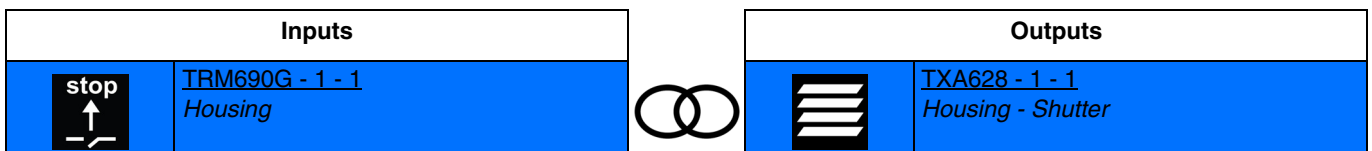

Closing input contact: delayed closing of the raise output contact.
 Opening input contact: opening an output contact (stop function).

- **Down/stop:** Allows to lower or stop a rolling shutter or a blind using a switch.

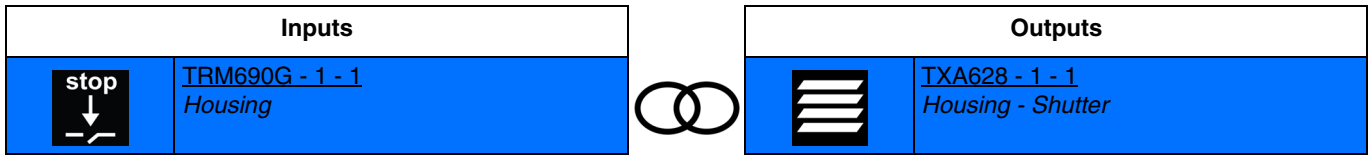

Closing input contact: delayed closing of the lowering output contact.
 Opening input contact: opening an output contact (stop function).

4.4.3.2 Shutter or blind angle

- **Shutter position:** Allows to angle a rolling shutter or blind to the desired height according to a value in %.

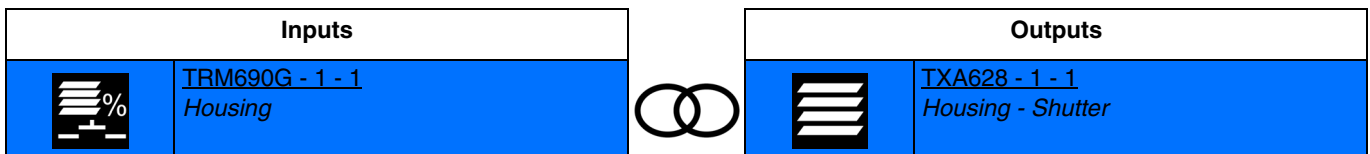

Activating the input closes the output contacts for positioning the shutter or blind for a length of time.

Note: When the connection is made, the value in % of the shutter angle must be defined (0%: upper position, 100%: lower position).

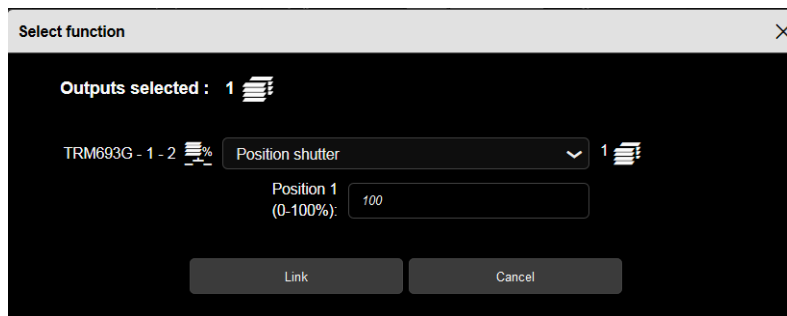

- **Slat angle:** Allows positioning shutter slats according to a value in %.

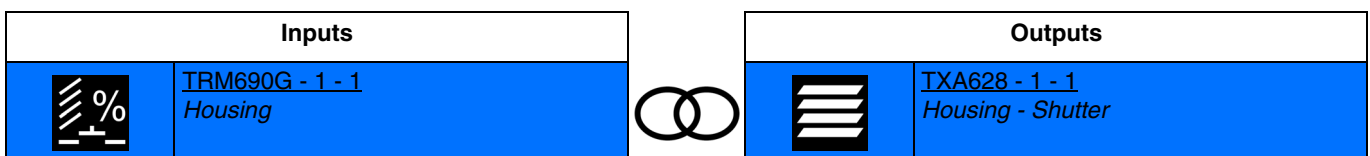

Activating the input closes the output contacts for tilting the blind slats for a length of time.

Note: When the connection is made, the value in % of the shutter slat angle must be defined (0%: slats open, 100%: slats closed).

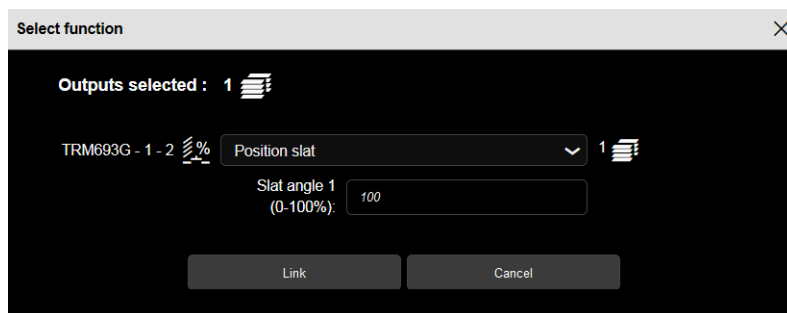

- **Shutter and slat angle:** Allows positioning a rolling shutter or blind at the desired height and the blind slats according to a value in %.

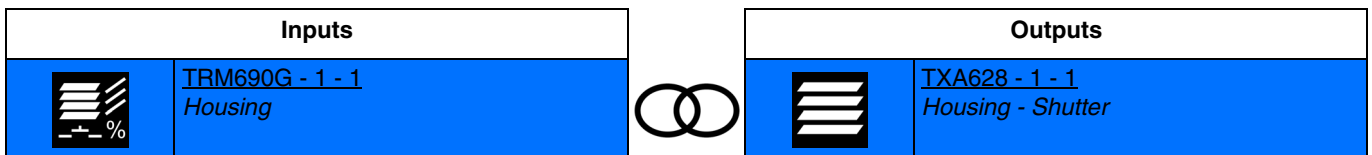

Activating the input closes the output contacts for positioning the shutter or blind and for tilting the blind slats for a length of time.

Note: When the connection is made, the value in % for the shutter position must be defined (0%: high position, 100% low position) and the value in % of the blind slat position (0%: slats open, 100%: slats closed).

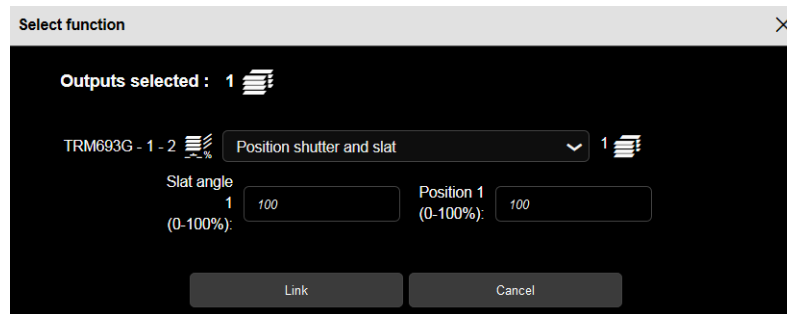

- **Shutter angle switch:** Allows positioning a rolling shutter or blind at the desired height according to a value in % using a switch.

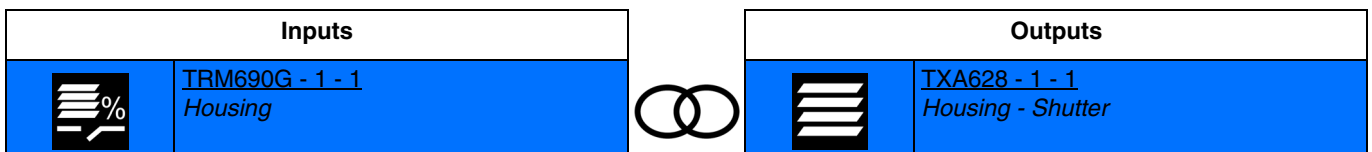

Closing input contact: delayed closing of output contacts for position 1 of the shutter or blind.
 Opening input contact: delayed closing of output contacts for position 2 of the shutter or blind.

Note: When the connection is made, values must be defined in % for shutter positions 1 and 2 (0%: upper position, 100%: lower position).

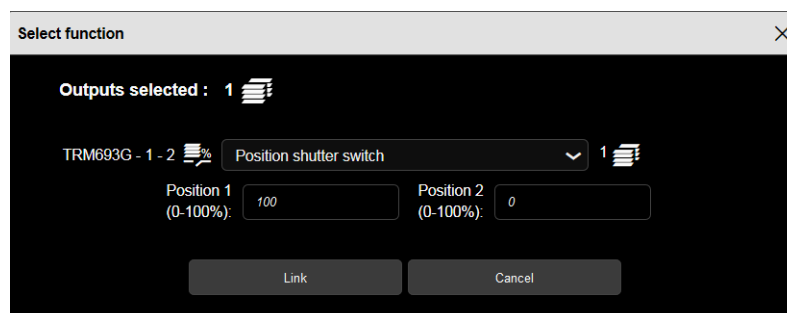

- **Slat angle switch:** Allows positioning blind slates according to a value in % using a switch.

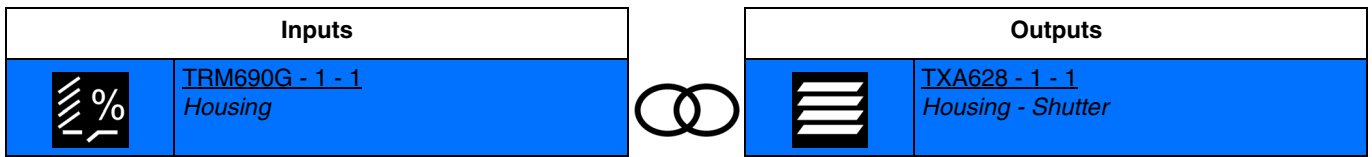

Closing input contact: delayed closing of output contacts for position 1 of the blind slats.
 Opening input contact: delayed closing of output contacts for position 2 of the blind slats.

Note: When the connection is made, values must be defined in % for blind slat positions 1 and 2 (0%: slats open, 100%: slats closed).

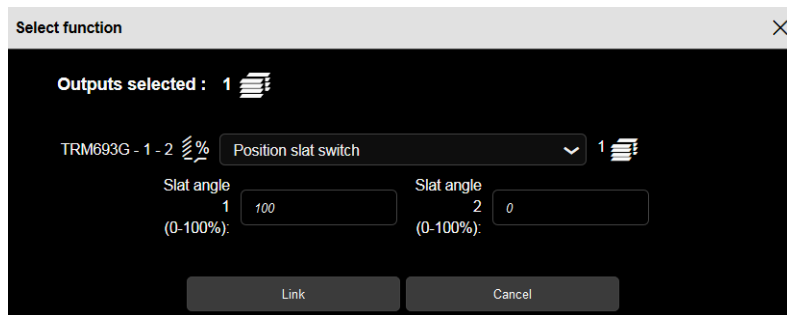

- **Shutter and slat angle switch:** Allows positioning a rolling shutter or a blind at the desired height and the blind slates according to a value in % using a switch.

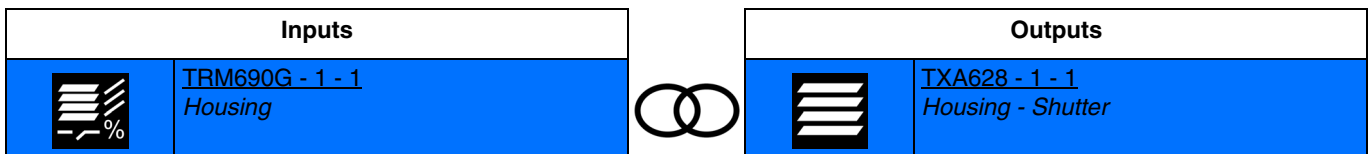

Closing input contact: delayed closing of output contacts for position 1 of the shutter or blind and for position 1 for blind slats.
 Opening input contact: delayed closing of output contacts for position 2 of the shutter or blind and for position 2 for blind slats.

Note: When the connection is made, values must be defined in % for shutter positions 1 and 2 (0%: high position, 100%: low position) and values in % for blind slats positions 1 and 2 (0%: slats open, 100%: slats closed).

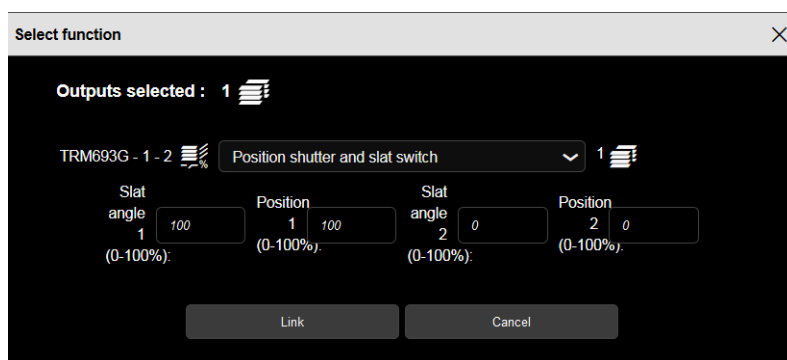

4.4.3.3 Priority

The Priority function forces the control of a shutter.

This function the priority or priority cancellation controls to be issued.

No other command is taken into account when the Priority is active. Only priority or alarm cancellation commands will be taken into account.

- **Priority up:** Allows forcing a rolling shutter or blind to raise.

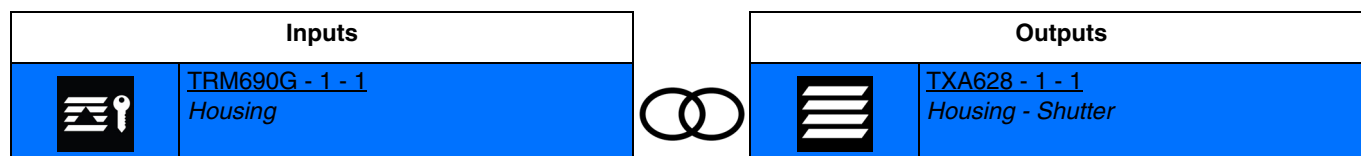

Closing input contact: activation priority and delayed closing of the raise output contact.

Opening input contact: end of the priority.

- **Priority down:** Allowing forcing a rolling shutter or blind to lower.

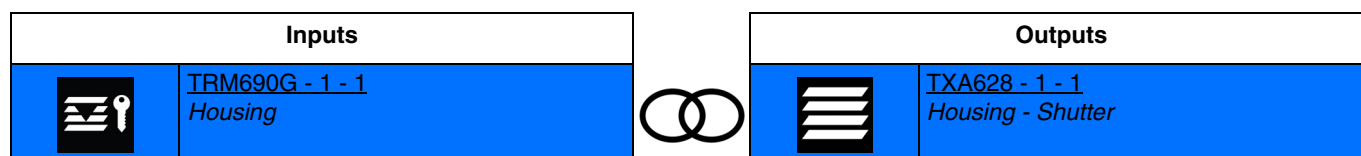

Closing input contact: activation of priority and delayed closing of the lowering output contact.

Opening input contact: end of the priority.

4.4.3.4 Alarm

The Alarm function issues alarms on a cyclical basis to the bus from automations (anemometer, rain detector, twilight switch etc.)

- **Wind alarm:** Allows to set the rolling shutter or blind in a defined position when the alarm is activated.

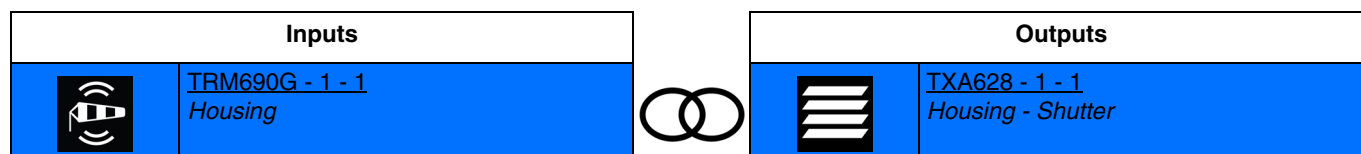

Closing input contact: wind alarm activation.

Opening input contact: alarm end.

The rolling shutter or blind angle is defined through a setting.

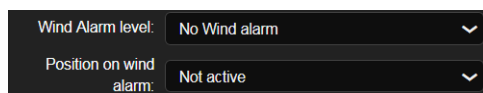

Parameter	Description	Value
Position on wind alarm	During the wind alarm, the shutter/blind output: Not changed Closes the Up contact Closes the down contact	Not active* Up Down

Note: The setting **Wind alarm level** is not taken into account with this type of connection.

* Default value

- **Rain alarm:** Allows to set the rolling shutter or blind in a defined position when the alarm is activated.

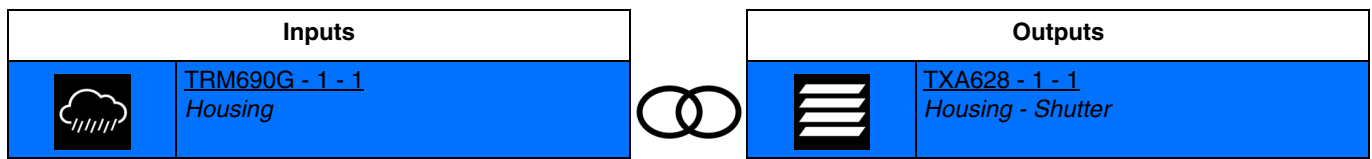

Closing input contact: rain alarm activation.
Opening input contact: alarm end.

The rolling shutter or blind angle is defined through a setting.

Rain Alarm: No ▼

Position on rain alarm: Not active ▼

Parameter	Description	Value
Position on rain alarm	Defines the status of the shutter output on receipt of the rain alarm.	Not active* Up Down

*Note: The setting **rain alarm** is not taken into account with this type of connection.*

4.4.3.5 Shutter/blind automatic control

- **Automatic control shutter angle:** Allows positioning a rolling shutter or blind to the desired height according to a value in % using automatic control.

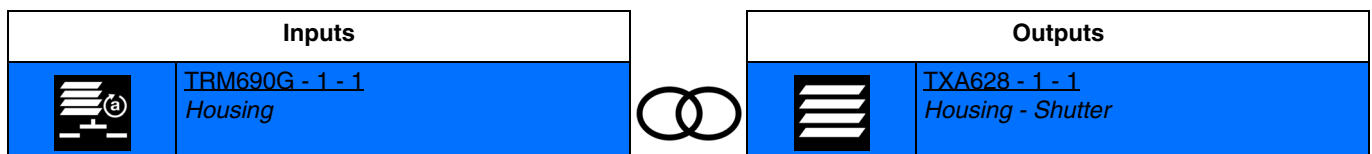

Activating the input closes the output contacts for positioning the shutter or blind for a length of time.

Note: When the connection is made, the value in % of the shutter angle must be defined (0%: upper position, 100%: lower position).

Select function ✕

Outputs selected : 1

TRM693G - 1 - 2 Position shutter automatic control ▼ 1

Position 1 (0-100%):

Link
Cancel

* Default value

- **Automatic control slat angle:** Allows positioning blind slats according to a value in % using automatic control.

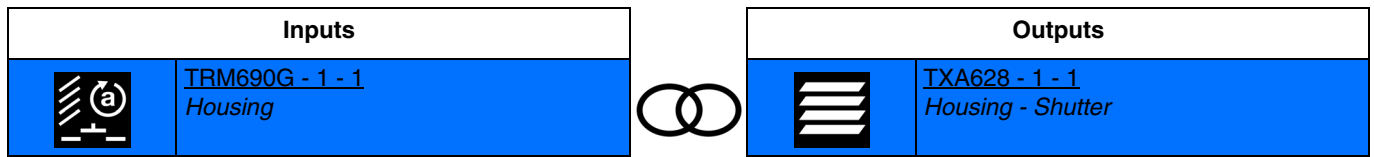

Activating the input closes the output contacts for tilting the blind slats for a length of time.

Note: When the connection is made, the value in % of the shutter slat angle must be defined (0%: slats open, 100%: slats closed).

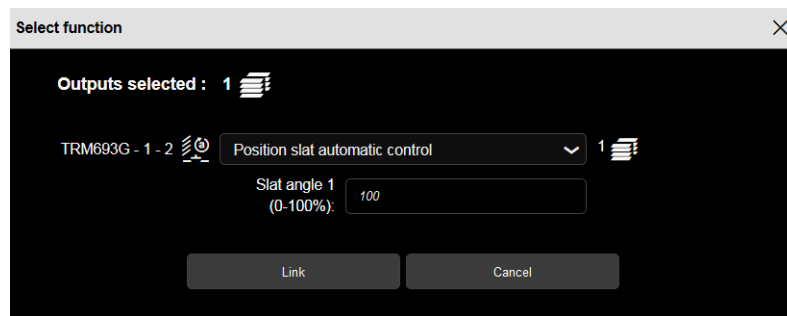

- **Automatic control shutter and slat angle:** Allows positioning a rolling shutter or blind to the desired height and blind slats according to a value in % using automatic control.

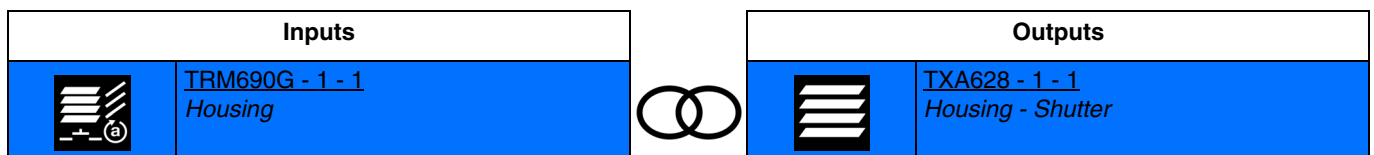

Activating the input closes the output contacts for positioning the shutter or blind and for tilting the blind slats for a length of time.

Note: When the connection is made, the value in % for the shutter position must be defined (0%: high position, 100% low position) and the value in % of the blind slat position (0%: slats open, 100%: slats closed).

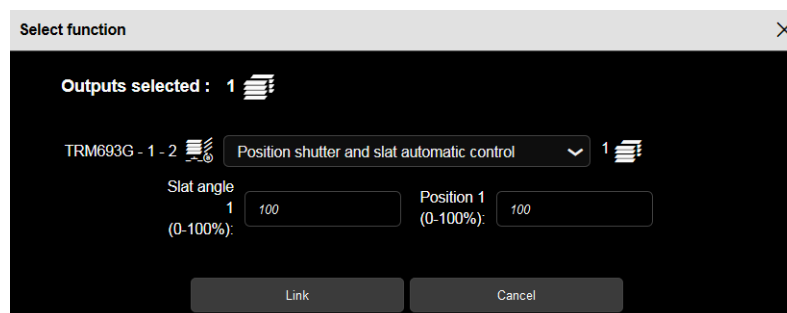

- **Automatic control shutter position switch:** Allows positioning a rolling shutter or blind to the desired height according to a value in % using a switch and automatic control.

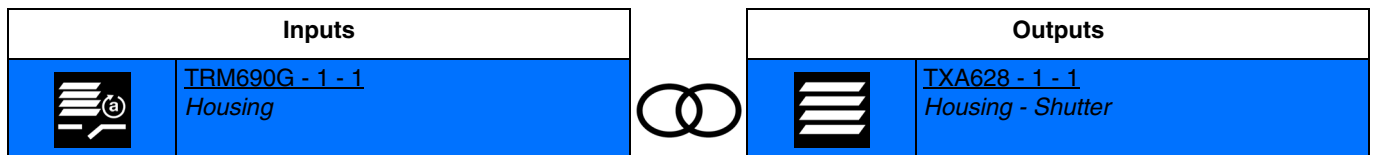

Closing input contact: delayed closing of output contacts for position 1 of the shutter or blind.
 Opening input contact: delayed closing of output contacts for position 2 of the shutter or blind.

Note: When the connection is made, values must be defined in % for shutter positions 1 and 2 (0%: upper position, 100%: lower position).

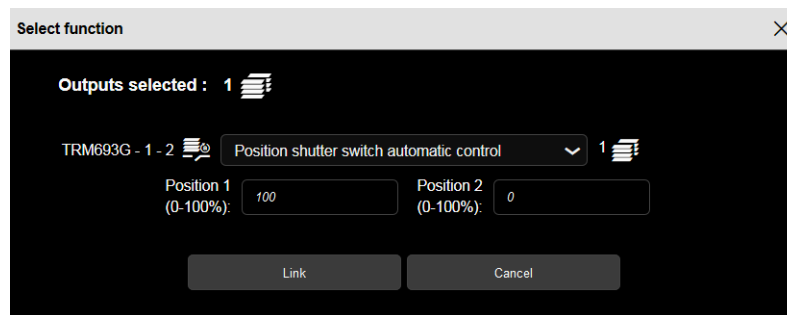

- **Automatic control inter slat angle:** Allows positioning blind slats according to a value in % using a switch and automatic control.

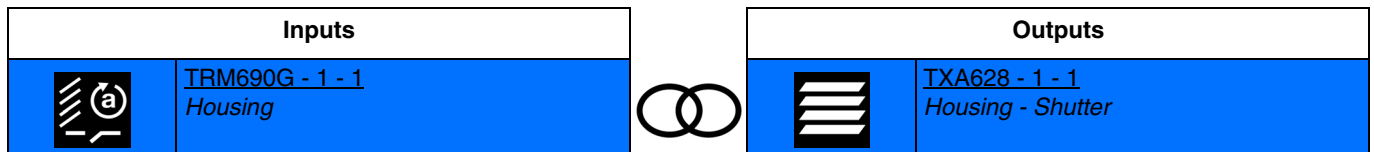

Closing input contact: delayed closing of output contacts for position 1 of the blind slats.
 Opening input contact: delayed closing of output contacts for position 2 of the blind slats.

Note: When the connection is made, values must be defined in % for blind slat positions 1 and 2 (0%: slats open, 100%: slats closed).

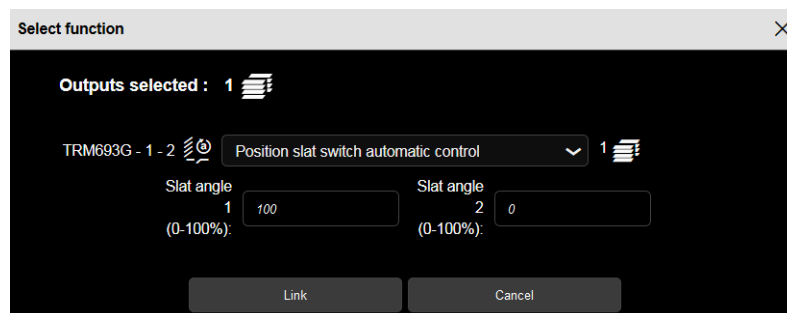

- **Automatic control inter shutter and slat angle:** Allows positioning a rolling shutter or blind to the desired height and blind slats according to a value in % using a switch or automatic control.

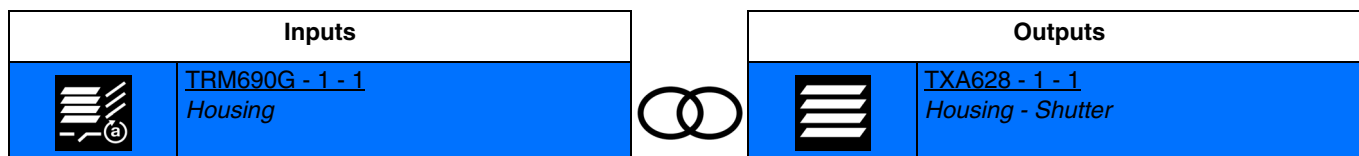





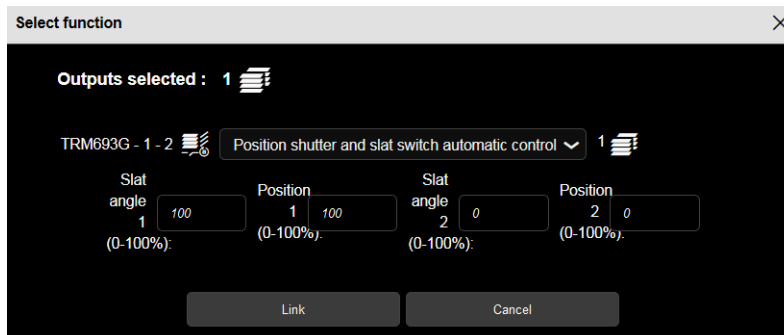











Closing input contact: delayed closing of output contacts for position 1 of the shutter or blind and for position 1 for blind slats.
 Opening input contact: delayed closing of output contacts for position 2 of the shutter or blind and for position 2 for blind slats.

Note: When the connection is made, values must be defined in % for shutter positions 1 and 2 (0%: high position, 100%: low position) and values in % for blind slats positions 1 and 2 (0%: slats open, 100%: slats closed).



4.4.4 Heating/Cooling

Available functionalities			
	Comfort mode		Comfort mode automatic control
	Eco mode		Eco mode automatic control
	Standby mode		Standby mode automatic control
	Protection mode		Protection mode automatic control
	Switch mode		Switch mode automatic control
	Heating/Cooling		Automatic control deactivation
	Comfort priority		Scene
	Protection priority		Scene switch

Note: For the function **Automatic control deactivation**, see: [Automatic control deactivation](#).
 For the function **Scene** and **Switch scene**, see: [Scene](#).

4.4.4.1 Setpoint selection

The heating command operates according to a heating instruction.

- **Comfort mode:** Activates Comfort mode for the heating.

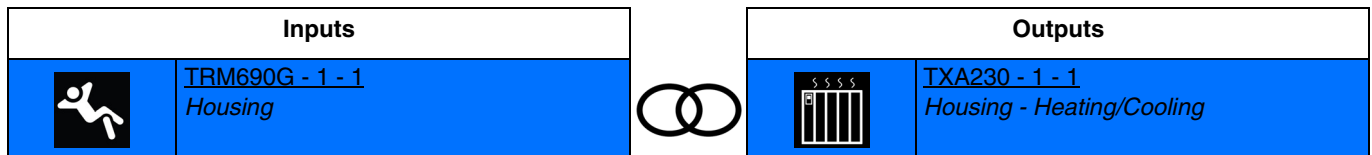

Closing the input contact activates Comfort mode.
The effect of the command is cancelled by any other mode activation command.

- **Eco mode:** Activates Eco mode for the heating.

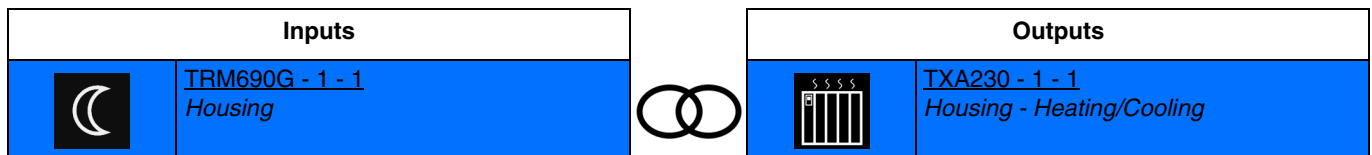

Closing the input contact activates Eco mode.
The effect of the command is cancelled by any other mode activation command.

- **Standby mode:** Activates StandBy mode for the heating.

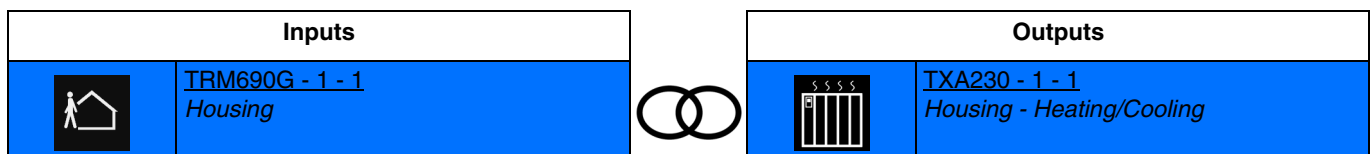

Closing the input contact activates StandBy mode.
The effect of the command is cancelled by any other mode activation command.

- **Protection mode:** Activates Protection mode for the heating.

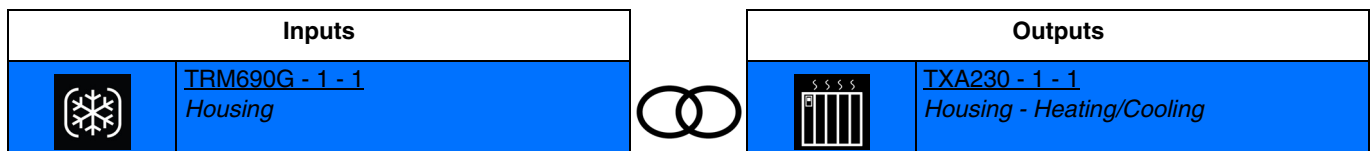

Closing the input contact activates Protection mode.
The effect of the command is cancelled by any other mode activation command.

- **Switch mode:** Switches between 2 heating modes.

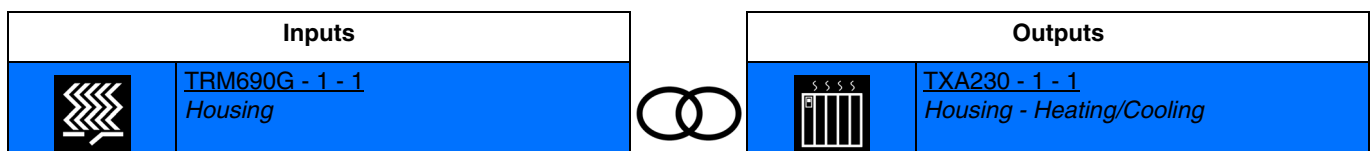

Closing the input contact activates heating mode 1.
Opening the input contact activates heating mode 2.
The effect of the command is cancelled by any other mode activation command.

Note: At the time of the connection, one must define the heating mode for input contact closing and opening.

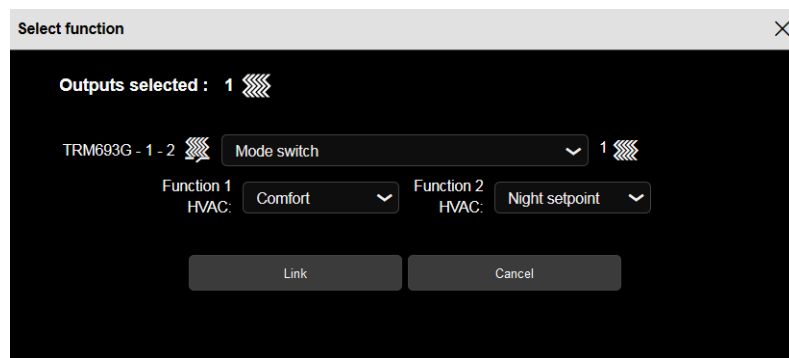

Heating mode available: **Auto**, **Comfort**, **Standby**, **Night setpoint** and **Freeze protection**.

Note: By default, the input operates like an NO contact (Normally open). If the parameter **Inverted** is validated, the input operates like an NC contact (Normally closed). This is valid for all heating modes.

Below are the outputs which can also have these functions:

	HVAC	Enables control of all heating zones.
--	------	---------------------------------------

It is also possible to make a link between 2 inputs. Below are the inputs which can also have these functions:

	HVAC control	Enables control of heating by zone.
	Setpoints heating	Enables the heating mode to be sent to the thermostat.

4.4.4.2 Heating/Cooling

- **Heating/Cooling**: Enables switching between heating mode and cooling mode. To do so, it is necessary to make a connection between two inputs.

Inputs	
	TRM690G - 1 - 1 Housing
	TXA460 - 1 - 5 Housing

Closing the input contact activates the heating mode.
Opening the input contact activates the cooling mode.

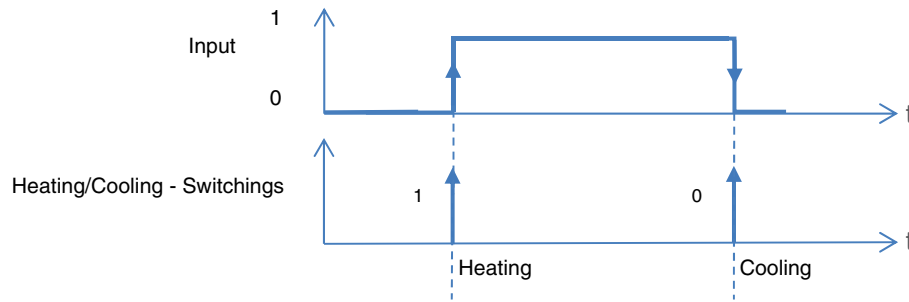

4.4.4.3 Priority

The Priority function forces a heating mode.

This function the priority or priority cancellation controls to be issued.

No other command is taken into account when the Priority is active. Only priority or alarm cancellation commands will be taken into account.

- **Comfort priority:** Activates and maintains Comfort mode.

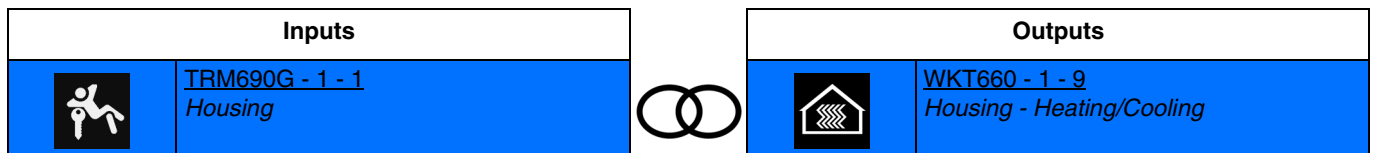

Closing the contact activates and maintains Comfort mode.

Closing the contact cancels the priority and returns to the usually active mode.

- **Protection priority:** Activates and maintains Protection mode.

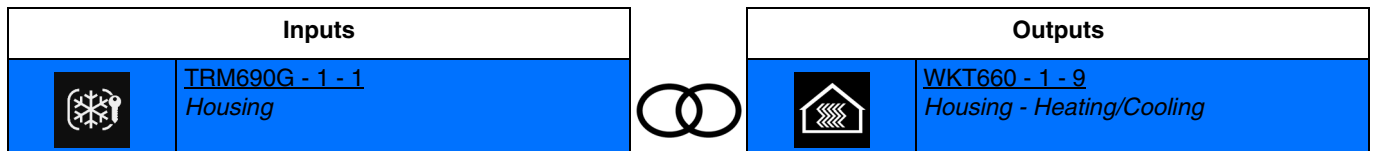

Activating the input forces the output to OFF.

Successive activation switches between OFF priority and priority cancellation.

It is also possible to make a link between 2 inputs. Below are the inputs which can also have these functions:

	Setpoints heating	Forces the heating mode for the thermostat.
--	-------------------	---

4.4.4.4 Heating automatic control

The Automatic control function enables the heating mode to be controlled in parallel to the standard control. An additional command object (Automatic control deactivation) is used to activate or deactivate Automatic control.

- **Comfort mode automatic control:** Activates Comfort mode for heating using automatic control.

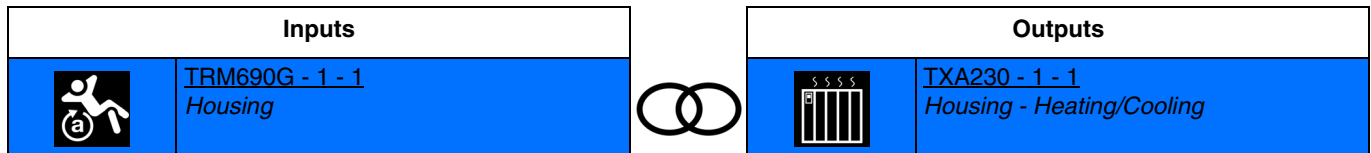

Closing the input contact activates Comfort mode.
The effect of the command is cancelled by any other mode activation command.

- **Eco mode automatic control:** Activates Eco mode for heating using automatic control.

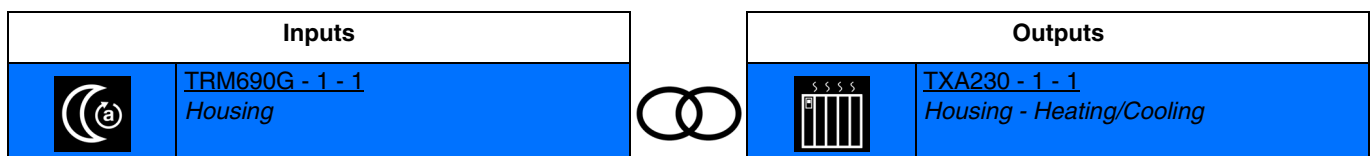

Closing the input contact activates Eco mode.
The effect of the command is cancelled by any other mode activation command.

- **Standby mode automatic control:** Activates StandBy mode for the heating using automatic control.

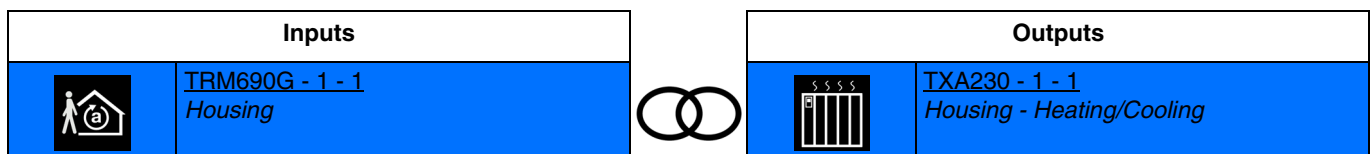

Closing the input contact activates StandBy mode.
The effect of the command is cancelled by any other mode activation command.

- **Protection mode automatic control:** Activates Protection mode for heating using automatic control.

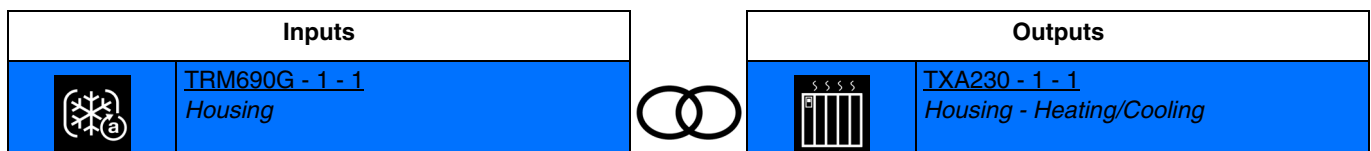

Closing the input contact activates Protection mode.
The effect of the command is cancelled by any other mode activation command.

- **Switch mode automatic control:** Switches between 2 heating modes using automatic control.

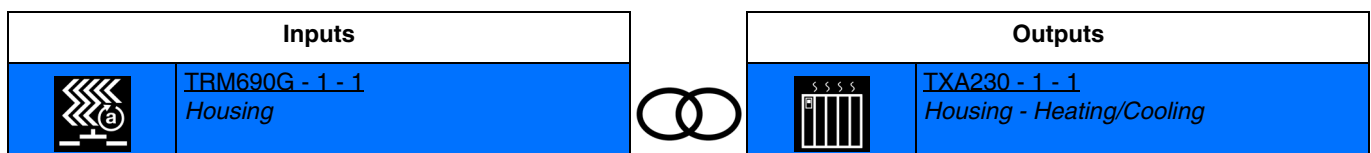

Closing the input contact activates heating mode 1.
Opening the input contact activates heating mode 2.
The effect of the command is cancelled by any other mode activation command.

Note: At the time of the connection, one must define the heating mode for input contact closing and opening.

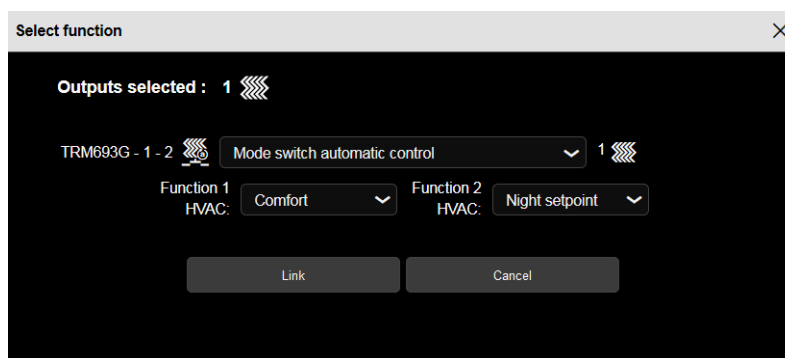

Heating mode available: **Auto, Comfort, Standby, Night setpoint** and **Freeze protection**.

Note: By default, the input operates like an NO contact (Normally open). If the parameter **Inverted** is validated, the input operates like an NC contact (Normally closed). This is valid for all heating modes.

Below are the outputs which can also have these functions:

	HVAC	Enables control of all heating zones.
--	------	---------------------------------------

It is also possible to make a link between 2 inputs. Below are the inputs which can also have these functions:

	HVAC control	Enables control of heating by zone.
	Setpoints heating	Enables the heating mode to be sent to the thermostat.

4.4.4.5 Metering

Available functionalities			
	Tariff		Scene
	Automatic control deactivation		Scene switch

Note: For the function **Automatic control deactivation**, see: [Automatic control deactivation](#).
For the function **Scene** and **Switch scene**, see: [Scene](#).

- **Tariff**: Sends information about Full Hour (FH) tariff or Part Hour (PH) tariff.

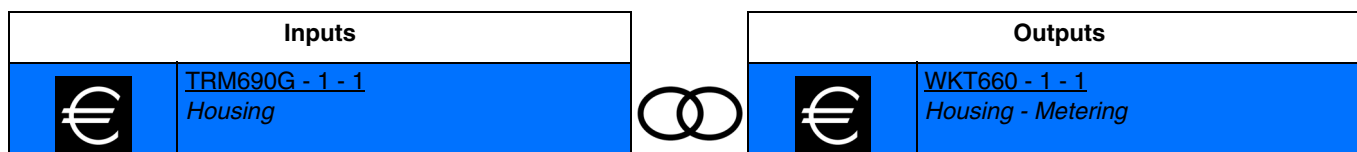

Closing the input contact sends the Full Hour (FH) tariff.
Opening the input contact sends the Part Hour (PH) tariff.

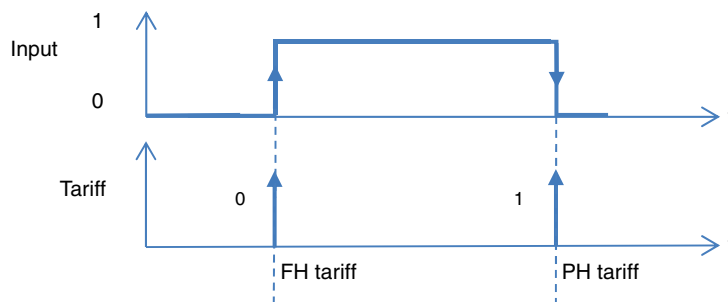

Note: By default, the input operates like an NO contact (Normally open). If the parameter **Inverted** is validated, the input operates like an NC contact (Normally closed).

It is also possible to make a link between 2 inputs. Below are the inputs which can also have these functions:

	Energy	Transmits tariff information to the metering input.
--	--------	---

4.4.5 Automatic control deactivation

The Automatic control function enables an output to be controlled in parallel to the standard control. An additional command object (Automatic control deactivation) is used to activate or deactivate Automatic control.

- **Automatic control deactivation:** Deactivates automatic control.

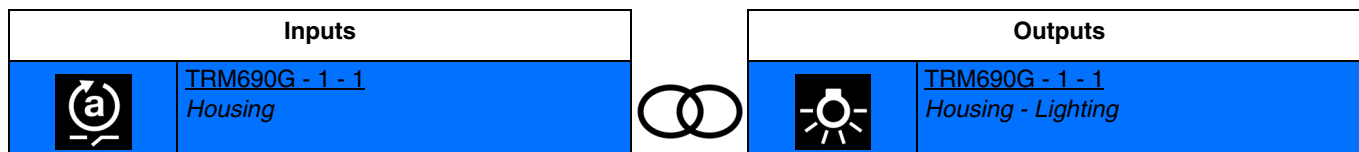

Closing the input contact deactivates automatic control.
Opening the input contact activates automatic control.

Note: By default, the input operates like an NO contact (Normally open). If the parameter **Inverted** is validated, the input operates like an NC contact (Normally closed).

Below is the list of outputs where deactivation of automatic control is possible.

	Lighting		Dimming
	Shutter/blind		Shading control

Deactivating automatic control is also possible on the input.

	Setpoints heating
--	-------------------

4.4.6 Scene

This function enables scenes to be saved or selected. These concern different types of output (lighting, blind, shutter, heating) to create ambiances or scenarios (leaving scenario, reading ambiance etc.).

- **Scene:** The scene is activated by pressing the push-button.

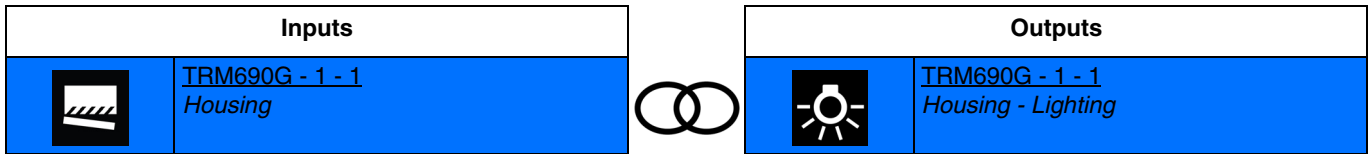

Activating the input activates the scene.

Note: At the time the connection is made, the scene number must be defined for the closing input contact.

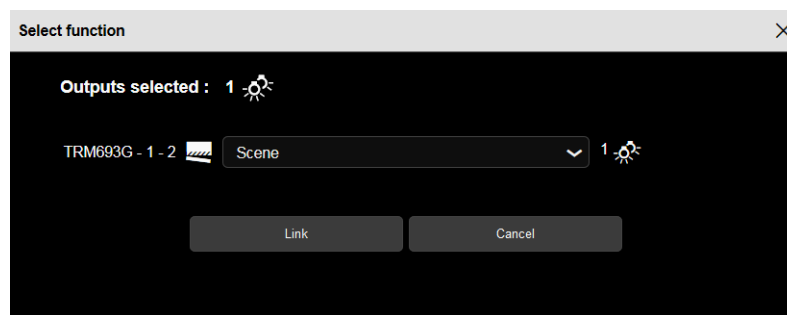

*Note: By default, the input operates like an NO contact (Normally open). If the parameter **Inverted** is validated, the input operates like an NC contact (Normally closed).*

- **Scene switch:** The scene is activated according to the closing or opening input contact.

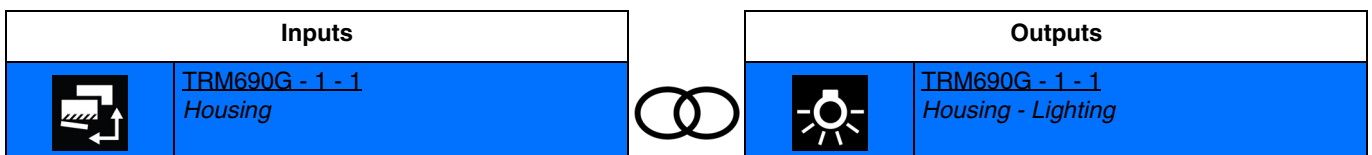

Closing the input contact activates scene 1.

Closing the input contact activates scene 2.

Note: At the time the connection is made, the scene number must be defined for the closing and opening input contact.

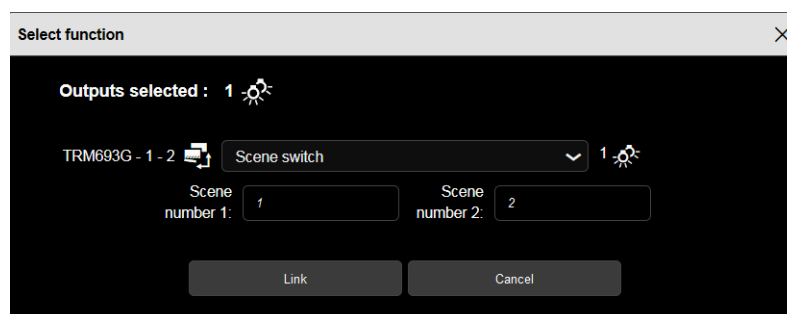

*Note: By default, the input operates like an NO contact (Normally open). If the parameter **Inverted** is validated, the input operates like an NC contact (Normally closed).*

Below is the list of outputs where the scene is possible.

	Lighting		Dimming
	Shutter/blind		CMV

The scene is also possible on the input.

	Increase/decrease dimming (Only with TX511 and TXC511)		Setpoints heating
--	--	--	-------------------

5. Factory reset

This function enables the device to be returned to its initial configuration (configuration when it came out of the factory). After a device reset, the device can be re-used in a new installation. A factory reset can be performed either directly on the product or by the media coupler plug-in. This last solution is recommended if the product is part of an installation configured by ETS, thus the device is erased from the project.

5.1 Factory reset by ETS via the media coupler

- For a product which is part of the installation (known by the media coupler): In the **Physical addressing** menu, select **Factory reset** and then follow the instructions which appear on the screen.
- For a product which is not part of the installation (unknown by the media coupler): In the menu **Physical addressing**, select **RESET device out of installation**, then **Unidirectional device with Addr. button**.

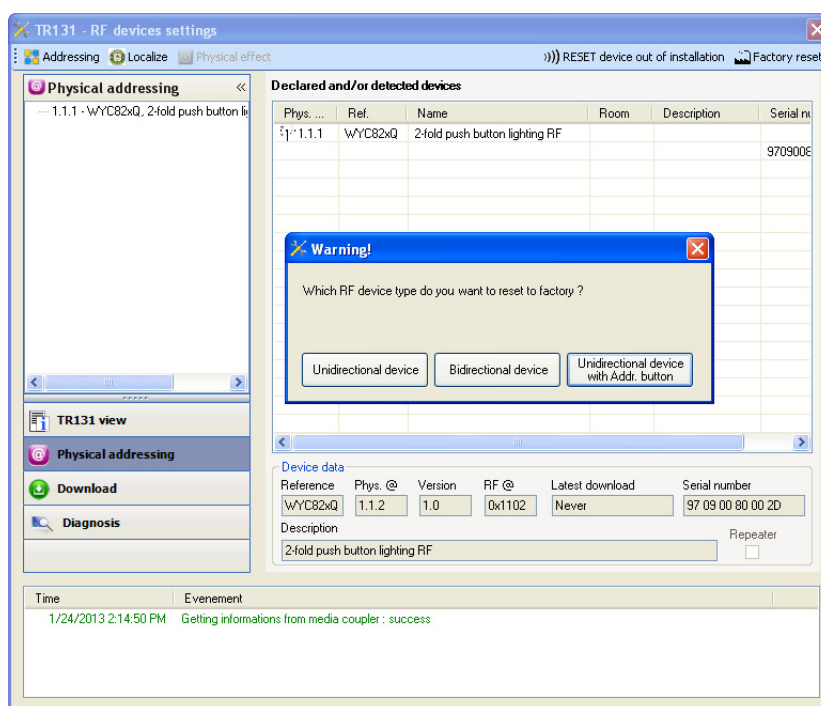

5.2 Factory reset on the product

It is always possible to perform the factory reset directly on the device.

Factory reset on the product:

- Do a long key press (> 10 seconds) on the **cfg** push button, release the button when the **cfg** LED blinks.
- Wait for the **cfg** LED to switch off, indicating that the factory reset has been completed.

Remark:

To re-use a product which has already been programmed in another installation, whatever the configuration mode, a factory reset must be performed on the product.

6. Characteristics

Device	TRM690G	TRM693G	TRM694G
Max. number of group addresses	83	83	83
Max. number of allocations	90	90	90

